

2013 / 2014

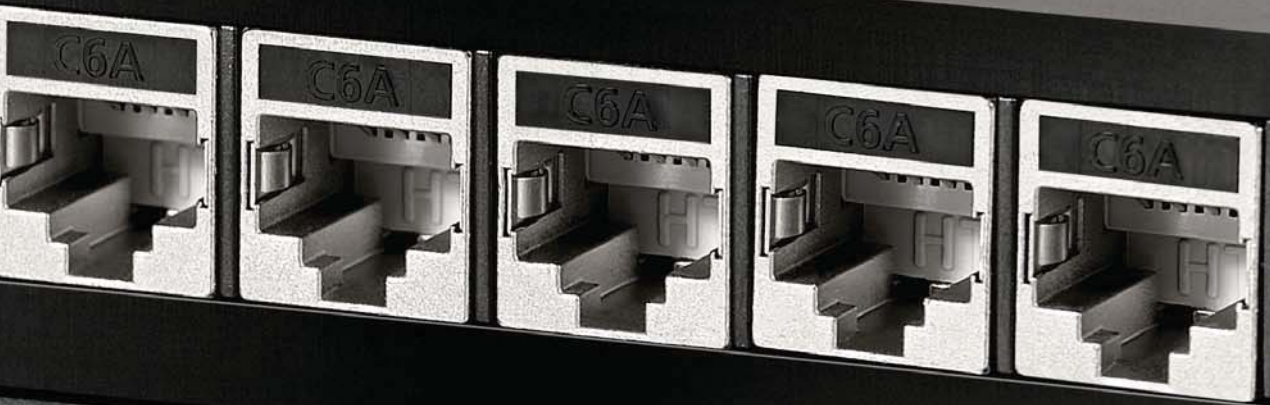

Connectivity Product Catalogue

Better Technology through Innovation

HellermannTyton



1 RapidNet
Pages 14 - 68



3 Data Outlets
Pages 100 - 126



2 Patch Panels
Pages 70 - 98



4 Fibre
Pages 128 - 146

Contents



5 Cable

Pages 148 - 166



7 iD

Pages 194 - 198



6 Accessories

Pages 168 - 192



8 Appendix

Pages 200 - 210



Delivering quality structured cabling solutions

HellermannTyton is an established and innovative leader in the provision of global network infrastructure solutions, offering a broad range of quality, high performance structured cabling products. Our extensive product range includes a number of different options for Category 6A, Category 6 and Category 5e systems as well as our world leading pre-terminated RapidNet system.

With a wide range of fibre closures and fibre management options, including the Integrated Routing System, HellermannTyton's provision of solutions to the broadband and Fibre to the X (FTTX) sector has gone from strength to strength.

We are part of the global HellermannTyton group, who are market leaders in cable management serving the communications, construction, utility, automotive and aerospace markets and have operations in 34 countries around the world.

Why choose HellermannTyton for your Network Cabling needs?

- The UK's largest manufacturer producing over three million system points annually.
- ISO 9001:2008 quality certification and ISO 14001:2004 environmental management accreditation.
- Open, responsive and accessible personnel at all levels.
- BICSI registered training available (up to 13 credits).
- On-site design and technical facilities allow us to remain flexible, enabling us to adapt and design products quickly - crucial in today's rapidly changing markets.
- Wide range of reference sites across major industries including finance, education, government and health.
- We are passionate about putting our customers first and pride ourselves on being easy to do business with.

History Timeline

- 1988 Established in Northampton as RW Data
- 2000 Acquired by global company HellermannTyton
- 2003 Launch of innovative pre-terminated RapidNet system
- 2005 Launch of iD - Intelligent Infrastructure Management
- 2007 Launch of iD Active hardware
- 2008 HellermannTyton Broadband Systems move from Plymouth to Northampton
- 2008 Launch of Deca¹⁰ – The Category 6A and Fibre range to support 10G systems
- 2010 Launch of MTP VHD RapidNet and 12 Port RapidNet products
- 2011 Introduced Extended FDN and Pre-Tubed closures into BBS Broadband
- 2012 Launch of Broadband Integrated Routing System
- 2012 Introduced 144 core MTP VHD products

To truly excel, you need to keep improving all the time

Our Corporate Philosophy

Moving the market takes more than good ideas.

Developing the product solutions for the future, requires visionary thinking and the passion to turn ideas into reality.

When visions become functional products, innovations are generated that benefit our customers.

We create the conditions for this by employing motivated people who are committed to working as a team. When only the best solutions will do, you need dedicated professionals with expert knowledge.

The resulting product solutions not only shape the market but also develop it.

We are able to offer product solutions before our customers know they need them.

We maintain good relationships with our customers and also keep a close eye on the latest market developments. This allows us to recognise trends affecting trade and industry at an early stage. And enables us to remain a step ahead of customer requirements at all times.

Meeting high expectations calls for ongoing development.

As well as paying particular attention to communicating with our customers and knowledge of the market, we invest heavily in research and development. To ensure that we can support our customers into the future by offering custom product solutions, we continually optimise our technical and logistical processes.

At your service wherever – and whenever – you need us.

What use are the best product solutions if they are not available to local markets in a timely way? HellermannTyton's motto is therefore "Think global, act local". For us, this not only means responding to the needs of local markets – we also have a presence there for the benefit of our customers.

Employees on the ground allow us to cater for cultural, market-specific and linguistic factors effectively. In addition, our customers have access to a worldwide distribution network. This adds value that makes us one of the leading providers for trade and industry.

Certified processes and quality, for your security.

HellermannTyton always aim for the highest quality. To live up to this claim we have implemented both quality and environmental management systems.

Our quality management is certified to ISO 9001:2008.

In addition, our environmental management complies with the requirements of ISO 14001:2004.





Our Development Competence

Innovative product solutions need a solid basis: Three working methods that characterise our design competence.

What does it really take to make an innovative product solution? Put simply, it consists of an idea that leads to products with an added value that is completely new for you. What this highlights clearly is in fact a complex undertaking in which many factors must interact with each other. This is why HellermannTyton uses three working methods to guarantee that development, quality, production and distribution of technically demanding solutions are guaranteed at the highest level.

1 Customer specific product developments.

The most important requirement of all for developing made-to-measure products is established through direct dialogue with our customers. It is on this basis that we develop innovative solutions which meet your high requirement profile.

Our Engineers work closely together in a worldwide network. This is how they can achieve not only optimal synergies, but also a service and support quality which you will find nowhere else.

2 Development of market leading all-purpose products.

We not only invest continuously in research and development, but also closely scrutinise our entire product portfolio.

Intensive market and competition analysis enable us to spot market and processing trends ahead of time. This is why our products always meet your high expectations and special requirements.

3 Reengineering of existing products.

By reengineering our products, we mean the constant optimisation of our wide-ranging portfolio. Close co-operation with you, the distributors and end-users of our products, allows us to continuously adjust our existing products to meet up-to-date market trends. This consequent development and modernisation of our products and processes makes ourselves a reliable partner, onwards into the future.

Reduce Installation times by up to 85%

RapidNet Pre-terminated Solutions

RapidNet

RapidNet, the world's leading pre-terminated cabling system from HellermannTyton provides the perfect solution for installations of any size. Available in both fibre and copper, adopting a RapidNet installation for your project can reduce installation time by up to 85%.

High Density

Because RapidNet is factory pre-terminated and pre-tested, there is minimal engineering work required once the product arrives on site. The RapidNet concept is based on an innovative and fully patented cassette that hosts the pre-terminated fibre or copper connections. Each fibre cassette can offer up to 144 fibres with MTP VHD, whilst the copper cassette can offer up to 12 RJ45 ports using the 12 port cassette or 6 RJ45 ports using the standard copper cassette.

Simple to Install

The cassettes simply plug into the RapidNet 19" panel that hosts 4 cassettes providing the standard 24 ports per U in copper or up to 576 fibres in the MTP VHD fibre version. HellermannTyton also offer a 4 port cassette and 12 port cassette providing 24 or 48 ports in 1U of rack space.

Common Applications

The most common application for RapidNet is cabinet to cabinet and cabinet to patching field. This is where RapidNet occupies a unique position and is in a league of its own. By utilising the cassette to cassette version, with the cabled loom cut to a specified length, the cassette is simply inserted into each cabinet or rack mounted patch panel in a simple and easy action. The cable that runs between the cassettes is either placed in the under floor or ceiling voids or in overhead basket trays depending on your environment.

Environmentally Friendly

RapidNet delivers environmental benefits as soon as it's specified. Firstly, it's manufactured in the UK, so from the minute it leaves the ISO 14001 accredited factory in Northampton its carbon foot print is minimal. RapidNet is pre-terminated and where specified made to exact lengths. This cuts down on large amounts of waste cable, on-site and at the HellermannTyton factory. Where possible, RapidNet is supplied on re-usable plastic drums again cutting down on waste packaging.

RapidNet



Broadband Systems

Telecom Fibre Solutions

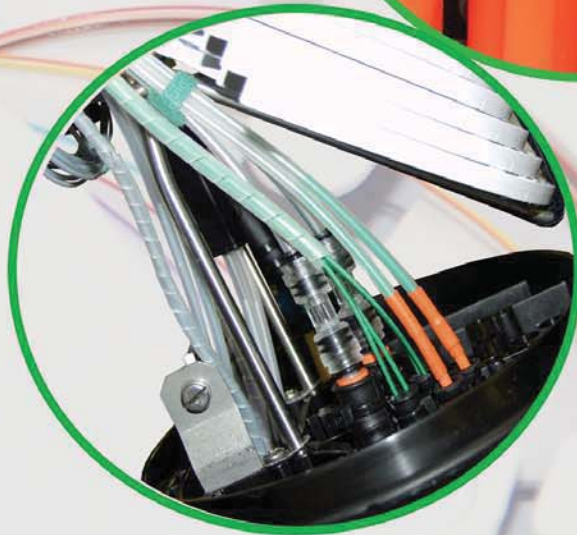

HellermannTyton Broadband Systems – At the leading edge of Fibre Management

HellermannTyton is an established and innovative global leader in the provision of network infrastructure cabling solutions, offering a broad range of quality, high performance connectivity for both residential and commercial use.

HellermannTyton's Broadband Systems comprise a unique range of fibre splicing closures that are found in any typical external broadband fibre optic network.

The sealed closures from HellermannTyton protect the fibre management systems from adverse environmental conditions whilst maintaining ready access for effective cable installation. The fibres are housed in space saving modular units that minimise network disruption and have been designed to allow further modules to be added at a later date for increased capacity, ensuring a future proof design.

More customers are demanding maximum flexibility and a modular approach to cable management systems that will fit into existing and future networks. All closures have therefore been designed to cater for this requirement to accommodate the wide variety of fibre optic cables that are now available including slotted core, loose tube, compact, ribbon and blown fibre/cable applications.

Training

HellermannTyton offer a range of comprehensive training courses, held in specially equipped training rooms at the Northampton manufacturing facility.

There are currently three LAN structured cabling courses to choose from:

- 1 day Category 6A course,
- 2 day Fibre course
- 1 day Category 6/Category 5e Practitioners course.

All three of the courses are BICSI approved and carry BICSI credits (CEC's) on completion of the course for all registered RCDD's, Installers and Technicians. The Fibre Installation course carries 13 points; the Category 6A course carries 6 points as does the Category 6/Category 5e course.

The closures have been designed to meet customers' demands for various fibre management systems including single circuit, single element, multiple element and cross connectivity. Tray design is evolving to meet the needs of bend insensitive fibres, for which the Hellipse™ NZDF range has been developed, for increased fibre storage capacity, the ability to change direction of the fibres and to cater for the various types of splice protectors and PON devices that are now available in the global market.

HellermannTyton manufacture a wide range of fibre closures that can be applied across all areas of FTTH applications. Many of the sealed closures lend themselves to a PON architecture allowing up to 864 fibres in the largest UFC closure all the way down to 36 fibres with the FST closure. All of the closures from HellermannTyton offer flexibility and access so that more fibre can be added in the future (up to their maximum capacity). All of the closures are compatible with Cablelok™, HellermannTyton's 100% mechanical seal, or heat-shrink can be used as an alternative sealing method.



HellermannTyton are members of the FTTH Council Europe



HellermannTyton are members of the Fibreoptic Industry Association (FIA)

On completion of the HellermannTyton training courses, attending installers are then qualified as approved HellermannTyton installers and are able to offer the 25 year warranty on their network installation work through HellermannTyton.

Product and installation training for our range of broadband closures is also available.

More information on HellermannTyton training courses available on request.



HellermannTyton are members of BICSI

Wherever you need us...

Think global, act local

If you have a particular problem that you would like us to help you with then please contact us.

With our vast experience and practically unlimited technical capabilities we are confident of being able to help you find a solution.

Remember, we are a service provider and not just a supplier.

Give us a call! Here are your contacts for enquiries and orders

For all product information please visit our Website www.htdata.co.uk



Contact us

HellermannTyton Data

Cornwell Business Park
Salthouse Road
Brackmills
Northampton
NN4 7EX
United Kingdom

General Enquiries Tel: +44 (0) 1604 706633
Sales Tel: +44 (0) 1604 707420
Fax: +44 (0) 1604 705454
email: sales@htdata.co.uk
web: www.htdata.co.uk

Europe

HellermannTyton GmbH – Austria

Obachgasse 6
1221 Vienna
Tel: +43 (0) 1 259 99 55 - 0
Fax: +43 (0) 1 259 99 11
E-Mail: office@HellermannTyton.at
www.HellermannTyton.at

HellermannTyton – Czech Republic

E-Mail: office.cz@HellermannTyton.at
www.HellermannTyton.cz

HellermannTyton Denmark

Baldersbuen 15D 1. TV
2640 Hedehusene
Tel: +45 702 371 20
Fax: +45 702 371 21
E-Mail: htdk@HellermannTyton.dk
www.HellermannTyton.dk

HellermannTyton Oy – Finland

Sähkötie 8
01510 Vantaa
Tel: +358 9 8700 450
Fax: +358 9 8700 4520
E-Mail: myynti@HellermannTyton.fi
www.HellermannTyton.fi

HellermannTyton S.A.S. – France

2 rue des Hêtres, B.P. 130
78196 Trappes Cedex
Tel: +33 1 30 13 80 00
Fax: +33 1 30 13 80 60
E-Mail: info@HellermannTyton.fr
www.HellermannTyton.fr

HellermannTyton GmbH – Germany

Großer Moorweg 45
25436 Tornesch
Tel: +49 4122 701-0
Fax: +49 4122 701-400
E-Mail: info@HellermannTyton.de
www.HellermannTyton.de

HellermannTyton KFT – Hungary

Kisfaludy u. 13
1044 Budapest
Tel: +36 1 369 4151
Fax: +36 1 369 4151
E-Mail: office@HellermannTyton.hu
www.HellermannTyton.hu

HellermannTyton S.r.l. – Italy

Via Praimbole 9 Bis
35010 Limena (PD)
Tel: +39 049 767 870
Fax: +39 049 767 985
E-Mail: info@HellermannTyton.it
www.HellermannTyton.it

HellermannTyton Ltd – Ireland

Unit 77 Cherry Orchard
Industrial Estate
Ballyfermot, Dublin 10
Tel: +353 1 626 8267
Fax: +353 1 626 8022
E-Mail: sales@HellermannTyton.ie
www.HellermannTyton.co.uk

HellermannTyton B.V. – Belgium/Netherlands

Vanadiumweg 11-C
3812 PX Amersfoort
Tel: +31 (0) 33 460 06 90
Fax: +31 (0) 33 460 06 99
E-Mail (NL): info@HellermannTyton.nl
E-Mail (BE): info@HellermannTyton.be
www.HellermannTyton.nl
www.HellermannTyton.be

HellermannTyton AS – Norway

PO Box 240 Alnabru
0614 Oslo
Tel: +47 23 17 47 00
Fax: +47 22 97 09 70
E-Mail: firmapost@HellermannTyton.no
www.HellermannTyton.no

HellermannTyton – Poland

E-Mail: info@HellermannTyton.pl
www.HellermannTyton.pl

OOO HellermannTyton – Russia

40/4, Pulkovskoe road.,
BC Technopolis Pulkovo, office A 8081
196158, St.Petersburg
Tel: +7 812 386 00 09
Fax: +7 812 386 00 08
E-Mail: info@HellermannTyton.ru
www.HellermannTyton.ru

HellermannTyton – Slovenia

Branch Office Ljubljana
Podružnica Ljubljana, Leskoškova 6
1000 Ljubljana
Tel: +386 1 433 70 56
Fax: +386 1 433 63 21
E-Mail: sales@HellermannTyton.si
www.HellermannTyton.si

HellermannTyton España s.l. – Spain/Portugal

Avda. de la Industria nº 37, 2º 2º
28.108 Alcobendas, Madrid
Tel: +34 91 661 2835
Fax: +34 91 661 2368
E-Mail:
HellermannTyton@HellermannTyton.es
www.HellermannTyton.es

HellermannTyton AB – Sweden

Datavägen 5, PO Box 569
17526 Järfälla
Tel: +46 8 580 890 00
Fax: +46 8 580 890 01
E-Mail: support@HellermannTyton.se
www.HellermannTyton.se

HellermannTyton Ltd – UK

William Prance Road
Plymouth International Medical and
Technology Park
Plymouth
Devon
PL6 5WR
Tel +44 (0) 1752 701 261
Fax +44 (0) 1752 790 058
E-Mail: info@HellermannTyton.co.uk
www.HellermannTyton.co.uk

HellermannTyton Ltd – UK

Sharston Green Business Park
1 Robeson Way
Altrincham Road, Wythenshawe
Manchester M22 4TY
Tel: +44 161 947 2200
Fax: +44 161 947 2220
E-Mail: sales@HellermannTyton.co.uk
www.HellermannTyton.co.uk

HellermannTyton Ltd – UK

Main Contact for Customer Service
Wharf Approach
Aldridge, Walsall, West Midlands
WS9 8BX
Tel: +44 1922 458 151
Fax: +44 1922 743 237
E-Mail: info@HellermannTyton.co.uk
www.HellermannTyton.co.uk

HellermannTyton Data Ltd – UK

Cornwell Business Park
Salthouse Road, Brackmills
Northampton NN4 7EX
Tel: +44 1604 707 420
Fax: +44 1604 705 454
E-Mail: hns@htdata.co.uk
www.htdata.co.uk

North America

HellermannTyton – Canada

Tel: +1 905 726 1221
Fax: +1 905 726 8538
E-Mail: sales@HellermannTyton.ca
www.HellermannTyton.ca

HellermannTyton – Mexico

Tel: +52 333 133 9880
Fax: +52 333 133 9861
E-Mail:
info@HellermannTyton.com.mx
www.HellermannTyton.com

HellermannTyton – USA

Tel: +1 414 355 1130
Fax: +1 414 355 7341
E-Mail: corp@htamericas.com
www.HellermannTyton.com

South America

HellermannTyton – Argentina

Tel: +54 11 4754 5400
Fax: +54 11 4752 0374
E-Mail:
ventas@HellermannTyton.com.ar
www.HellermannTyton.com.ar

HellermannTyton – Brazil

Tel: +55 11 4815 9000
Fax: +55 11 4815 9030
E-Mail:
vendas@HellermannTyton.com.br
www.HellermannTyton.com.br

Asia-Pacific

HellermannTyton – Australia

Tel: +61 2 9525 2133
www.HellermannTyton.com.au
Fax: +61 2 9526 2495
E-Mail:
cservice@HellermannTyton.com.au
www.HellermannTyton.com.au

HellermannTyton – China

Tel: +86 510 8528 2536
Fax: +86 510 8528 2731
E-Mail:
cservice@HellermannTyton.com.cn
www.HellermannTyton.com.cn

HellermannTyton – Hong Kong

Tel: +852 2832 9090
Fax: +852 2832 9381
E-Mail:
cservice@HellermannTyton.com.hk
www.HellermannTyton.com.sg

HellermannTyton – India

Tel: +91 11-2620 9230/6661 9230
Fax: +91 11-2620 9330/6661 9330
E-Mail:
cservice@HellermannTyton.co.in
www.HellermannTyton.co.in

HellermannTyton – Japan

Tel: +81 3 5790 3111
Fax: +81 3 5790 3112
E-Mail:
cservice@HellermannTyton.co.jp
www.HellermannTyton.co.jp

HellermannTyton – Korea

Tel: +82 2 2614 0157
Fax: +82 2 2614 0284
E-Mail:
cservice@HellermannTyton.co.kr
www.HellermannTyton.co.kr

HellermannTyton – Philippines

Tel: +63 2 752 6551
Fax: +63 2 752 6553
E-Mail:
cservice@HellermannTyton.com.ph
www.HellermannTyton.com.ph

HellermannTyton – Singapore

Tel: +65 6 852 8585
Fax: +65 6 756 6798
E-Mail: cservice@HellermannTyton.sg
www.HellermannTyton.com.sg

HellermannTyton – Thailand

Tel: +66 2 237 6702
Fax: +66 2 266 8664
E-Mail:
cservice@HellermannTyton.com.th
www.HellermannTyton.com.sg

Africa

HellermannTyton – South Africa





Tel: +27 11 879 6680
Fax: +27 11 879 6601
E-Mail: sales.jhb@Hellermann.co.za
www.HellermannTyton.co.za

Easy Product Navigation



In order to help you find the right products for your network infrastructure, we have made identification easier by using the following category labelling system.

HellermannTyton manufacture products for a full end to end system including Patch Panels, Data Outlets, Patch Leads and Cable. HellermannTyton also manufactures the world-leading RapidNet system that can also be found using the category symbols below.

	Find this performance standard in...	Pages:
For Category 6A products look for this symbol:	 <ul style="list-style-type: none"> Chapter 1.1 RapidNet Copper Chapter 2.1 Patch Panels Chapter 3.1 Data Outlets Chapter 5.1 Bulk Copper Cable Chapter 5.2 Patch Leads 	<ul style="list-style-type: none"> 14-17 70-71 100 148 152
For Category 6 products look for this symbol:	 <ul style="list-style-type: none"> Chapter 1.1 RapidNet Copper Chapter 2.2 Patch Panels Chapter 3.2 Data Outlets Chapter 5.1 Bulk Copper Cable Chapter 5.2 Patch Leads 	<ul style="list-style-type: none"> 18-32 72-82 101-111 148-150 153-155
For Category 5e products look for this symbol:	 <ul style="list-style-type: none"> Chapter 1.1 RapidNet Copper Chapter 2.3 Patch Panels Chapter 3.3 Data Outlets Chapter 5.1 Bulk Copper Cable Chapter 5.2 Patch Leads 	<ul style="list-style-type: none"> 33-42 83-96 112-125 150-152 155-160
For Category 3 products look for this symbol:	 <ul style="list-style-type: none"> Chapter 2.4 Patch Panels Chapter 3.4 Data Outlets 	<ul style="list-style-type: none"> 97-98 126



1 RapidNet

	Page		Page		Page
1.1 RapidNet Copper		RapidNet 4 Port Category 5e		RapidNet Fibre SC 12 Core	
RapidNet 6 Port Category 6A		Cassette to Cassette	38	Cassette to Cassette	59
Cassette to Cassette	14	Cassette to Keystone Jack	39	Cassette with 1 Rear MTP Connector	60
Cassette to Keystone Jack	15	Cassette to RJ45 Plug	40	Cassette to SC Fan Out	61
Cassette to RJ45 Plug	16	Cassette to Pod	41		
Cassette to Bare End	17	Cassette to Bare End	42	1.3 RapidNet Accessories	
RapidNet 12 Port Category 6		1.2 RapidNet Fibre		12 Port Cassette Panel	62
Cassette to Cassette	18	RapidNet MTP VHD 144 Core		6 Port Copper/Fibre Cassette Panel	62
Cassette to RJ45 Fan Out	19	6 MTP Cassette to Cassette	43	6 Port Cassette Shielded Panel	63
Cassette to Split Cassette	20	12 MTP Cassette to Cassette	44	4 Port Cassette Panel	63
Cassette to Split Pod	21	6 MTP Cassette to MTP Fan Out	45	Rear Cable Management Panel	64
Cassette to Bare End	22	12 MTP Cassette to MTP Fan Out	46	Hybrid Panel	64
RapidNet 6 Port Category 6		RapidNet MTP VHD 72 Core		Category 6 RapidNet Clips	65
Cassette to Cassette	23	6 MTP Cassette to Cassette	47	Category 5e RapidNet Clips	65
Cassette to Keystone Jack	24	6 MTP Cassette to MTP Fan Out	48	RapidNet Blanks	66
Cassette to RJ45 Plug	25	6 MTP Cassette to LC Fan Out	49	RapidNet Floor Boxes	66
Cassette to Pod	26	RapidNet Fibre LC 24 Core		RapidNet Mesh	67
Cassette to Bare End	27	Cassette to Cassette	50	RapidNet Trolley	67
RapidNet 4 Port Category 6		Cassette with 2 Rear MTP Connectors	51		
Cassette to Cassette	28	Cassette with 1 Rear MTP Connector	52		
Cassette to Keystone Jack	29	Cassette to LC Fan Out	53		
Cassette to RJ45 Plug	30	Cassette to SC Fan Out	54		
Cassette to Pod	31	RapidNet Fibre LC 12 Core			
Cassette to Bare End	32	Cassette to Cassette	55		
RapidNet 6 Port Category 5e		Cassette with 1 Rear MTP Connector	56		
Cassette to Cassette	33	Cassette to LC Fan Out	57		
Cassette to Keystone Jack	34	Cassette to SC Fan Out	58		
Cassette to RJ45 Plug	35				
Cassette to Pod	36				
Cassette to Bare End	37				



RapidNet Category 6A

Cassette to Cassette

Features and Benefits

- Exceeds Category 6A performance standards
- Factory pre-terminated and tested
- Reduce installation times by up to 85%
- Ideal solution for cabinet to cabinet installations
- Backward compatible with Category 6, Category 5e, Category 5 and voice

6A



High Performance Category 6A Cassette to Cassette RapidNet solution

Product Description

The Deca¹⁰ Cassette to Cassette is pre-terminated with 6 Deca¹⁰ Keystone Jacks earthed to a plate within the cassette. The earth plate in the cassette then makes contact with the earth points on the RapidNet Panel. The Deca¹⁰ Cassette is manufactured with a simple push clip mechanism and polarising pips to prevent incorrect insertion.

The Cassette to Cassette option is specifically designed for inter-cabinet installations that are common in data centre environments.

Technical Data Table

Article-No.	Type	Performance Category	Height (H)	Width (W)	Depth (D)	Length (L)	Port count	Colour
859-50019	RN06G6A-CACAXX-10.0M	Category 6A (Class EA)	31.0	107.0	130.0	10.0 m	6	Violet (VT)

All dimensions in mm. Subject to technical changes.

Technical Description

The Deca¹⁰ Copper solution is designed using U-FTP Category 6A cable which provides 360° shielding and eliminates alien crosstalk.

The 6 port Deca¹⁰ Cassette presents 6 RJ45 ports in one cassette, with 4 cassettes fitting into the standard Deca¹⁰ RapidNet Patch Panel. The cassettes simply push into the panel, snapping in with a releasable clip. A fully loaded panel presents the standard 24 ports in 1U of space.

The integral earthing plate grounds each Keystone Jack helping to guarantee 10G performance by giving continuity of the 360° shielding.

All RapidNet Category 6A cables are made with LSOH material, complying with the latest European fire ratings.

NB. Part Number is given for a 10m loom as an example. Lengths are available from 5m to 90m.

Technical Drawings

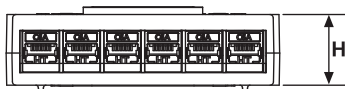

Front view of 6 port Category 6A Cassette

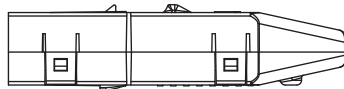

Side view of 6 port Category 6A Cassette

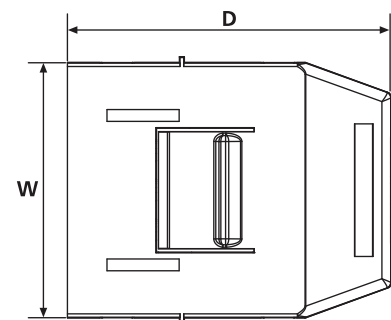

Top view of 6 port Category 6A Cassette



RapidNet Category 6A Cassette to Keystone Jack

Features and Benefits

- Exceeds Category 6A performance standards
- Factory pre-terminated and tested
- Ideal solution for 'to the desk' installations
- Compatible with angled Alpha Snap and 6C Modules
- Can fit in both floor boxes and wall boxes

6A



The Category 6A Keystone Jack fits into the angled module from HellermannTyton

Product Description

The Deca¹⁰ Cassette to Keystone Jack is pre-terminated with 6 Deca¹⁰ Keystone Jacks earthed to a plate within the cassette. The earth plate in the cassette then makes contact with the earth points on the RapidNet Panel. The Deca¹⁰ Cassette is manufactured with a simple push clip mechanism and polarising pips to prevent incorrect insertion.

The 6 port RapidNet Cassette to Keystone Jack option gives installers and end users added flexibility at the desk or 'work area' end.

The Keystone Jack can be easily clipped into a selection of modules that can be fitted into floor boxes or wall mounted in face plates.

Technical Data Table

Article-No.	Type	Performance Category	Height (H)	Width (W)	Depth (D)	Length (L)	Port count	Colour
859-35541	RN06G6A-CAKJXX-10.0M	Category 6A (Class EA)	31.0	107.0	130.0	10.0 m	6	Violet (VT)

All dimensions in mm. Subject to technical changes.

Technical Description

The Deca¹⁰ Copper solution is designed using U-FTP Category 6A cable which provides 360° shielding and eliminates alien crosstalk.

The 6 port Deca¹⁰ Cassette presents 6 RJ45 ports in one cassette, with 4 cassettes fitting into the standard Deca¹⁰ RapidNet Patch Panel. The cassettes simply push into the panel, snapping in with a releasable clip. A fully loaded panel presents the standard 24 ports in 1U of space.

The integral earthing plate grounds each Keystone Jack helping to guarantee 10G performance by giving continuity of the 360° shielding.

All RapidNet Category 6A cables are made with LSOH material, complying with the latest European fire ratings.

NB. Part Number is given for a 10m loom as an example. Lengths are available from 5m to 90m.

Technical Drawings

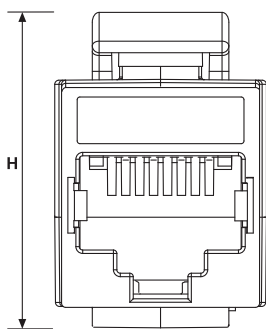

Front view of Category 6A shielded Keystone Jack

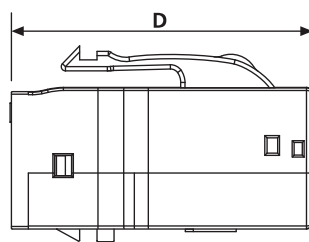

Side view of Category 6A shielded Keystone Jack

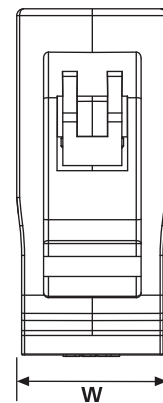

Top view of Category 6A shielded Keystone Jack



RapidNet Category 6A

Cassette to RJ45 Plug

Features and Benefits

- Exceeds Category 6A performance standards
- Factory pre-terminated and tested
- Reduce installation times by up to 85%
- Ideal solution when connecting with active equipment
- Backward compatible with Category 6, Category 5e, Category 5 and voice

6A



Category 6A Cassette to RJ45 Plug for 10G inter-connect with active hardware equipment

Product Description

The 6 port RapidNet Deca¹⁹ Cassette to RJ45 plug solution presents 6 RJ45 ports in one cassette with 4 cassettes fitting into the panel. A fully loaded panel presents 24 ports in 1U of space. The use of the full cross-connect solution reduces the risk of damage to the ports on expensive active equipment. When used for server connectivity it simplifies the management of connections to each unit without accessing the rear of the data cabinets.

Technical Data Table

Article-No.	Type	Performance Category	Height (H)	Width (W)	Depth (D)	Length (L)	Port count	Colour
859-36882	RN06G6A-CAPLXX-10.0M	Category 6A (Class EA)	31.0	107.0	130.0	10.0 m	6	Orange (OG)

All dimensions in mm. Subject to technical changes.

Technical Description

Designed as a cross-connect solution, each plug is individually terminated and tested to ensure the highest possible performance.

The RapidNet Cassette offers rear cable management and strain relief to all six cables to protect the cable and the terminations.

RapidNet terminations are tested to exceed all ISO/EIA 11801:2002 1.1 and ANSI/TIA/EIA 568 - C.2 Category 6A standards.

All RapidNet Category 6A cables are made with LSOH material, complying with the latest European fire ratings.

NB. Part Number is given for a 10m loom as an example. Lengths are available from 1m to 70m.

Technical Drawings

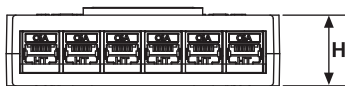

Front view of 6 port Category 6A Cassette

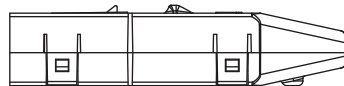

Side view of 6 port Category 6A Cassette

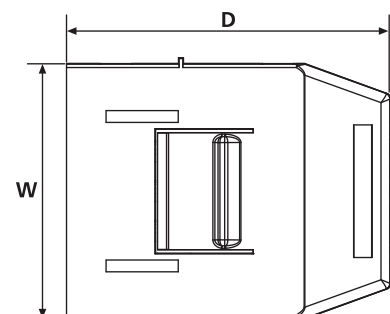

Top view of 6 port Category 6A Cassette



RapidNet Category 6A Cassette to Bare End

Features and Benefits

- Exceeds Category 6A performance standards
- Factory pre-terminated and tested
- Reduce installation times by up to 85%
- Ideal solution where lengths are unknown or access is limited
- Backward compatible with Category 6, Category 5e, Category 5 and voice



The Category 6A Cassette to Bare End solution offers flexibility during installation

Product Description

The Deca¹⁰ Cassette to Bare End is pre-terminated with 6 Deca¹⁰ Keystone Jacks earthed to a plate within the cassette. The earth plate in the cassette then makes contact with the earth points on the RapidNet Panel. The Deca¹⁰ Cassette is manufactured with a simple push clip mechanism and polarising pips to prevent incorrect insertion.

The Deca¹⁰ 6 port Cassette to Bare End option is specifically designed for projects where space between rooms is limited or lengths are uncertain at the planning stage. The bare end can then be terminated to specified outlets or panels making it an ideal solution for offices, call centres and data centres.

Technical Data Table

Article-No.	Type	Performance Category	Height (H)	Width (W)	Depth (D)	Length (L)	Port count	Colour
859-51097	RN06G6A-CABEXX-10.0M	Category 6A (Class EA)	31.0	107.0	130.0	10.0	6	Violet (VT)

All dimensions in mm. Subject to technical changes

Technical Description

The Deca¹⁰ Copper solution is designed using U-FTP Category 6A cable which provides 360° shielding and eliminates alien crosstalk.

The 6 port Deca¹⁰ Cassette presents 6 RJ45 ports in one cassette, with 4 cassettes fitting into the standard Deca¹⁰ Patch Panel. The cassettes simply push into the panel, snapping in with a releasable clip. A fully loaded panel presents the standard 24 ports in 1U of space.

The Deca¹⁰ Category 6A Cassette to Bare End with Category 6A Keystone Jack allowing 24 Category 6A connections in 1U. The integral earthing plate grounds each Keystone Jack helping to guarantee 10G performance by giving continuity of the 360° shielding.

All RapidNet Category 6A cables are made with LSOH material, complying with the latest European fire ratings.

NB. Part Number is given for a 10m loom as an example. Lengths are available from 5m to 90m.

Technical Drawings



Front view of 6 port Category 6A Cassette

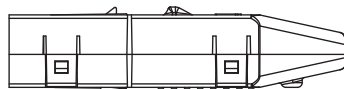

Side view of 6 port Category 6A Cassette

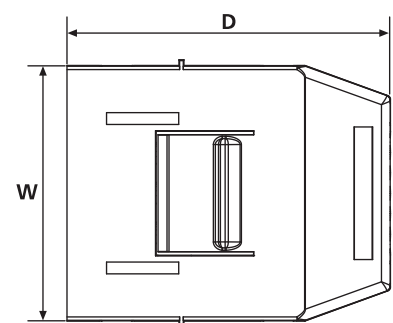

Top view of 6 port Category 6A Cassette



RapidNet 12 Port Category 6 Cassette to Cassette

Features and Benefits

- Exceeds Category 6 performance standards
- 12 port high density RapidNet Cassette
- Clear labelling presentation with magnifying lens
- Pre-tested with test results supplied
- Ideal 'cabinet to cabinet' solution
- Reduce installation time by up to 85%
- Backward compatible with Category 5e, Category 5 and voice

6



The 12 port RapidNet Cassette to Cassette offers 12 pre-terminated RJ45 Category 6 ports at each end

Product Description

The 12 port RapidNet Cassette to Cassette solution presents 12 RJ45 ports in one cassette with 4 cassettes fitting into the 12 port RapidNet Patch Panel. A fully loaded panel presents 48 ports in 1U of space.

The Cassette to Cassette option provides a high density cabinet to cabinet solution for the data centre or comms room.

Technical Data Table

Article-No.	Type	Performance Category	Height (H)	Width (W)	Depth (D)	Length (L)	Port count	Colour
859-06004	RN12UC6-CACAXX-10.0M	Category 6 (Class E)	41.0	103.0	133.0	10.0 m	12	Violet (VT)

All dimensions in mm. Subject to technical changes.

Technical Description

The RapidNet Cassette to Cassette option offers 48 RJ45 ports in 1U of space. Each cassette has its own magnified labelling field for effective port identification.

All RapidNet Category 6 cables are made with LSOH material, complying with the latest European fire ratings.

RapidNet terminations are tested to exceed all ISO/IEC 11801 and ANSI/TIA/EIA 568-C.2 Category 6 standards.

NB. Part Number is given for a 10m loom as an example. Lengths are available from 5m to 90m.

Technical Drawings

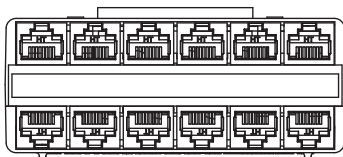

Front view of 12 port RapidNet Cassette

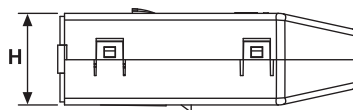

Side view of 12 port RapidNet Cassette

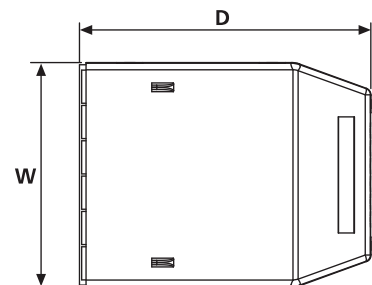

Top view of 12 port RapidNet Cassette



RapidNet 12 Port Category 6 Cassette to RJ45 Fan Out

Features and Benefits

- Exceeds Category 6 performance standards
- 12 port high density RapidNet Cassette
- Clear labelling presentation with magnifying lens
- Pre-tested with test results supplied
- RJ45 fan out plugs for managed patching
- Reduce installation time by up to 85%
- Backward compatible with Category 5e, Category 5 and voice

6



The Cassette to Plug option is designed as an inter-connect with active equipment

Product Description

The 12 port RapidNet Cassette to Cassette solution presents 12 RJ45 ports in one cassette with 4 cassettes fitting into the 12 port RapidNet Patch Panel. A fully loaded panel presents 48 ports in 1U of space.

The cassette to RJ45 Fan Out option provides a high density solution for connecting with active equipment in the comms room or data centre.

Technical Data Table

Article-No.	Type	Performance Category	Height (H)	Width (W)	Depth (D)	Length (L)	Port count	Colour
859-40325	RN12UC6-CAPLXX-10.0M	Category 6 (Class E)	41.0	103.0	133.0	10.0 m	12	Violet (VT)

All dimensions in mm. Subject to technical changes.

Technical Description

The RapidNet Cassette to Plug option offers 48 RJ45 ports in 1U of space. 12 RJ45 plugs are manufactured to a uniform length or a staggered length is available on request to allow effective cable management patching. Each cassette has its own magnified labelling field for effective port identification.

All RapidNet Category 6 cables are made with LSOH material, complying with the latest European fire ratings.

RapidNet terminations are tested to exceed all ISO/IEC 11801 and ANSI/TIA/EIA 568-C.2 Category 6 standards.

NB. Part Number is given for a 10m loom as an example. Lengths are available from 1m to 90m.

Technical Drawings

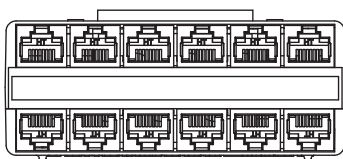

Front view of 12 port RapidNet Cassette

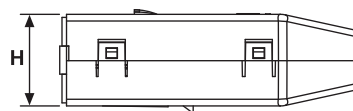

Side view of 12 port RapidNet Cassette

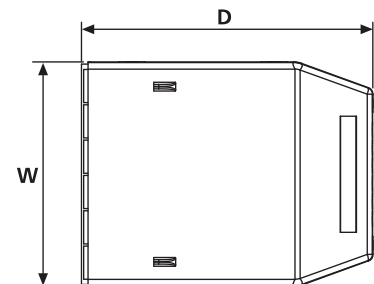

Top view of 12 port RapidNet Cassette



RapidNet 12 Port Category 6 Cassette to Split Cassette

Features and Benefits

- Exceeds Category 6 performance standards
- 12 port high density RapidNet Cassette
- Clear labelling presentation with magnifying lens
- Pre-tested with test results supplied
- Ideal 'cabinet to cabinet' solution
- Reduce installation time by up to 85%
- Backward compatible with Category 5e, Category 5 and voice

6



The split cassette option offers 2 separate 6 port cassettes which can be installed in a standard RapidNet Panel

Product Description

The 12 port RapidNet Cassette to Split Cassette solution allows flexibility within a data cabinet. At one end this option presents 12 RJ45 ports in one cassette with 4 cassettes fitting into the 12 port RapidNet Patch Panel giving 48 ports in 1U, while at the other end the two 6 cable bundles are pre-terminated into 2 individual 6 port cassettes giving 24 ports in 1U, where higher density is not required or diverse locations.

The Cassette to Cassette option provides a high density cabinet to cabinet solution for the data centre or comms room.

Technical Data Table

Article-No.	Type	Performance Category	Height (H)	Width (W)	Depth (D)	Length (L)	Port count	Colour
859-06005	RN12UC6-CASC02-10.0M	Category 6 (Class E)	41.0	103.0	133.0	10.0 m	12	Violet (VT)

All dimensions in mm. Subject to technical changes.

Technical Description

The RapidNet Cassette to Split Cassette option offers 48 RJ45 ports in 1U of space using the 12 port RapidNet Patch Panel. Each cassette has its own magnified labelling field for effective port identification. The 6 port cassette fits into the standard RapidNet Panel offering up to 24 RJ45 ports in 1U of space.

All RapidNet Category 6 cables are made with LSOH material, complying with the latest European fire ratings.

RapidNet terminations are tested to exceed all ISO/IEC 11801 and ANSI/TIA/EIA 568-C.2 Category 6 standards.

NB. Part Number is given for a 10m loom as an example. Lengths are available from 5m to 90m.

Technical Drawings

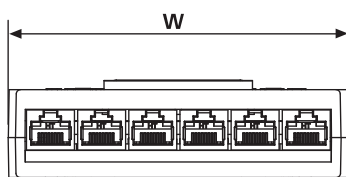

Front view of a 6 port RapidNet Cassette

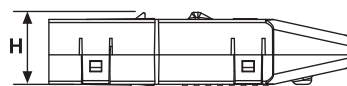

Side view of a 6 port RapidNet Cassette

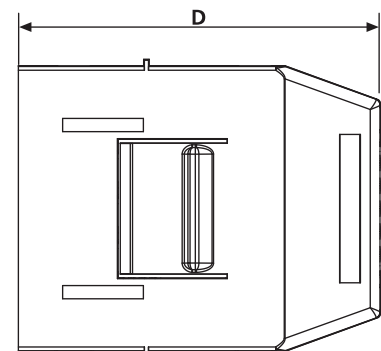

Top view of a 6 port RapidNet Cassette



RapidNet 12 Port Category 6 Cassette to Split Pod

Features and Benefits

- Exceeds Category 6 performance standards
- 12 port high density RapidNet Cassette
- Clear labelling presentation with magnifying lens
- Pre-tested with test results supplied
- Ideal 'to the desk' or work area solution
- Reduce installation time by up to 85%
- Backward compatible with Category 5e, Category 5 and voice

6



The RapidNet Pod fits into a range of floor boxes for work area networking

Product Description

The 12 port RapidNet Cassette to Split Pod solution allows flexibility to the work area. At one end this option presents 12 RJ45 ports in one cassette with 4 cassettes fitting into the 12 port RapidNet Patch Panel, while at the other end the two 6 cable bundles are pre-terminated into 2 individual 6 port pods. The pods are manufactured with 6 data outlets and provide an ideal 'to the desk' solution for offices, schools and call centres.

Technical Data Table

Article-No.	Type	Performance Category	Height (H)	Width (W)	Depth (D)	Length (L)	Port count	Colour
859-00352	RN12UC6-CASP02-10.0M	Category 6 (Class E)	59.0	61.0	184.0	10.0 m	12	Violet (VT)

All dimensions in mm. Subject to technical changes.

Technical Description

The RapidNet Cassette to Split Pod option offers 48 RJ45 ports in 1U of space. Each cassette has its own magnified labelling field for effective port identification.

The RapidNet Pod is manufactured with 6 shuttered RJ45 outlets and is compatible with most floor boxes.

All RapidNet Category 6 cables are made with LSOH material, complying with the latest European fire ratings.

RapidNet terminations are tested to exceed all ISO/IEC 11801 and ANSI/TIA/EIA 568-C.2 Category 6 standards.

NB. Part Number is given for a 10m loom as an example. Lengths are available from 5m to 90m.

Technical Drawings

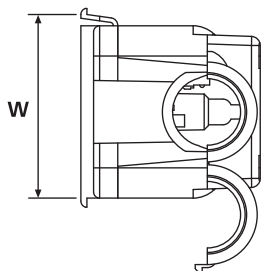

End view of RapidNet Pod showing the cable entry point

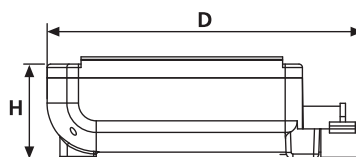

Side view of the RapidNet Pod

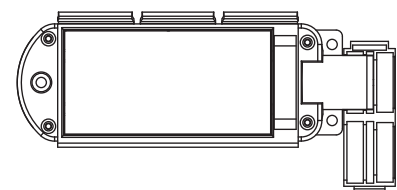

Top view of the RapidNet Pod showing cable entry clamp



RapidNet 12 Port Category 6 Cassette to Bare End

Features and Benefits

- Exceeds Category 6 performance standards
- 12 port high density RapidNet Cassette
- Clear labelling presentation with magnifying lens
- Pre-tested with test results supplied
- Reduce installation time by up to 85%
- Backward compatible with Category 5e, Category 5 and voice
- Ideal solution where lengths are unknown or access is limited

6



The Bare End option offers flexibility when apertures are small or lengths uncertain.

Product Description

The 12 port RapidNet Cassette is the high density solution in the world leading pre-terminated system range. Each cassette presents 12 RJ45 ports with a central labelling bar with magnifying lens for clear port identification. 4 cassettes fit into the 12 port RapidNet Panel giving up to 48 ports in 1U of rack space. The cassette is pre-terminated with 2 looms made of 6 cable bundles, providing several connectivity options at the 'other end'.

Technical Data Table

Article-No.	Type	Performance Category	Height (H)	Width (W)	Depth (D)	Length (L)	Port count	Colour
859-35578	RN12UC6-CABEXX-10.0M	Category 6 (Class E)	41.0	103.0	133.0	10.0 m	12	Violet (VT)

All dimensions in mm. Subject to technical changes.

Technical Description

The RapidNet Bare End option is designed to provide easier installation where access is limited or lengths are uncertain. The 12 bare ends can then be terminated to either a patch panel in the comms room or to outlets at the desk.

All RapidNet Category 6 cables are made with LSOH material, complying with the latest European fire ratings.

RapidNet terminations are tested to exceed all ISO/IEC 11801 and ANSI/TIA/EIA 568-C.2 Category 6 standards.

NB. Part Number is given for a 10m loom as an example. Lengths are available from 5m to 90m.

Technical Drawings

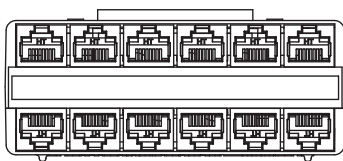

Front view of 12 port RapidNet Cassette

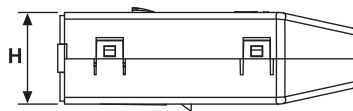

Side view of 12 port RapidNet Cassette

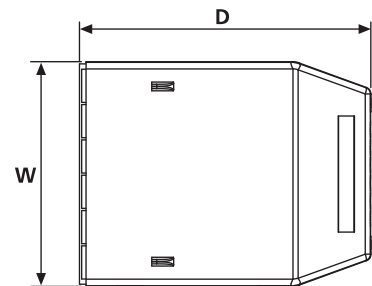

Top view of 12 port RapidNet Cassette



RapidNet 6 Port Category 6 Cassette to Cassette

Features and Benefits

- Exceeds Category 6 performance standards
- Factory pre-terminated and tested
- Reduce installation times by up to 85%
- Ideal solution for cabinet to cabinet installations
- Backward compatible with Category 5e, Category 5 and voice

6



The RapidNet Cassette to Cassette option is the ideal cabinet to cabinet solution

Product Description

The 6 port RapidNet Cassette to Cassette solution is specifically designed for inter-cabinet installations that are common place in today's data centre.

The 6 port RapidNet Cassette provides 24 pre-terminated, pre-tested ports in 1U.

Technical Data Table

Article-No.	Type	Performance Category	Height (H)	Width (W)	Depth (D)	Length (L)	Port count	Colour
859-05628	RN06UC6-CACAXX-10.0M	Category 6 (Class E)	31.0	107.0	130.0	10.0 m	6	Violet (VT)

All dimensions in mm. Subject to technical changes.

Technical Description

The 6 port RapidNet Cassette presents 6 RJ45 ports in one cassette, with 4 cassettes fitting into the standard RapidNet Patch Panel giving 24 ports in 1U. The cassettes simply snap into the panel, with a push down clip. A fully loaded panel presents the standard 24 ports in 1U of space.

Rear cable management is provided within the cassette with a strain relief bar holding all 6 cables in place protecting the cable and its terminations.

All RapidNet Category 6 cables are made with LSOH material, complying with the latest European fire ratings.

RapidNet terminations are tested to exceed all ISO/IEC 11801 and ANSI/TIA/EIA 568-C.2 Category 6 standards.

NB. Part Number is given for a 10m loom as an example. Lengths are available from 5m to 90m.

Technical Drawings

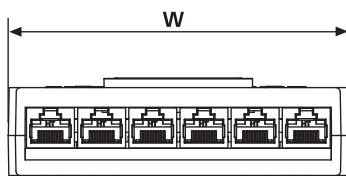

Front view of a 6 port RapidNet Cassette



Side view of a 6 port RapidNet Cassette

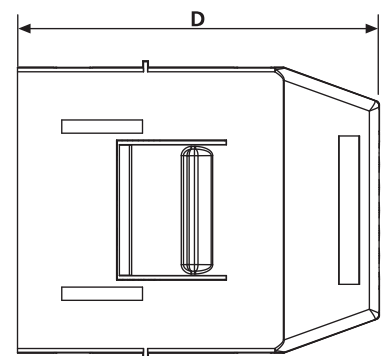

Top view of a 6 port RapidNet Cassette



RapidNet 6 Port Category 6 Cassette to Keystone Jack

Features and Benefits

- Exceeds Category 6 performance standards
- Factory pre-terminated and tested
- Ideal solution for 'to the desk' installations
- Compatible with Alpha Snap and 6C Modules
- Can fit in both floor boxes and wall boxes

6

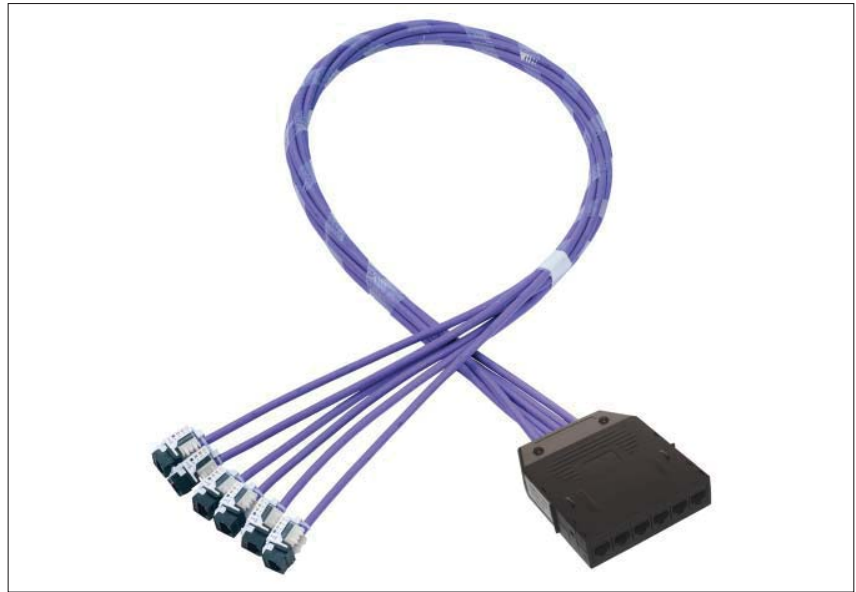

Keystone Jack option allows floor box and face plate connectivity in the work place

Product Description

The 6 port RapidNet Cassette to Keystone Jack option gives installers and end users added flexibility at the desk or 'work area' end.

The Keystone Jack can be easily clipped into a selection of modules that can be fitted in to floor boxes or wall mounted in face plates.

Technical Data Table

Article-No.	Type	Performance Category	Height (H)	Width (W)	Depth (D)	Length (L)	Port count	Colour
859-35448	RN06UC6-CAKJXX-10.0M	Category 6 (Class E)	31.0	107.0	130.0	10.0 m	6	Violet (VT)

All dimensions in mm. Subject to technical changes.

Technical Description

The RapidNet Cassette to Keystone Jack is designed to support 'to the desk' installations, with the Keystone Jack fitting into either a floor box or wall box using HellermannTyton's range of modules and face plates.

The Keystone Jacks are available in a range of colours and can be packaged with a heat-shrink pulling sock to protect the jacks during installation.

The Keystone Jacks can also be terminated at staggered lengths to allow connectivity at individual locations within a work area.

All RapidNet Category 6 cables are made with LSOH material, complying with the latest European fire ratings.

RapidNet terminations are tested to exceed all ISO/IEC 11801 and ANSI/TIA/EIA 568-C.2 Category 6 standard.

NB. Part Number is given for a 10m loom as an example. Lengths are available from 5m to 90m.

Technical Drawings

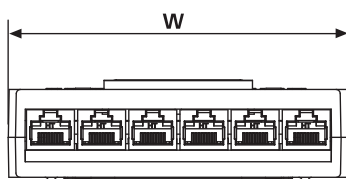

Front view of a 6 port RapidNet Cassette



Side view of a 6 port RapidNet Cassette

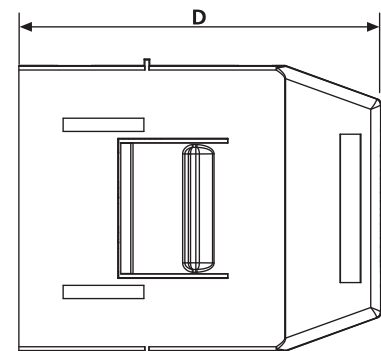

Top view of a 6 port RapidNet Cassette



RapidNet 6 Port Category 6 Cassette to RJ45 Plug

Features and Benefits

- Exceeds Category 6 performance standards
- Factory pre-terminated and tested
- Reduce installation times by up to 85%
- Ideal solution when connecting with active equipment
- Backward compatible with Category 5e, Category 5 and voice

6



The cassette to RJ45 Plug solution is an ideal inter-connect for active hardware equipment

Product Description

The 6 port RapidNet Cassette to RJ45 Plug solution presents 6 RJ45 ports in one cassette with 4 cassettes fitting into the panel. A fully loaded panel presents 24 ports in 1U of space. The use of the full cross-connect solution reduces the risk of damage to the ports on expensive active equipment. When used for server connectivity it simplifies the management of connections to each unit without accessing the rear of the data cabinets.

Technical Data Table

Article-No.	Type	Performance Category	Height (H)	Width (W)	Depth (D)	Length (L)	Port count	Colour
859-40307	RN06UC6-CAPLXX-10.0M	Category 6 (Class E)	31.0	107.0	130.0	10.0 m	6	Violet (VT)

All dimensions in mm. Subject to technical changes.

Technical Description

Designed as a cross-connect solution, each plug is individually terminated and tested to ensure the highest possible performance.

The RapidNet Cassette offers rear cable management and strain relief to all six cables to protect the cable and the terminations.

RapidNet terminations are tested to exceed all ISO/IEC 11801 and ANSI/TIA/EIA 568-C.2 Category 6 standards.

All RapidNet Category 6 cables are made with LSOH material, complying with the latest European fire ratings.

NB. Part Number is given for a 10m loom as an example. Lengths are available from 1m to 90m.

Technical Drawings

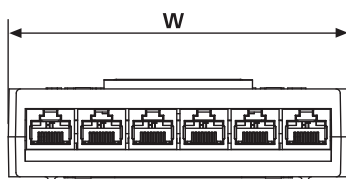

Front view of a 6 port RapidNet Cassette



Side view of a 6 port RapidNet Cassette

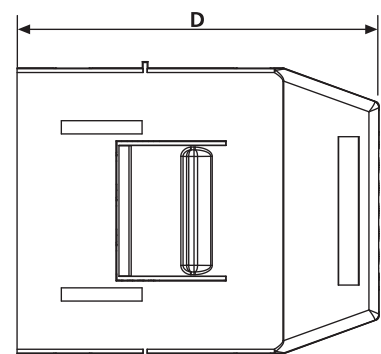

Top view of a 6 port RapidNet Cassette



RapidNet 6 Port Category 6

Cassette to Pod

Features and Benefits

- Exceeds Category 6 performance standards
- Factory pre-terminated and tested
- Can be used as a 'to the desk' installation
- Provides 6 high density GigaBand Outlets per pod
- Fits into standard floor boxes

6



The RapidNet Pod can be fixed into a range of floor boxes for work area solutions.

Product Description

The Cassette to Pod option is designed to support any 'to the desk' installation in various commercial environments including offices, trading floors and schools.

The pod can be mounted to the desk, snapped directly into a floor box aperture or used beneath a raised floor or in the ceiling void as a consolidation point.

The 6 port RapidNet Pod is manufactured with six Category 6 high density GigaBand outlets.

Technical Data Table

Article-No.	Type	Performance Category	Height (H)	Width (W)	Depth (D)	Length (L)	Port count	Colour
859-00260	RN06UC6-CAPOXX-10M	Category 6 (Class E)	59.0	61.0	184.0	10.0 m	6	Violet (VT)

All dimensions in mm. Subject to technical changes.

Technical Description

The RapidNet Pod is designed to clip into standard floor boxes via a suitable floor box mounting plate. The rounded edges alleviate snagging during the pulling and fixing stages of an installation. For protection during delivery, the pod is inserted within the cable reel and up to 5 metres of the cable can be protected by a black copex sleeve (on request).

During installation the pod can be slipped off the reel ready to be pulled into position.

All RapidNet Category 6 cables are made with LSOH material, complying with the latest European fire ratings.

RapidNet terminations are tested to exceed all ISO/IEC 11801 and ANSI/TIA/EIA 568-C.2 Category 6 standards.

NB. Part Number is given for a 10m loom as an example. Lengths are available from 5m to 90m.

Technical Drawings

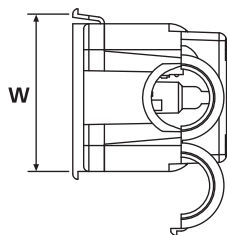

End view of RapidNet Pod showing the cable entry point

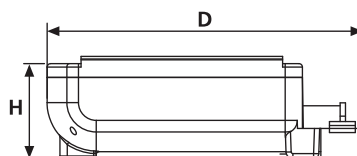

Side view of the RapidNet Pod

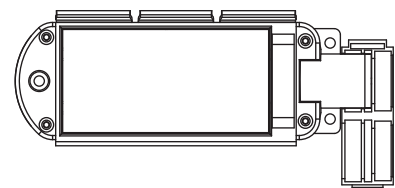

Top view of the RapidNet Pod showing cable entry clamp



RapidNet 6 Port Category 6 Cassette to Bare End

Features and Benefits

- Exceeds Category 6 performance standards
- Factory pre-terminated and tested
- Reduce installation times by up to 85%
- Ideal solution where space is limited
- Backward compatible with Category 5e, Category 5 and voice

6



RapidNet Cassette to Bare End offers flexibility during installation

Product Description

The 6 port Cassette to Bare End RapidNet option is specifically designed for projects where space between rooms is limited or lengths are uncertain at the planning stage. The bare end can then be terminated to specified outlets or panels making it an ideal solution for offices, call centres and data centres.

Technical Data Table

Article-No.	Type	Performance Category	Height (H)	Width (W)	Depth (D)	Length (L)	Port count	Colour
859-10291	RN06UC6-CABEXX-10.0M	Category 6 (Class E)	31.0	107.0	130.0	10.0 m	6	Violet (VT)

All dimensions in mm. Subject to technical changes.

Technical Description

The 6 port RapidNet Cassette presents 6 RJ45 ports in one cassette, with 4 cassettes fitting into the standard RapidNet Patch Panel giving 24 ports in 1U of rack space.

The RapidNet Cassette offers rear cable management and strain relief to all six cables to protect the cable and the terminations.

All RapidNet Category 6 cables are made with LSOH material, complying with the latest European fire ratings.

RapidNet terminations are tested to exceed all ISO/IEC 11801 and ANSI/TIA/EIA 568-C.2 Category 6 standards.

NB. Part Number is given for a 10m loom as an example. Lengths are available from 5m to 90m.

Technical Drawings

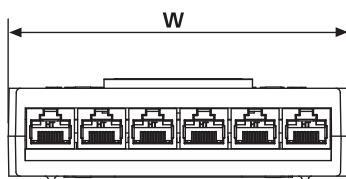

Front view of a 6 port RapidNet Cassette



Side view of a 6 port RapidNet Cassette

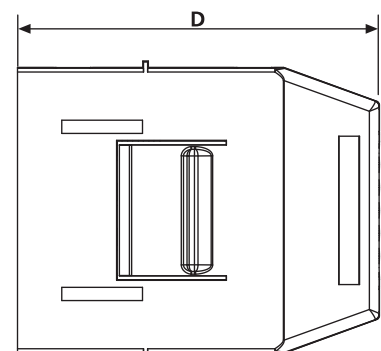

Top view of a 6 port RapidNet C cassette



RapidNet 4 Port Category 6 Cassette to Cassette

Features and Benefits

- Exceeds Category 6 performance standards
- Factory pre-terminated and tested
- Reduce installation times by up to 85%
- Ideal solution for cabinet to cabinet installations
- Backward compatible with Category 5e, Category 5 and voice

6



The 4 port Cassette to Cassette option is designed for inter-cabinet links where limited ports are required

Product Description

The Cassette to Cassette option is specifically designed for inter-cabinet installations that are common place in today's data centre.

The 4 port RapidNet solution also lends itself to the office and call centre environment with the 4 ports delivering voice and data to 2 desks per loom.

Technical Data Table

Article-No.	Type	Performance Category	Height (H)	Width (W)	Depth (D)	Length (L)	Port count	Colour
859-05415	RN04UC6-CACAXX-10.0M	Category 6 (Class E)	28.0	70.0	116.0	10.0 m	4	Violet (VT)

All dimensions in mm. Subject to technical changes.

Technical Description

The 4 port RapidNet Cassette presents 4 RJ45 ports in one cassette, with 6 cassettes fitting into the standard 4 port RapidNet Patch Panel. The cassettes simply snap into the panel, with a push down clip. A fully loaded panel presents the standard 24 ports in 1U of space.

Rear cable management is provided within the cassette with a strain relief bar holding all 4 cables in place protecting the cable and its terminations.

All RapidNet Category 6 cables are made with LSOH material, complying with the latest European fire ratings.

RapidNet terminations are tested to exceed all ISO/IEC 11801 and ANSI/TIA/EIA 568-C.2 Category 6 standards.

NB. Part Number is given for a 10m loom as an example. Lengths are available from 5m to 90m.

Technical Drawings

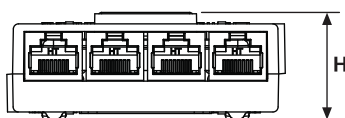

Front view of 4 port RapidNet Cassette

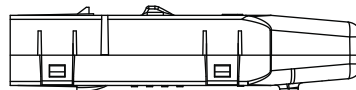

Side view of 4 port RapidNet Cassette

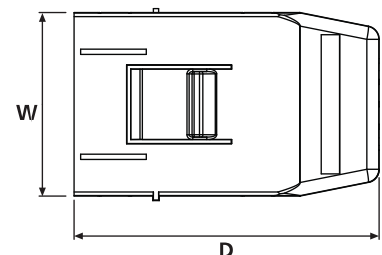

Top view of 4 port RapidNet Cassette



RapidNet 4 Port Category 6 Cassette to Keystone Jack

Features and Benefits

- Exceeds Category 6 performance standards
- Factory pre-terminated and tested
- Ideal solution for 'to the desk' installations
- Compatible with Alpha Snap and 6C Modules
- Can fit in both floor boxes and wall boxes

6



Designed for the work area, the Keystone Jacks fit into floor boxes using HellermannTyton angled adapters

Product Description

The 4 port RapidNet Cassette to Keystone Jack option gives installers and end users added flexibility at the desk or 'work area' end.

The Keystone Jack can be easily clipped into a selection of modules that can be fitted in to floor boxes or wall mounted in face plates.

Technical Data Table

Article-No.	Type	Performance Category	Height (H)	Width (W)	Depth (D)	Length (L)	Port count	Colour
859-35950	RN04UC6-CAKJXX-10.0M	Category 6 (Class E)	28.0	70.0	116.0	10.0 m	4	Violet (VT)

All dimensions in mm. Subject to technical changes.

Technical Description

The RapidNet Cassette to Keystone Jack is designed to support 'to the desk' installations, with the Keystone Jack fitting into either a floor box or wall box using HellermannTyton's range of modules and face plates.

The Keystone Jacks are available in a range of colours and can be packaged with a heat-shrink pulling sock to protect the jacks during installation.

The Keystone Jacks can also be terminated at staggered lengths to allow connectivity at individual locations within a work area.

All RapidNet Category 6 cables are made with LSOH material, complying with the latest European fire ratings.

RapidNet terminations are tested to exceed all ISO/IEC 11801 and ANSI/TIA/EIA 568-C.2 Category 6 standard.

NB. Part Number is given for a 10m loom as an example. Lengths are available from 5m to 90m.

Technical Drawings

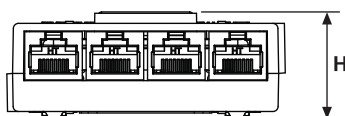

Front view of 4 port RapidNet Cassette

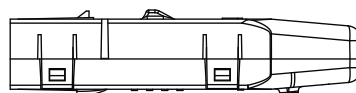

Side view of 4 port RapidNet Cassette

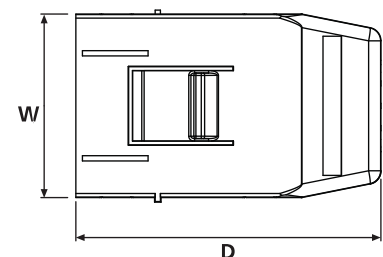

Top view of 4 port RapidNet Cassette



RapidNet 4 Port Category 6

Cassette to RJ45 Plug

Features and Benefits

- Exceeds Category 6 performance standards
- Factory pre-terminated and tested
- Reduce installation times by up to 85%
- Ideal solution when connecting with active equipment
- Backward compatible with Category 5e, Category 5 and voice

6



Cassette to plug can be used as an inter-connect with active hardware

Product Description

The RapidNet Cassette to Plug option has been specially designed for cabinet to active equipment installations.

The use of the full cross-connect solution reduces the risk of damage to the ports on expensive active equipment. When used for server connectivity it simplifies the management of connections to each unit without accessing the rear of the data cabinets.

Technical Data Table

Article-No.	Type	Performance Category	Height (H)	Width (W)	Depth (D)	Length (L)	Port count	Colour
859-40084	RN04UC6-CAPLXX-10.0M	Category 6 (Class E)	28.0	70.0	116.0	10.0 m	4	Violet (VT)

All dimensions in mm. Subject to technical changes.

Technical Description

Designed as a cross-connect solution, each plug is individually terminated and tested to ensure the highest possible performance.

The RapidNet Cassette offers rear cable management and strain relief to all four cables to protect the cable and the terminations.

RapidNet terminations are tested to exceed all ISO/IEC 11801 and ANSI/TIA/EIA 568-C.2 Category 6 standards.

All RapidNet Category 6 cables are made with LSOH material, complying with the latest European fire ratings.

NB. Part Number is given for a 10m loom as an example. Lengths are available from 1m to 90m.

Technical Drawings

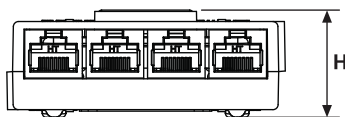

Front view of 4 port RapidNet Cassette

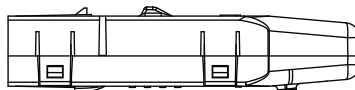

Side view of 4 port RapidNet Cassette

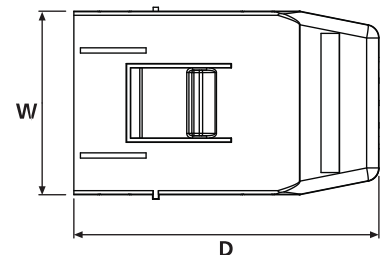

Top view of 4 port RapidNet Cassette



RapidNet 4 Port Category 6 Cassette to Pod

Features and Benefits

- Exceeds Category 6 performance standards
- Factory pre-terminated and tested
- Can be used as a 'to the desk' installation
- Provides 4 GigaBand Outlets per pod
- Fits into standard floor boxes

6



The RapidNet Pod fits into a wide range of floor boxes for work area solutions

Product Description

The Cassette to Pod option is designed to support any to the desk installation in various commercial environments including offices, trading floors and schools.

The pod can be mounted to the desk, snapped directly into a floor box aperture or used beneath a raised floor or in the ceiling void as a consolidation point.

The 4 port RapidNet Pod is manufactured with four Category 6 GigaBand Outlets.

Technical Data Table

Article-No.	Type	Performance Category	Height (H)	Width (W)	Depth (D)	Length (L)	Port count	Colour
859-35339	RN04UC6-CAPOXX-10.0M	Category 6 (Class E)	59.0	61.0	184.0	10.0 m	4	Violet (VT)

All dimensions in mm. Subject to technical changes.

Technical Description

The RapidNet Pod can also be used as a consolidation point under the floor or within a ceiling void, adding more flexibility to any network infrastructure.

The pod is designed to clip into standard floor boxes via a suitable floor box mounting plate. The rounded edges alleviate snagging during the pulling and fixing stages of an installation. For protection during delivery, the pod is inserted within the cable reel and up to 5 metres of the cable can be protected by a black copex sleeve (on request).

During installation the pod can be slipped off the reel ready to be pulled into position.

All RapidNet Category 6 cables are made with LSOH material, complying with the latest European fire ratings.

RapidNet terminations are tested to exceed all ISO/IEC 11801 and ANSI/TIA/EIA 568-C.2 Category 6 standards.

NB. Part Number is given for a 10m loom as an example. Lengths are available from 5m to 90m.

Technical Drawings

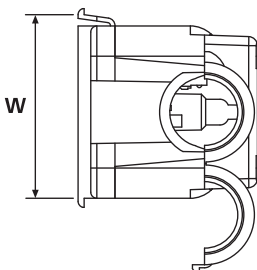

End view of RapidNet Pod showing cable entry point

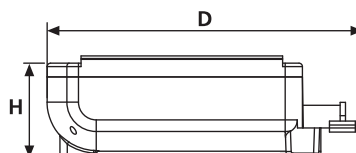

Side view of RapidNet Pod

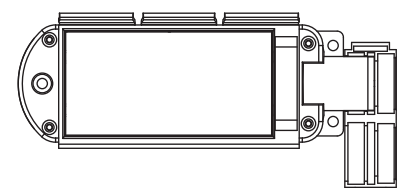

Top view of RapidNet Pod showing cable entry clamp



RapidNet 4 Port Category 6 Cassette to Bare End

Features and Benefits

- Exceeds Category 6 performance standards
- Factory pre-terminated and tested
- Reduce installation times by up to 85%
- Ideal solution where space is limited
- Backward compatible with Category 5e, Category 5 and voice

6



The 4 port Bare End option offers flexibility during installation

Product Description

The 4 port Cassette to Bare End RapidNet option is specifically designed for projects where space between rooms is limited or lengths are uncertain at the planning stage. The bare end can then be terminated to specified outlets or panels making it an ideal solution for offices, call centres and data centres.

Technical Data Table

Article-No.	Type	Performance Category	Height (H)	Width (W)	Depth (D)	Length (L)	Port count	Colour
859-10285	RN04UC6-CABEXX-10.0M	Category 6 (Class E)	28.0	70.0	116.0	10.0 m	4	Violet (VT)

All dimensions in mm. Subject to technical changes.

Technical Description

The RapidNet Bare End option is designed to provide easier access with limited space or apertures between rooms. The 4 bare ends can then be terminated to either a patch panel in the comms room or to outlets at the desk.

All RapidNet Category 6 cables are made with LSOH material, complying with the latest European fire ratings.

RapidNet terminations are tested to exceed all ISO/IEC 11801 and ANSI/TIA/EIA 568-C.2 Category 6 standards.

NB. Part Number is given for a 10m loom as an example. Lengths are available from 5m to 90m.

Technical Drawings

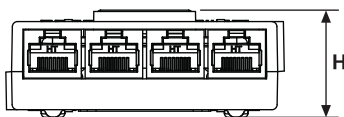

Front view of 4 port RapidNet Cassette

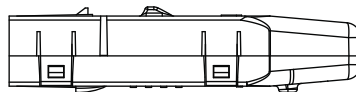

Side view of 4 port RapidNet Cassette

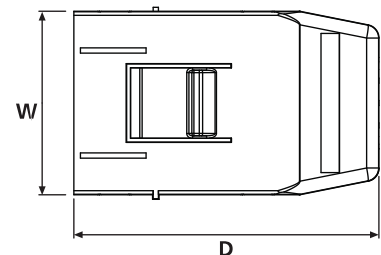

Top view of 4 port RapidNet Cassette



RapidNet 6 Port Category 5e Cassette to Cassette

Features and Benefits

- Exceeds Category 5e performance standards
- Factory pre-terminated and tested
- Reduce installation times by up to 85%
- Ideal solution for cabinet to cabinet installations
- Backward compatible with Category 5 and voice



The RapidNet Cassette to Cassette option is ideal cabinet to cabinet solution

Product Description

The 6 port RapidNet Cassette to Cassette solution is specifically designed for inter-cabinet installations that are common place in today's data centre.

The 6 port RapidNet Cassette provides 24 pre-terminated, pre-tested ports in 1U.

Technical Data Table

Article-No.	Type	Performance Category	Height (H)	Width (W)	Depth (D)	Length (L)	Port count	Colour
859-05490	RN06U5E-CACAXX-10.0M	Category 5E (Class D)	31.0	107.0	130.0	10.0 m	6	Violet (VT)

All dimensions in mm. Subject to technical changes.

Technical Description

The 6 port RapidNet Cassette presents 6 RJ45 ports in one cassette, with 4 cassettes fitting into the standard RapidNet Patch Panel. The cassettes simply snap into the panel, with a push down clip. A fully loaded panel presents the standard 24 ports in 1U of space.

Rear cable management is provided within the cassette with a strain relief bar holding all 6 cables in place protecting the cable and its terminations.

All RapidNet Category 5e cables are made with LSOH material, complying with the latest European fire ratings.

RapidNet terminations are tested to exceed all ISO/IEC 11801 and ANSI/TIA/EIA 568-C.2 Category 5e standards.

NB. Part Number is given for a 10m loom as an example. Lengths are available from 5m to 90m.

Technical Drawings

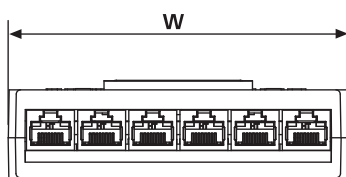

Front view of a 6 port RapidNet Cassette



Side view of a 6 port RapidNet Cassette

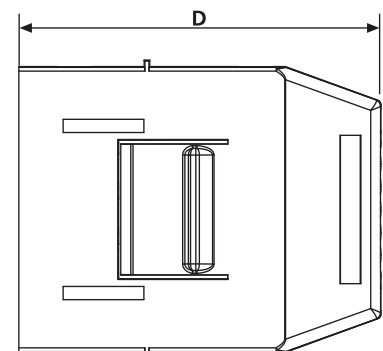

Top view of a 6 port RapidNet Cassette



RapidNet 6 Port Category 5e Cassette to Keystone Jack

Features and Benefits

- Exceeds Category 5e performance standards
- Factory pre-terminated and tested
- Ideal solution for 'to the desk' installations
- Compatible with Alpha Snap and 6C Modules
- Can fit in both floor boxes and wall boxes

5e

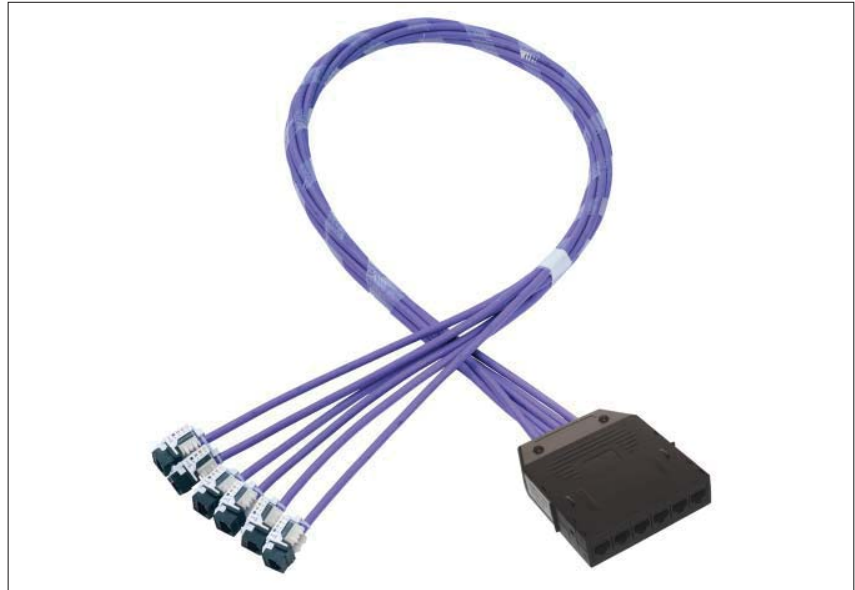

Keystone Jack option allows floor box and face plate connectivity in the work place

Product Description

The 6 port RapidNet Cassette to Keystone Jack option gives installers and end users added flexibility at the desk or 'work area' end.

The Keystone Jack can be easily clipped into a selection of modules that can be fitted in to floor boxes or wall mounted in face plates.

Technical Data Table

Article-No.	Type	Performance Category	Height (H)	Width (W)	Depth (D)	Length (L)	Port count	Colour
859-35546	RN06U5E-CAKJXX-10.0M	Category 5E (Class D)	31.0	107.0	130.0	10.0 m	6	Violet (VT)

All dimensions in mm. Subject to technical changes.

Technical Description

The RapidNet Cassette to Keystone Jack is designed to support 'to the desk' installations, with the Keystone Jack fitting into either a floor box or wall box using HellermannTyton's range of modules and face plates.

The Keystone Jacks are available in a range of colours and can be packaged with a heat-shrink pulling sock to protect the jacks during installation.

The Keystone Jacks can also be terminated at staggered lengths to allow connectivity at individual locations within a work area.

All RapidNet Category 5e cables are made with LSOH material, complying with the latest European fire ratings.

RapidNet terminations are tested to exceed all ISO/IEC 11801 and ANSI/TIA/EIA 568-C.2 Category 5e standard.

NB. Part Number is given for a 10m loom as an example. Lengths are available from 5m to 90m.

Technical Drawings

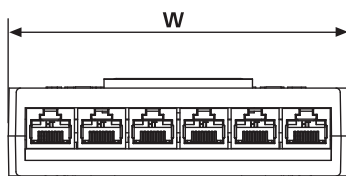

Front view of a 6 port RapidNet Cassette



Side view of a 6 port RapidNet Cassette

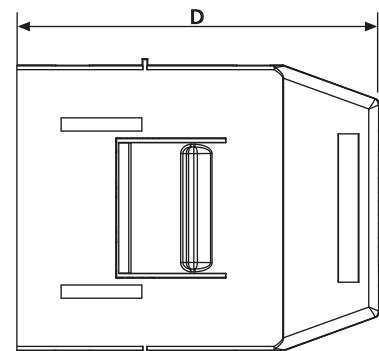

Top view of a 6 port RapidNet Cassette



RapidNet 6 Port Category 5e Cassette to RJ45 Plug

Features and Benefits

- Exceeds Category 5e performance standards
- Factory pre-terminated and tested
- Reduce installation times by up to 85%
- Ideal solution when connecting with active equipment
- Backward compatible with Category 5 and voice



The cassette to RJ45 plug solution is an ideal inter-connect for active hardware equipment

Product Description

The RapidNet Cassette to Plug option has been specially designed for cabinet to active equipment installations.

The use of the full cross-connect solution reduces the risk of damage to the ports on expensive active equipment.

When used for server connectivity it simplifies the management of connections to each unit without accessing the rear of the data cabinets.

Technical Data Table

Article-No.	Type	Performance Category	Height (H)	Width (W)	Depth (D)	Length (L)	Port count	Colour
859-40137	RN06U5E-CAPLXX-10.0M	Category 5E (Class D)	31.0	107.0	130.0	10.0 m	6	Violet (VT)

All dimensions in mm. Subject to technical changes.

Technical Description

Designed as a cross-connect solution, each plug is individually terminated and tested to ensure the highest possible performance.

The RapidNet Cassette offers rear cable management and strain relief to all four cables to protect the cable and the terminations.

RapidNet terminations are tested to exceed all ISO/IEC 11801 and ANSI/TIA/EIA 568-C.2 Category 5e standards.

All RapidNet Category 5e cables are made with LS0H material, complying with the latest European fire ratings.

NB. Part Number is given for a 10m loom as an example. Lengths are available from 1m to 90m.

Technical Drawings

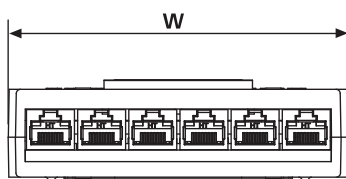

Front view of a 6 port RapidNet Cassette

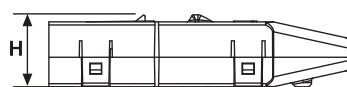

Side view of a 6 port RapidNet Cassette

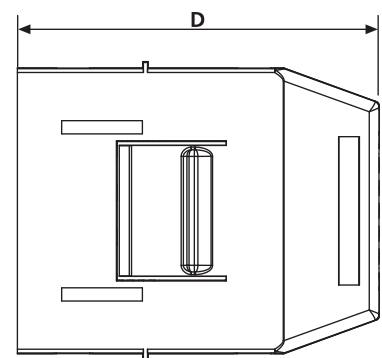

Top view of a 6 port RapidNet Cassette



RapidNet 6 Port Category 5e Cassette to Pod

Features and Benefits

- Exceeds Category 5e performance standards
- Factory pre-terminated and tested
- Can be used as a 'to the desk' installation
- Provides 6 high density Alpha Snap Outlets per pod
- Fits into standard floor boxes



The RapidNet Pod can be fixed into a range of floor boxes for work area solutions

Product Description

The Cassette to Pod option is designed to support any 'to the desk' installation in various commercial environments including offices, trading floors and schools.

The pod can be mounted to the desk, snapped directly into a floor box aperture or used beneath a raised floor or in the ceiling void as a consolidation point.

The 6 port RapidNet Pod is manufactured with six Category 5e high density Alpha Snap Outlets.

Technical Data Table

Article-No.	Type	Performance Category	Height (H)	Width (W)	Depth (D)	Length (L)	Port count	Colour
859-00199	RN06U5E-CAPOXX-10.0M	Category 5E (Class D)	59.0	61.0	184.0	10.0 m	6	Violet (VT)

All dimensions in mm. Subject to technical changes.

Technical Description

The RapidNet Pod can also be used as a consolidation point under the floor or within a ceiling void, adding more flexibility to any network infrastructure.

The pod is designed to clip into standard floor boxes via a suitable floor box mounting plate. The rounded edges alleviate snagging during the pulling and fixing stages of an installation. For protection during delivery, the pod is inserted within the cable reel and up to 5 metres of the cable can be protected by a black copex sleeve (on request).

During installation the pod can be slipped off the reel ready to be pulled into position.

All RapidNet Category 5e cables are made with LSOH material, complying with the latest European fire ratings.

RapidNet terminations are tested to exceed all ISO/IEC 11801 and ANSI/TIA/EIA 568-C.2 Category 5e standards.

NB. Part Number is given for a 10m loom as an example. Lengths are available from 5m to 90m.

Technical Drawings

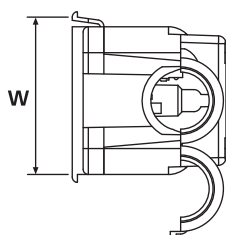

End view of RapidNet Pod showing the cable entry point

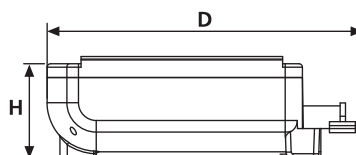

Side view of the RapidNet Pod

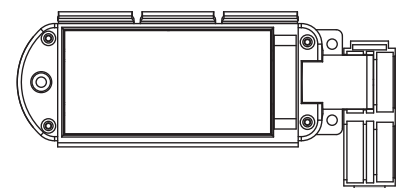

Top view of the RapidNet Pod showing cable entry clamp



RapidNet 6 Port Category 5e Cassette to Bare End

Features and Benefits

- Exceeds Category 5e performance standards
- Factory pre-terminated and tested
- Reduce installation times by up to 85%
- Ideal solution where space is limited
- Backward compatible with Category 5 and voice



The RapidNet to Bare End offers flexibility during installation

Product Description

The 6 port Cassette to Bare End RapidNet option is specifically designed for projects where space between rooms is limited or lengths are uncertain at the planning stage. The bare end can then be terminated to specified outlets or panels making it an ideal solution for offices, call centres and data centres.

Technical Data Table

Article-No.	Type	Performance Category	Height (H)	Width (W)	Depth (D)	Length (L)	Port count	Colour
859-10330	RN06U5E-CABEXX-10.0M	Category 5E (Class D)	31.0	107.0	130.0	10.0 m	6	Violet (VT)

All dimensions in mm. Subject to technical changes.

Technical Description

The RapidNet Bare End option is designed to provide easier access with limited space or apertures between rooms. The 6 bare ends can then be terminated to either a patch panel in the comms room or to outlets at the desk.

All RapidNet Category 5e cables are made with LS0H material, complying with the latest European fire ratings.

RapidNet terminations are tested to exceed all ISO/IEC 11801 and ANSI/TIA/EIA 568-C.2 Category 5e standards.

NB. Part Number is given for a 10m loom as an example. Lengths are available from 5m to 90m.

Technical Drawings

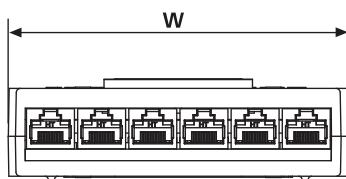

Front view of a 6 port RapidNet Cassette



Side view of a 6 port RapidNet Cassette

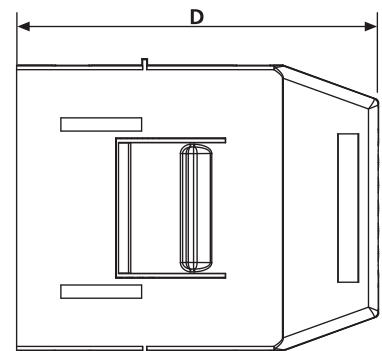

Top view of a 6 port RapidNet Cassette



RapidNet 4 Port Category 5e Cassette to Cassette

Features and Benefits

- Exceeds Category 5e performance standards
- Factory pre-terminated and tested
- Reduce installation times by up to 85%
- Ideal solution for cabinet to cabinet installations
- Backward compatible with Category 5 and voice

5e



Category 5e RapidNet 4 port Cassette to Cassette

Product Description

The Cassette to Cassette option is specifically designed for inter-cabinet installations that are common place in todays data centre where frequent adds and changes are common place.

The 4 port RapidNet solution also lends itself to the office and call centre environment with the 4 ports delivering voice and data to 2 desks per loom.

Technical Data Table

Article-No.	Type	Performance Category	Height (H)	Width (W)	Depth (D)	Length (L)	Port count	Colour
859-05417	RN04U5E-CACAXX-10.0M	Category 5E (Class D)	28.0	70.0	116.0	10.0 m	4	Violet (VT)

All dimensions in mm. Subject to technical changes.

Technical Description

The 4 port RapidNet Cassette presents 4 RJ45 ports in one cassette, with 6 cassettes fitting into the standard 4 port RapidNet Patch Panel. The cassettes simply snap into the panel, with a push down clip. A fully loaded panel presents the standard 24 ports in 1U of space.

Rear cable management is provided within the cassette with a strain relief bar holding all 4 cables in place protecting the cable and its terminations.

All RapidNet Category 5e cables are made with LSOH material, complying with the latest European fire ratings.

RapidNet terminations are tested to exceed all ISO/IEC 11801 and ANSI/TIA/EIA 568-C.2 Category 5e standards.

NB. Part Number is given for a 10m loom as an example. Lengths are available from 5m to 90m.

Technical Drawings

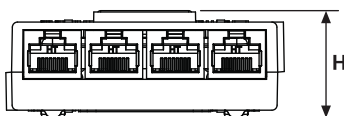

Front view of 4 port RapidNet Cassette

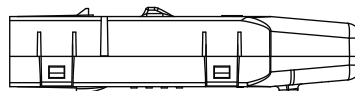

Side view of 4 port RapidNet Cassette

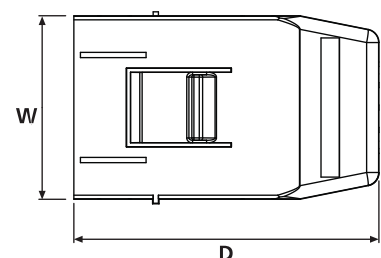

Top view of 4 port RapidNet Cassette



RapidNet 4 Port Category 5e Cassette to Keystone Jack

Features and Benefits

- Exceeds Category 5e performance standards
- Factory pre-terminated and tested
- Ideal solution for 'to the desk' installations
- Compatible with Alpha Snap and 6C Modules
- Can fit in both floor boxes and wall boxes



Designed for the work area, the Keystone Jacks fit into floor boxes using HellermannTyton angled adapters

Product Description

The 4 port RapidNet Cassette to Keystone Jack option gives installers and end users added flexibility at the desk or 'work area' end. The Keystone Jack can be easily clipped into a selection of modules that can be fitted in to floor boxes or wall mounted in face plates.

Technical Data Table

Article-No.	Type	Performance Category	Height (H)	Width (W)	Depth (D)	Length (L)	Port count	Colour
859-37952	RN04U5E-CAKJXX-10.0M	Category 5E (Class D)	28.0	70.0	116.0	10.0 m	4	Violet (VT)

All dimensions in mm. Subject to technical changes.

Technical Description

The RapidNet Cassette to Keystone Jack is designed to support 'to the desk' installations, with the Keystone Jack fitting into either a floor box or wall box using HellermannTyton's range of modules and face plates.

The Keystone Jacks are available in a range of colours and can be packaged with a heat-shrink pulling sock to protect the jacks during installation.

The Keystone Jacks can also be terminated at staggered lengths to allow connectivity at individual locations within a work area.

All RapidNet Category 5e cables are made with LSOH material, complying with the latest European fire ratings.

RapidNet terminations are tested to exceed all ISO/IEC 11801 and ANSI/TIA/EIA 568-C.2 Category 5e standard.

NB. Part Number is given for a 10m loom as an example. Lengths are available from 5m to 90m.

Technical Drawings

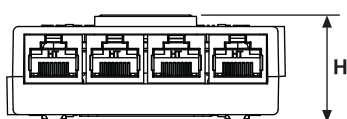

Front view of 4 port RapidNet Cassette

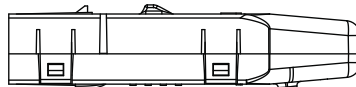

Side view of 4 port RapidNet Cassette

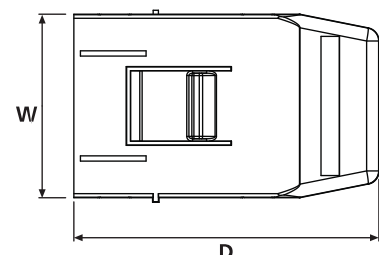

Top view of 4 port RapidNet Cassette



RapidNet 4 Port Category 5e Cassette to RJ45 Plug

Features and Benefits

- Exceeds Category 5e performance standards
- Factory pre-terminated and tested
- Reduce installation times by up to 85%
- Ideal solution when connecting with active equipment
- Backward compatible with Category 5 and voice



Cassette to plug can be used as an inter-connect with active hardware

Product Description

The RapidNet Cassette to Plug option has been specially designed for cabinet to active equipment installations.

The use of the full cross-connect solution reduces the risk of damage to the ports on expensive active equipment. When used for server connectivity it simplifies the management of connections to each unit without accessing the rear of the data cabinets.

Technical Data Table

Article-No.	Type	Performance Category	Height (H)	Width (W)	Depth (D)	Length (L)	Port count	Colour
859-40872	RN04U5E-CAPLXX-10.0M	Category 5E (Class D)	28.0	70.0	116.0	10.0 m	4	Violet (VT)

All dimensions in mm. Subject to technical changes.

Technical Description

Designed as a cross-connect solution, each plug is individually terminated and tested to ensure the highest possible performance.

The RapidNet Cassette offers rear cable management and strain relief to all four cables to protect the cable and the terminations.

RapidNet terminations are tested to exceed all ISO/IEC 11801 and ANSI/TIA/EIA 568-C.2 Category 5e standards.

All RapidNet Category 5e cables are made with LS0H material, complying with the latest European fire ratings.

NB. Part Number is given for a 10m loom as an example. Lengths are available from 1m to 90m.

Technical Drawings

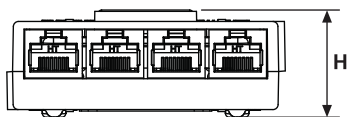

Front view of 4 port RapidNet Cassette

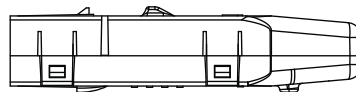

Side view of 4 port RapidNet Cassette

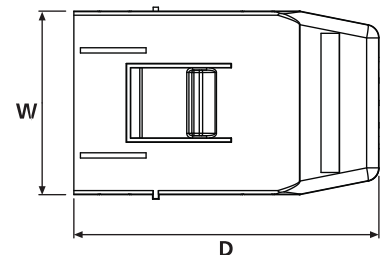

Top view of 4 port RapidNet Cassette



RapidNet 4 Port Category 5e Cassette to Pod

Features and Benefits

- Exceeds Category 5e performance standards
- Factory pre-terminated and tested
- Can be used as a 'to the desk' installation
- Provides 4 Alpha Snap outlets per pod
- Fits into standard floorboxes



The RapidNet Pod fits into a wide range of floor boxes for work area solutions

Product Description

The Cassette to Pod option is designed to support any 'to the desk' installation in various commercial environments including offices, trading floors and schools.

The pod can be mounted to the desk, snapped directly into a floor box aperture or used beneath a raised floor or in the ceiling void as a consolidation point.

The 4 port RapidNet Pod is manufactured with four Category 5e Alpha Snap Outlets.

Technical Data Table

Article-No.	Type	Performance Category	Height (H)	Width (W)	Depth (D)	Length (L)	Port count	Colour
859-00318	RN04U5E-CAPOXX-10.0M	Category 5E (Class D)	59.0	61.0	184.0	10.0 m	4	Violet (VT)

All dimensions in mm. Subject to technical changes.

Technical Description

The RapidNet Pod can also be used as a consolidation point under the floor or within a ceiling void, adding more flexibility to any network infrastructure.

The pod is designed to clip into standard floor boxes via a suitable floor box mounting plate. The rounded edges alleviate snagging during the pulling and fixing stages of an installation. For protection during delivery, the pod is inserted within the cable reel and up to 5 metres of the cable can be protected by a black copex sleeve (on request).

During installation the pod can be slipped off the reel ready to be pulled into position.

All RapidNet Category 5e cables are made with L50H material, complying with the latest European fire ratings.

RapidNet terminations are tested to exceed all ISO/IEC 11801 and ANSI/TIA/EIA 568-C.2 Category 5e standards.

NB. Part Number is given for a 10m loom as an example. Lengths are available from 5m to 90m.

Technical Drawings

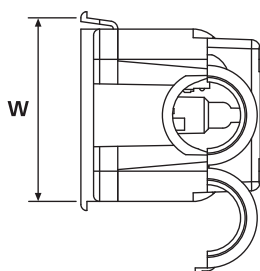

End view of RapidNet Pod showing cable entry point

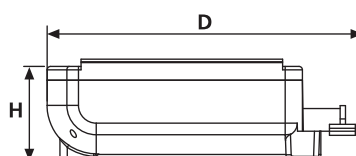

Side view of RapidNet Pod

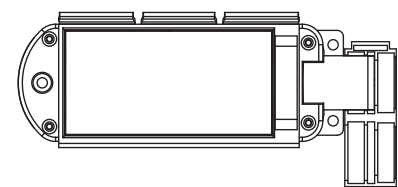

Top view of RapidNet Pod showing cable entry clamp



RapidNet 4 Port Category 5e Cassette to Bare End

Features and Benefits

- Exceeds Category 5e performance standards
- Factory pre-terminated and tested
- Reduce installation times by up to 85%
- Ideal solution where space is limited
- Backward compatible with Category 5 and voice

5e

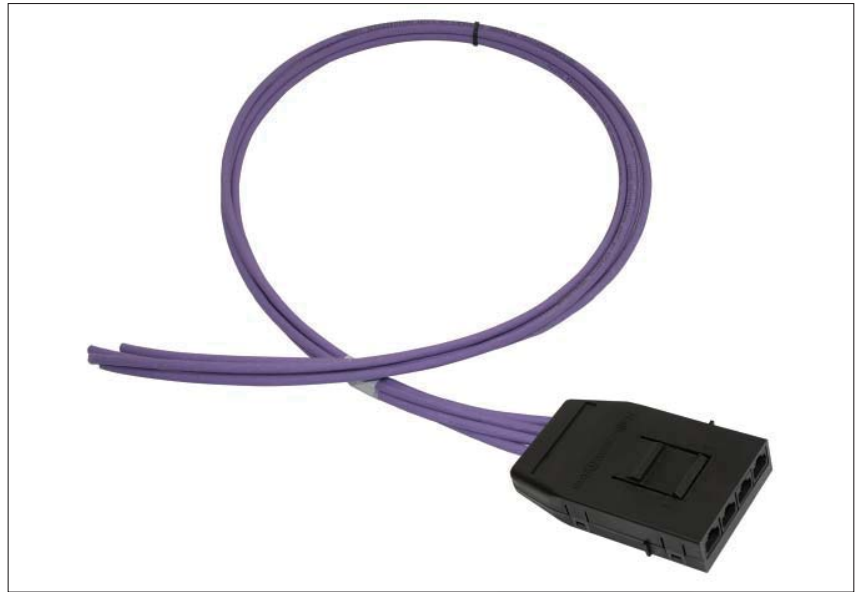

The 4 port Bare End option offers flexibility during installation

Product Description

The 4 port Cassette to Bare End RapidNet option is specifically designed for projects where space between rooms is limited or lengths are uncertain at the planning stage. The bare end can then be terminated to specified outlets or panels making it an ideal solution for offices, call centres and data centres.

Technical Data Table

Article-No.	Type	Performance Category	Height (H)	Width (W)	Depth (D)	Length (L)	Port count	Colour
859-10839	RN04U5E-CABEXX-10.0M	Category 5E (Class D)	28.0	70.0	116.0	10.0 m	4	Violet (VT)

All dimensions in mm. Subject to technical changes.

Technical Description

The RapidNet Bare End option is designed to provide easier access with limited space or apertures between rooms. The 4 bare ends can then be terminated to either a patch panel in the comms room or to outlets at the desk.

All RapidNet Category 5e cables are made with LS0H material, complying with the latest European fire ratings.

RapidNet terminations are tested to exceed all ISO/IEC 11801 and ANSI/TIA/EIA 568-C.2 Category 5e standards.

NB. Part Number is given for a 10m loom as an example. Lengths are available from 5m to 90m.

Technical Drawings

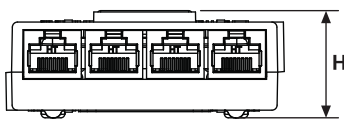

Front view of 4 port RapidNet Cassette

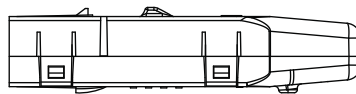

Side view of 4 port RapidNet Cassette

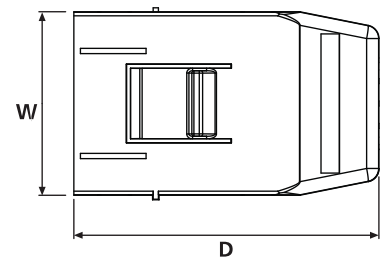

Top view of 4 port RapidNet Cassette



RapidNet MTP VHD 144 Core 6 MTP Cassette to Cassette

Features and Benefits

- Up to 576 fibres in 1U of Space
- High performance low loss Elite® connectors from US Conec
- 40G and 100G ready
- Significantly reduced installation times
- Available in OM3, OM4 and OS1
- Dual labelling fields
- Interchangeable with other RapidNet Cassettes
- Pre-tested with test results supplied



The 6 port MTP VHD offers up to 144 fibres per cassette

Product Description

The RapidNet MTP VHD solution has been designed to meet the demands of the data centre by providing reduced installation times, efficient use of space, flexible configurations and high performance.

RapidNet MTP VHD enables up to 576 fibres in a single U of rack space. Each VHD cassette presents six 24 core MTP connectors.

Technical Data Table

Article-No.	Type	Performance Category	Height (H)	Width (W)	Depth (D)	Length (L)	Port count
860-00153	RNFT6H4-MCMCM3-10.0M	OM3 Multimode	27.0	102.0	130.0	10.0 m	6
860-00154	RNFT6H4-MCMCM4-10.0M	OM4 Multimode	27.0	102.0	130.0	10.0 m	6
860-00152	RNFT6H4-MCMCS1-10.0M	OS1 Single Mode	27.0	102.0	130.0	10.0 m	6

All dimensions in mm. Subject to technical changes.

Technical Description

The use of high performance low loss Elite® MTP connectors from US Conec as standard minimises losses across the link and provides a potential upgrade path from 10G through to 40G and 100G.

Part of the industry leading RapidNet pre-terminated system, this high density fibre solution is particularly suited for use in Storage Area Network (SAN) applications.

NB. Part Number is given for a 10m loom as an example. Other lengths are available on request that meet the maximum distance performances defined in ISO/IEC 11801-2 and TIA/ANSI 568-C.2

Technical Drawings

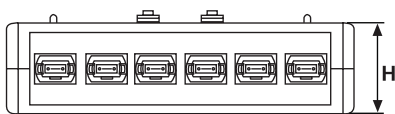

Front view of 6 port MTP VHD Cassette



Side view of 6 port MTP VHD RapidNet Cassette

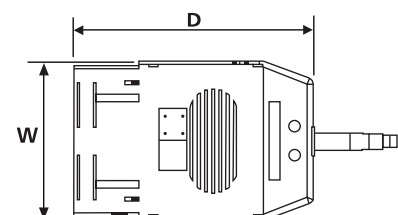

Top view of 6 port MTP VHD RapidNet Cassette



RapidNet MTP VHD 144 Core 12 MTP Cassette to Cassette

Features and Benefits

- Up to 576 fibres in 1U of Space
- High performance low loss Elite® connectors from US Conec
- 40G and 100G ready
- Significantly reduced installation times
- Available in OM3, OM4 and OS1
- Dual labelling fields
- Interchangeable with other RapidNet Cassettes
- Pre-tested with test results supplied



The 12 port MTP VHD offers up to 144 fibres per cassette

Product Description

The RapidNet MTP VHD solution has been designed to meet the demands of the data centre by providing reduced installation times, efficient use of space, flexible configurations and high performance.

RapidNet MTP VHD enables upto 576 fibres in a single U of rack space. Each VHD cassette presents twelve 12 core MTP connectors.

Technical Data Table

Article-No.	Type	Performance Category	Height (H)	Width (W)	Depth (D)	Length (L)	Port count
860-00156	RNFTVH4-MCMCM3-10.0M	OM3 Multimode	27.0	102.0	130.0	10.0 m	12
860-00157	RNFTVH4-MCMCM4-10.0M	OM4 Multimode	27.0	102.0	130.0	10.0 m	12
860-00155	RNFTVH4-MCMCS1-10.0M	OS1 Single Mode	27.0	102.0	130.0	10.0 m	12

All dimensions in mm. Subject to technical changes.

Technical Description

The use of high performance low loss Elite® MTP connectors from US Conec as standard minimises losses across the link and provides a potential upgrade path from 10G through to 40G and 100G.

Part of the industry leading RapidNet pre-terminated system, this high density fibre solution is particularly suited for use in Storage Area Network (SAN) applications.

NB. Part Number is given for a 10m loom as an example. Other lengths are available on request that meet the maximum distance performances defined in ISO/IEC 11801-2 and TIA/ANSI 568-C.2

Technical Drawings

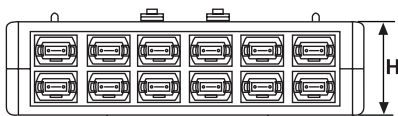

Front View of the MTP VHD 12 port Cassette



Side View of the MTP VHD 12 port Cassette

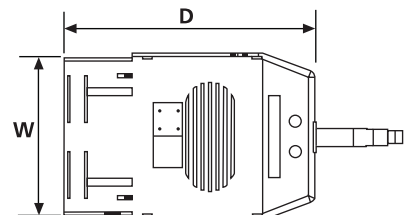

Top View of the MTP VHD 12 port Cassette



RapidNet MTP VHD 144 Core 6 MTP Cassette to MTP Fan Out

Features and Benefits

- Up to 576 fibres in 1U of Space
- High performance low loss Elite® connectors from US Conec
- 40G and 100G ready
- Significantly reduced installation times
- Available in OM3, OM4 and OS1
- Dual labelling fields
- Interchangeable with other RapidNet Cassettes
- Pre-tested with test results supplied

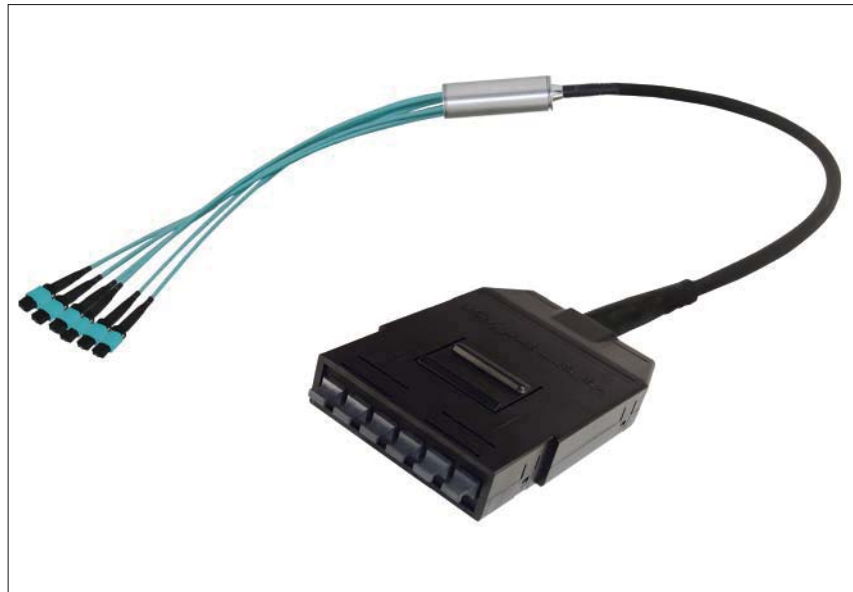

MTP VHD 6 port Cassette to Fan Out - provides up to 144 fibre high density connectivity

Product Description

The RapidNet MTP VHD solution has been designed to meet the demands of the data centre by providing reduced installation times, efficient use of space, flexible configurations and high performance.

RapidNet MTP VHD enables upto 576 fibres in a single U of rack space. The VHD cassette presents six 24 core MTP connectors with a fan out of six 24 core MTP's at the other end.

Technical Data Table

Article-No.	Type	Performance Category	Height (H)	Width (W)	Depth (D)	Length (L)	Port count
860-00162	RNFT6H4-MCMDM3-10.0M	OM3 Multimode	27.0	102.0	130.0	10.0 m	6
860-00163	RNFT6H4-MCMDM4-10.0M	OM4 Multimode	27.0	102.0	130.0	10.0 m	6
860-00161	RNFT6H4-MCMDS1-10.0M	OS1 Single Mode	27.0	102.0	130.0	10.0 m	6

All dimensions in mm. Subject to technical changes.

Technical Description

The use of high performance low loss Elite® MTP connectors from US Conec as standard minimises losses across the link and provides a potential upgrade path from 10G through to 40G and 100G.

Part of the industry leading RapidNet pre-terminated system, this high density fibre solution is particularly suited for use in Storage Area Network (SAN) applications.

NB. Part Number is given for a 10m loom as an example. Other lengths are available on request that meet the maximum distance performances defined in ISO/IEC 11801-2 and TIA/ANSI 568-C.2. The standard fan out breakout length is 0.5m for loom lengths between 2m to 5m and 1m for loom lengths over 5m.

Technical Drawings

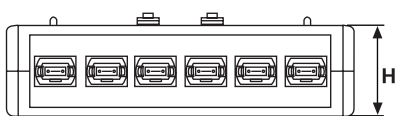

Front view of 6 port MTP VHD Cassette

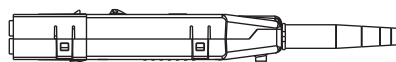

Side view of 6 port MTP VHD RapidNet Cassette

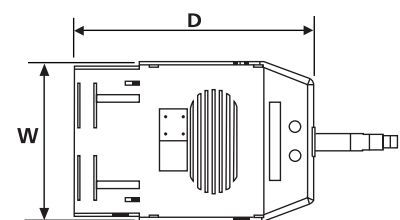

Top view of 6 port MTP VHD RapidNet Cassette



RapidNet MTP VHD 144 Core 12 MTP Cassette to MTP Fan Out

Features and Benefits

- Up to 576 fibres in 1U of Space
- High performance low loss Elite® connectors from US Conec
- 40G and 100G ready
- Significantly reduced installation times
- Available in OM3, OM4 and OS1
- Dual labelling fields
- Interchangeable with other RapidNet Cassettes
- Pre-tested with test results supplied



MTP VHD 12 port Cassette to Fan Out - provides up to 144 fibre high density connectivity

Product Description

The RapidNet MTP VHD solution has been designed to meet the demands of the data centre by providing reduced installation times, efficient use of space, flexible configurations and high performance.

RapidNet MTP VHD enables upto 576 fibres in a single U of rack space. The VHD cassette presents twelve 12 core MTP connectors with a fan out of twelve 12 core MTP's at the other end.

Technical Data Table

Article-No.	Type	Performance Category	Height (H)	Width (W)	Depth (D)	Length (L)	Port count
860-00165	RNFTVH4-MCMDM3-10.0M	OM3 Multimode	27.0	102.0	130.0	10.0 m	12
860-00166	RNFTVH4-MCMDM4-10.0M	OM4 Multimode	27.0	102.0	130.0	10.0 m	12
860-00164	RNFTVH4-MCSDS1-10.0M	OS1 Single Mode	27.0	102.0	130.0	10.0 m	12

All dimensions in mm. Subject to technical changes.

Technical Description

The use of high performance low loss Elite® MTP connectors from US Conec as standard minimises losses across the link and provides a potential upgrade path from 10G through to 40G and 100G.

Part of the industry leading RapidNet pre-terminated system, this high density fibre solution is particularly suited for use in Storage Area Network (SAN) applications.

NB. Part Number is given for a 10m loom as an example. Other lengths are available on request that meet the maximum distance performances defined in ISO/IEC 11801-2 and TIA/ANSI 568-C.2. The standard fan out breakout length is 0.5m for loom lengths between 2m to 5m and 1m for loom lengths over 5m.

Technical Drawings

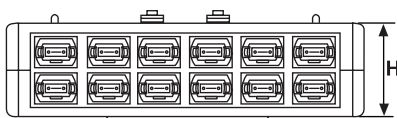

Front View of the MTP VHD 12 port Cassette



Side View of the MTP VHD 12 port Cassette

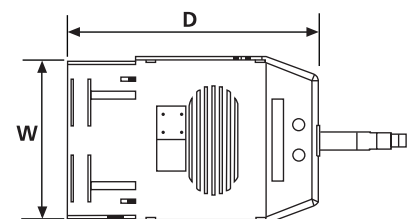

Top View of the MTP VHD 12 port Cassette



RapidNet MTP VHD 72 Core 6 MTP Cassette to Cassette

Features and Benefits

- Up to 288 fibres in 1U of Space
- High performance low loss Elite® connectors from US Conec
- 40G and 100G ready
- Significantly reduced installation times
- Available in OM3, OM4 and OS1
- Dual labelling fields
- Interchangeable with other RapidNet Cassettes
- Pre-tested with test results supplied



The 6 port MTP VHD offers up to 72 fibre per cassette.

Product Description

The RapidNet MTP VHD solution has been designed to meet the demands of the data centre by providing reduced installation times, efficient use of space, flexible configurations and high performance.

RapidNet MTP VHD enables upto 288 fibres in a single U of rack space. Each VHD cassette presents six 12 core MTP connectors.

Technical Data Table

Article-No.	Type	Performance Category	Height (H)	Width (W)	Depth (D)	Length (L)	Port count
860-00106	RNFT672-MCMCM3-10.0M	OM3 Multimode	27.0	102.0	130.0	10.0 m	6
860-00000	RNFT672-MCMCM4-10.0M	OM4 Multimode	27.0	102.0	130.0	10.0 m	6
860-00047	RNFT672-MCMCS1-10.0M	OS1 Single Mode	27.0	102.0	130.0	10.0 m	6

All dimensions in mm. Subject to technical changes.

Technical Description

The use of high performance low loss Elite® MTP connectors from US Conec as standard minimises losses across the link and provides a potential upgrade path from 10G through to 40G and 100G.

Part of the industry leading RapidNet pre-terminated system, this high density fibre solution is particularly suited for use in Storage Area Network (SAN) applications.

NB. Part Number is given for a 10m loom as an example. Other lengths are available on request that meet the maximum distance performances defined in ISO/IEC 11801-2 and TIA/ANSI 568-C.2.

Technical Drawings

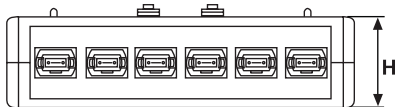

Front view of 6 port MTP VHD Cassette



Side view of 6 port MTP VHD RapidNet Cassette

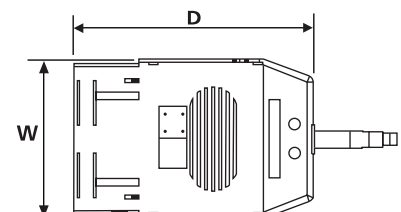

Top view of 6 port MTP VHD RapidNet Cassette



RapidNet MTP VHD 72 Core 6 MTP Cassette to MTP Fan Out

Features and Benefits

- Up to 288 fibres in 1U of Space
- High performance low loss Elite® connectors from US Conec
- 40G and 100G ready
- Significantly reduced installation times
- Available in OM3, OM4 and OS1
- Dual labelling fields
- Interchangeable with other RapidNet Cassettes
- Pre-tested with test results supplied

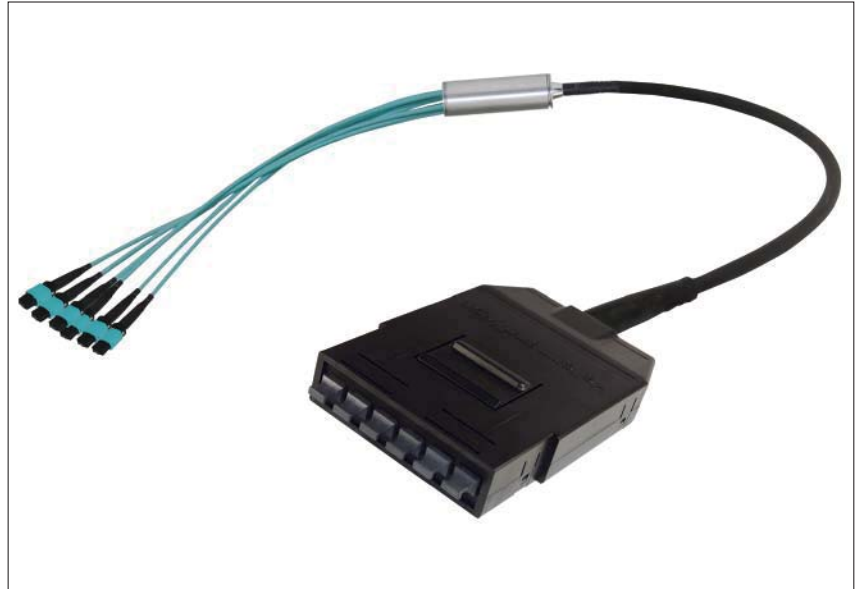

MTP VHD 6 port Cassette to Fan Out - provides up to 288 fibre connectivity in 1U

Product Description

The RapidNet MTP VHD solution has been designed to meet the demands of the data centre by providing reduced installation times, efficient use of space, flexible configurations and high performance.

RapidNet MTP VHD enables upto 288 fibres in a single U of rack space. The VHD cassette presents six 12 core MTP connectors with a fan out of six 12 core MTP's at the other end.

Technical Data Table

Article-No.	Type	Performance Category	Height (H)	Width (W)	Depth (D)	Length (L)	Port count
860-00159	RNFT672-MCMDM3-10.0M	OM3 Multimode	27.0	102.0	130.0	10.0 m	6
860-00160	RNFT672-MCMDM4-10.0M	OM4 Multimode	27.0	102.0	130.0	10.0 m	6
860-00158	RNFT672-MCMDS1-10.0M	OS1 Single Mode	27.0	102.0	130.0	10.0 m	6

All dimensions in mm. Subject to technical changes.

Technical Description

The use of high performance low loss Elite® MTP connectors from US Conec as standard minimises losses across the link and provides a potential upgrade path from 10G through to 40G and 100G.

Part of the industry leading RapidNet pre-terminated system, this high density fibre solution is particularly suited for use in Storage Area Network (SAN) applications.

NB. Part Number is given for a 10m loom as an example. Other lengths are available on request that meet the maximum distance performances defined in ISO/IEC 11801-2 and TIA/ANSI 568-C.2. The standard fan out breakout length is 0.5m for loom lengths between 2m to 5m and 1m for loom lengths over 5m.

Technical Drawings

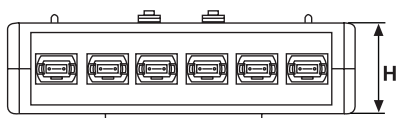

Front view of 6 port MTP VHD Cassette

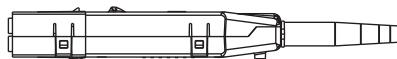

Side view of 6 port MTP VHD RapidNet Cassette

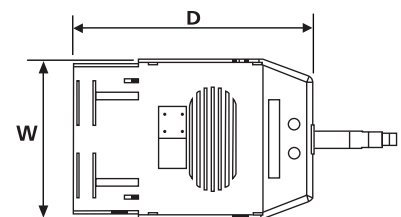

Top view of 6 port MTP VHD RapidNet Cassette



RapidNet MTP VHD 72 Core 6 MTP Cassette to LC Fan Out

Features and Benefits

- Up to 288 fibres in 1U of Space
- High performance low loss Elite® connectors from US Conec
- 40G and 100G ready
- Significantly reduced installation times
- Available in OM3, OM4 and OS1
- Dual labelling fields
- LC connectors allow inter-connect with active hardware
- Pre-tested with test results supplied

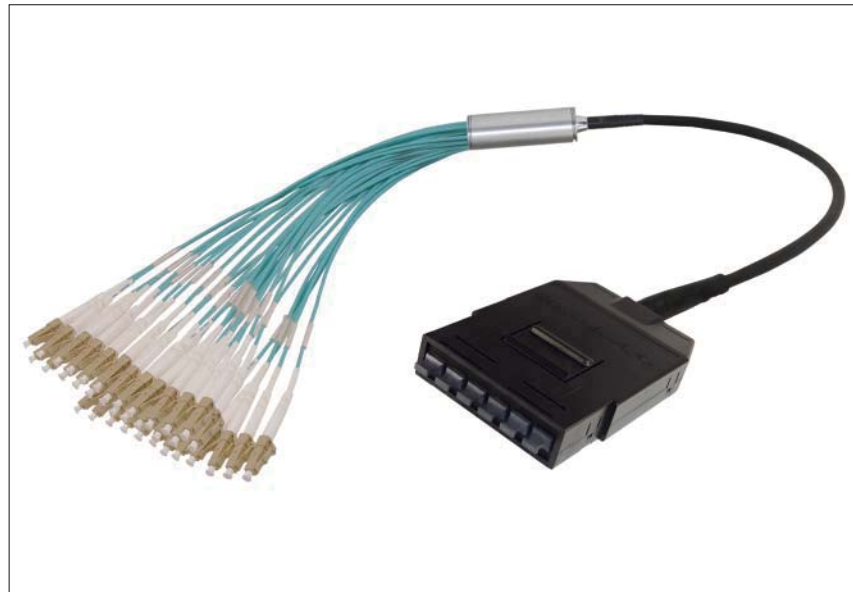

MTP to 72 LC Fan Out ideal for high performance fibre patching

Product Description

The RapidNet MTP VHD solution has been designed to meet the demands of the data centre by providing reduced installation times, efficient use of space, flexible configurations and high performance.

RapidNet MTP VHD enables upto 288 fibres in a single U of rack space. The VHD cassette presents six 12 core MTP connectors with a fan out of 72 LC connectors at the other end.

Technical Data Table

Article-No.	Type	Performance Category	Height (H)	Width (W)	Depth (D)	Length (L)	Port count
860-00168	RNFT672-MCLFM3-10.0M	OM3 Multimode	27.0	102.0	130.0	10.0 m	6
860-00169	RNFT672-MCLFM4-10.0M	OM4 Multimode	27.0	102.0	130.0	10.0 m	6
860-00167	RNFT672-MCLFS1-10.0M	OS1 Single Mode	27.0	102.0	130.0	10.0 m	6

All dimensions in mm. Subject to technical changes.

Technical Description

The use of high performance low loss Elite® MTP connectors from US Conec as standard minimises losses across the link and provides a potential upgrade path from 10G through to 40G and 100G.

Part of the industry leading RapidNet pre-terminated system, this high density fibre solution is particularly suited for use in Storage Area Network (SAN) applications.

NB. Part Number is given for a 10m loom as an example. Other lengths are available on request that meet the maximum distance performances defined in ISO/IEC 11801-2 and TIA/ANSI 568-C.2. The standard fan out breakout length is 0.5m for loom lengths between 2m to 5m and 1m for loom lengths over 5m.

Technical Drawings

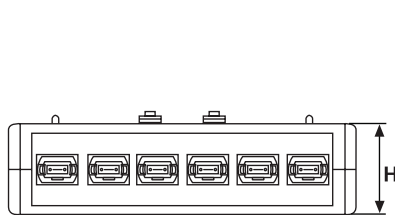

Front view of 6 port MTP VHD Cassette



Side view of 6 port MTP VHD RapidNet Cassette

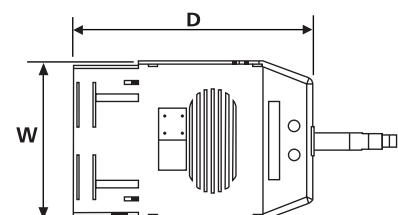

Top view of 6 port MTP VHD RapidNet Cassette



RapidNet Fibre LC 24 Core Cassette to Cassette

Features and Benefits

- Up to 96 fibres in 1U of Space
- Significantly reduced installation times
- Available in OM3, OM4 and OS1
- Dual labelling fields
- Interchangeable with other RapidNet Cassettes
- Pre-tested with test results supplied



The 24 port LC RapidNet Cassette is available in OM3, OM4 and OS1 versions to specified lengths

Product Description

The RapidNet Fibre Cassette is pre-terminated offering LC connectivity in either single mode or multimode. LC cassettes offer up to 24 ports in one cassette.

Each cassette fits into the RapidNet Panel, which accepts 4 cassettes in 1U of space, achieving a maximum of 96 fibre ports in 1U.

RapidNet Fibre Cassettes are pre-terminated and pre-tested, installation time can be reduced by up to 85% and virtually eliminating the risk of dust and dirt affecting the connectivity and overall performance.

Technical Data Table

Article-No.	Type	Performance Category	Height (H)	Width (W)	Depth (D)	Length (L)	Port count
859-20624	RNFTD24-LCLCM3-10.0M	OM3 Multimode	27.0	102.0	130.0	10.0 m	24
859-21654	RNFTD24-LCLCM4-10.0M	OM4 Multimode	27.0	102.0	130.0	10.0 m	24
859-20875	RNFTD24-LCLCS1-10.0M	OS1 Single Mode	27.0	102.0	130.0	10.0 m	24

All dimensions in mm. Subject to technical changes.

Technical Description

The RapidNet Fibre LC Cassette offers 24 ports using pre-terminated OM3, OM4 or OS1 fibre cable.

The fibre is pre-terminated in a clean factory environment and all terminations are pre-tested before the product is sent to our customers. The fibre cable is secured and protected by a rubber boot on entry into the cassette.

Individual fibres are managed within the cassettes using positive bend radius management to ensure minimum losses and maximum performance.

NB. Part Number is given for a 10m loom as an example. Other lengths are available on request that meet the maximum distance performances defined in ISO/IEC 11801-2 and TIA/ANSI 568-C.2.

Technical Drawings



Front View of the 24 port LC RapidNet Fibre Cassette



Side View of the 24 port LC RapidNet Fibre Cassette

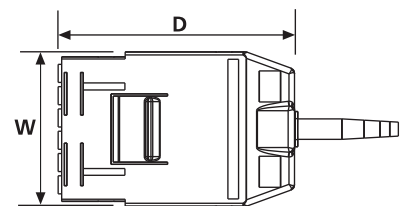

Top View of the 24 port LC RapidNet Fibre Cassette



**RapidNet Fibre LC 24 Core
Cassette with 2 Rear MTP Connectivity**

Features and Benefits

- Up to 96 fibres in 1U of Space
- Significantly reduced installation times
- Available in OM3, OM4 and OS1
- Dual labelling fields
- Interchangeable with other RapidNet Cassettes
- MTP rear connectors ideal for installations in areas of limited space
- Pre-tested with test results supplied



The 24 Fibre LC Cassette has two 12 core MTP connectors at the rear for easy installation

Product Description

The RapidNet Fibre Cassette is pre-terminated offering LC connectivity in either single mode or multimode. LC cassettes offer up to 24 ports in one cassette.

Each cassette fits into the RapidNet Panel, which accepts 4 cassettes in 1U of space, achieving a maximum of 96 fibre ports in 1U.

RapidNet Fibre Cassettes are pre-terminated and pre-tested, installation time can be reduced by up to 85% and virtually eliminating the risk of dust and dirt affecting the connectivity and overall performance.

Technical Data Table

Article-No.	Type	Performance Category	Height (H)	Width (W)	Depth (D)	Port count
859-21667	RNFTD-24LCMMM3-XX.XX	OM3 Multimode	27.0	102.0	130.0	24
859-21668	RNFTD-24LCMMM4-XX.XX	OM4 Multimode	27.0	102.0	130.0	24
859-21666	RNFTD-24LCMMS1-XX.XX	OS1 Single Mode	27.0	102.0	130.0	24

All dimensions in mm. Subject to technical changes.

Technical Description

The RapidNet Fibre LC Cassette offers 24 ports using pre-terminated OM3, OM4 or OS1 fibre cable.

The fibre is pre-terminated in a clean factory environment and all terminations are pre-tested before the product is sent to our customers. The fibre cassette has 2 MTP connectors on the rear for use with MTP back bone cables or fan outs.

Individual fibres are managed within the cassettes using positive bend radius management to ensure minimum losses and maximum performance.

Technical Drawings



Front View of 24 core LC Cassette with MTP connectors on rear

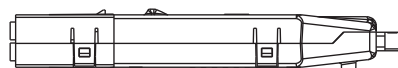

Side View of 24 core LC Cassette with MTP connectors on rear

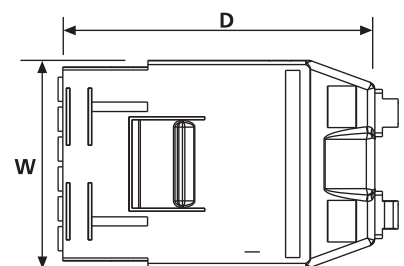

Top View of 24 core LC Cassette with MTP connectors on rear



RapidNet Fibre LC 24 Core Cassette with 1 Rear MTP Connectivity

Features and Benefits

- Up to 96 fibres in 1U of Space
- Significantly reduced installation times
- Available in OM3, OM4 and OS1
- Dual labelling fields
- Interchangeable with other RapidNet Cassettes
- MTP rear connector ideal for installations in areas of limited space
- Pre-tested with test results supplied



The 24 Fibre LC Cassette has a single 24 core MTP connector at the rear for easy installation

Product Description

The RapidNet Fibre Cassette is pre-terminated offering LC connectivity in either single mode or multimode. LC cassettes offer up to 24 ports in one cassette.

Each cassette fits into the RapidNet Panel, which accepts 4 cassettes in 1U of space, achieving a maximum of 96 fibre ports in 1U.

RapidNet Fibre Cassettes are pre-terminated and pre-tested, installation time can be reduced by up to 85% and virtually eliminating the risk of dust and dirt affecting the connectivity and overall performance.

Technical Data Table

Article-No.	Type	Performance Category	Height (H)	Width (W)	Depth (D)	Port count
859-21680	RNFTD-24LC1MM3-XX.XX	OM3 Multimode	27.0	102.0	130.0	24
859-21681	RNFTD-24LC1MM4-XX.XX	OM4 Multimode	27.0	102.0	130.0	24
859-21679	RNFTD-24LC1MS1-XX.XX	OS1 Single Mode	27.0	102.0	130.0	24

All dimensions in mm. Subject to technical changes.

Technical Description

The RapidNet Fibre LC Cassette offers 24 ports using pre-terminated OM3, OM4 or OS1 fibre cable.

The fibre is pre-terminated in a clean factory environment and all terminations are pre-tested before the product is sent to our customers. The fibre cassette has a single 24 core MTP connector on the rear for use with MTP back bone cables or fan outs.

Individual fibres are managed within the cassettes using positive bend radius management to ensure minimum losses and maximum performance.

Technical Drawings



Front View of 24 Core LC Cassette
with 1 MTP Connector

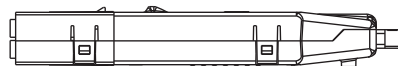

Side View of 24 Core LC Cassette
with 1 MTP Connector

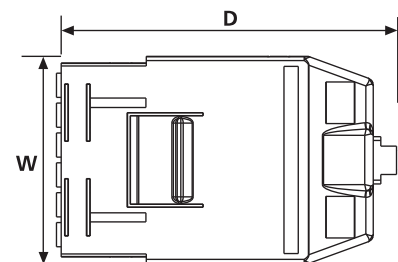

Top View of 24 Core LC Cassette
with 1 MTP Connector



RapidNet Fibre LC 24 Core Cassette to LC Fan Out

Features and Benefits

- Up to 96 fibres in 1U of Space
- Significantly reduced installation times
- Available in OM3, OM4 and OS1
- Dual labelling fields
- Interchangeable with other RapidNet Cassettes
- LC fan out enables inter-connectivity with active hardware
- Pre-tested with test results supplied

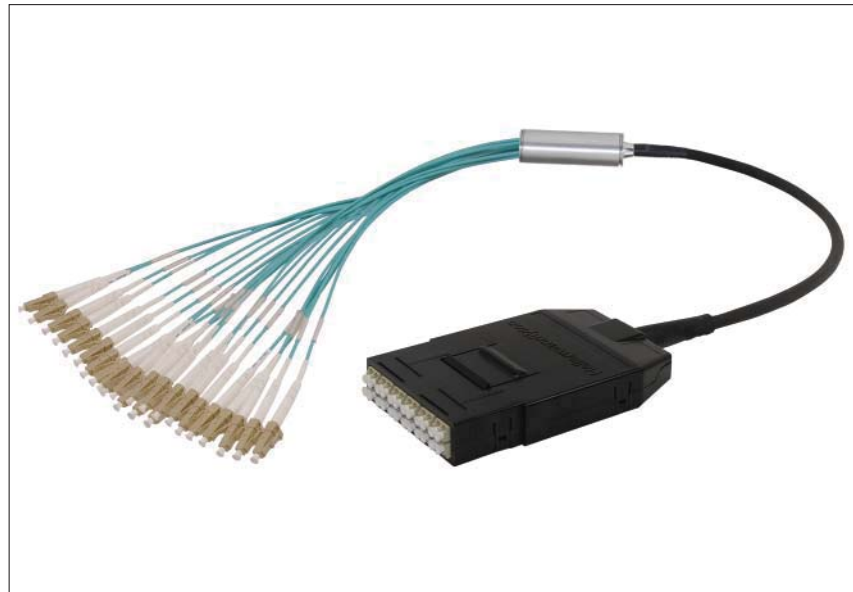

24 port LC RapidNet Cassette to 24 LC Fan Out

Product Description

The RapidNet Fibre Cassette is pre-terminated offering LC connectivity in either single mode or multimode. LC cassettes offer up to 24 ports in one cassette.

Each cassette fits into the RapidNet Panel, which accepts 4 cassettes in 1U of space, achieving a maximum of 96 fibre ports in 1U.

RapidNet Fibre Cassettes are pre-terminated and pre-tested, installation time can be reduced by up to 85% and virtually eliminating the risk of dust and dirt affecting the connectivity and overall performance.

Technical Data Table

Article-No.	Type	Performance Category	Height (H)	Width (W)	Depth (D)	Length (L)	Port count
859-20805	RNFTD24-LCLFM3-10.0M	OM3 Multimode	27.0	102.0	130.0	10.0 m	24
859-21656	RNFTD-24LCLFM4-10.0M	OM4 Multimode	27.0	102.0	130.0	10.0 m	24
859-21254	RNFTD24-LCLFS1-10.0M	OS1 Single Mode	27.0	102.0	130.0	10.0 m	24

All dimensions in mm. Subject to technical changes.

Technical Description

The RapidNet Fibre LC Cassette offers 24 ports using pre-terminated OM3, OM4 or OS1 fibre cable.

The fibre is pre-terminated in a clean factory environment and all terminations are pre-tested before the product is sent to our customers. The fibre cable is secured and protected by a rubber boot on entry into the cassette. The fibre is then separated using a splitter unit with the LC fan outs presented to specified lengths.

NB. Part Number is given for a 10m loom as an example. Other lengths are available on request that meet the maximum distance performances defined in ISO/IEC 11801-2 and TIA/ANSI 568-C.2. The standard fan out breakout length is 0.5m for loom lengths between 2m to 5m and 1m for loom lengths over 5m.

Technical Drawings

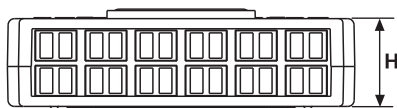

Front View of the 24 port LC RapidNet Fibre Cassette



Side View of the 24 port LC RapidNet Fibre Cassette

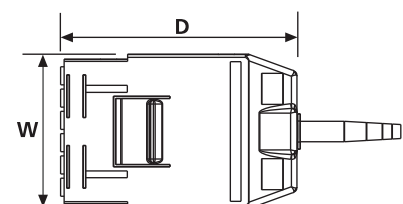

Top View of the 24 port LC RapidNet Fibre Cassette



RapidNet Fibre LC 24 Core Cassette to SC Fan Out

Features and Benefits

- Up to 96 fibres in 1U of Space
- Significantly reduced installation times
- Available in OM3, OM4 and OS1
- Dual labelling fields
- Interchangeable with other RapidNet Cassettes
- SC fan out enables inter-connectivity with active hardware
- Pre-tested with test results supplied

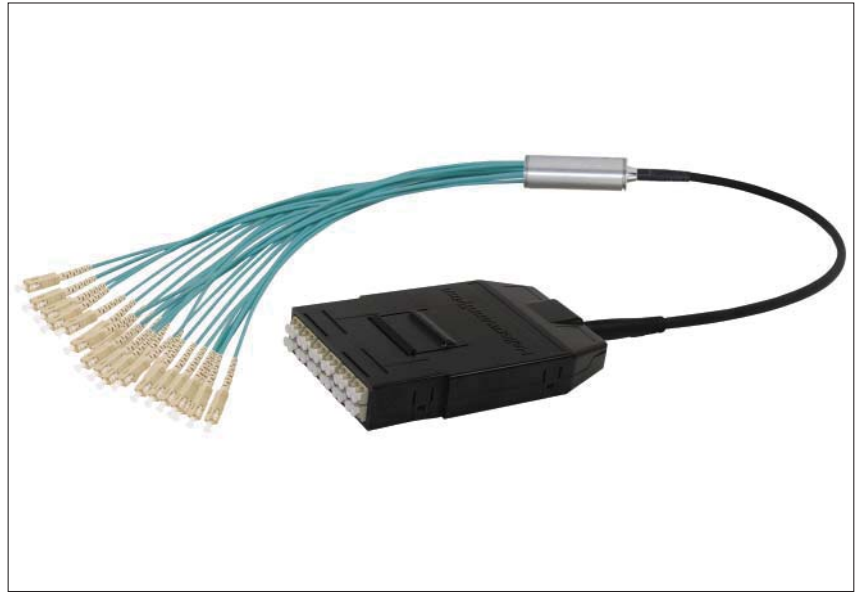

24 Core LC RapidNet Cassette to 24 SC Fan Out

Product Description

The RapidNet Fibre Cassette is pre-terminated offering LC connectivity in either single mode or multimode. LC cassettes offer up to 24 ports in one cassette.

Each cassette fits into the RapidNet Panel, which accepts 4 cassettes in 1U of space, achieving a maximum of 96 fibre ports in 1U.

RapidNet Fibre Cassettes are pre-terminated and pre-tested, installation time can be reduced by up to 85% and virtually eliminating the risk of dust and dirt affecting the connectivity and overall performance.

Technical Data Table

Article-No.	Type	Performance Category	Height (H)	Width (W)	Depth (D)	Length (L)	Port count
859-21661	RNFTD-24LCSFM3-10.0M	OM3 Multimode	27.0	102.0	130.0	10.0 m	24
859-21662	RNFTD-24LCSFM4-10.0M	OM4 Multimode	27.0	102.0	130.0	10.0 m	24
859-21660	RNFTD-24LCSFS1-10.0M	OS1 Single Mode	27.0	102.0	130.0	10.0 m	24

All dimensions in mm. Subject to technical changes.

Technical Description

The RapidNet Fibre LC Cassette offers 24 ports using pre-terminated OM3, OM4 or OS1 fibre cable.

The fibre is pre-terminated in a clean factory environment and all terminations are pre-tested before the product is sent to our customers. The fibre cable is secured and protected by a rubber boot on entry into the cassette. The fibre is then separated using a splitter unit with the SC fan outs presented to specified lengths.

NB. Part Number is given for a 10m loom as an example. Other lengths are available on request that meet the maximum distance performances defined in ISO/IEC 11801-2 and TIA/ANSI 568-C.2. The standard fan out breakout length is 0.5m for loom lengths between 2m to 5m and 1m for loom lengths over 5m.

Technical Drawings



Front View of the 24 port LC RapidNet Fibre Cassette



Side View of the 24 port LC RapidNet Fibre Cassette

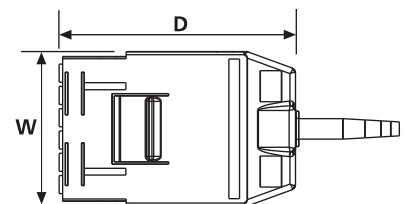

Top View of the 24 port LC RapidNet Fibre Cassette



RapidNet Fibre LC 12 Core Cassette to Cassette

Features and Benefits

- Up to 48 fibres in 1U of Space
- Significantly reduced installation times
- Available in OM3, OM4 and OS1
- Dual labelling fields
- Interchangeable with other RapidNet Cassettes
- Pre-tested with test results supplied

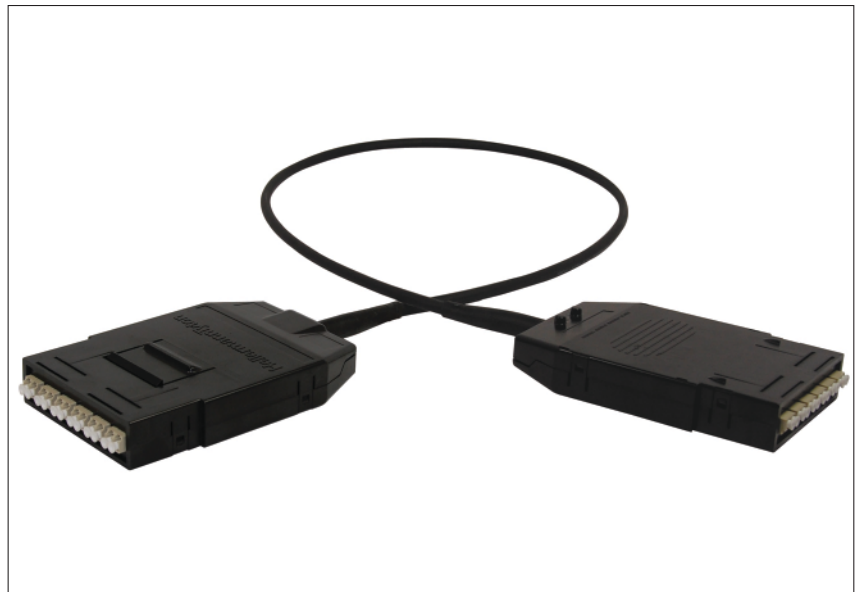

The 12 port LC RapidNet Cassette is available in OM3, OM4 and OS1 versions to specified lengths

Product Description

The RapidNet Fibre Cassette is pre-terminated offering LC connectivity in either single mode or multimode.

Each 12 port cassette fits into the RapidNet Panel, which accepts 4 cassettes in 1U of space, achieving a maximum of 48 fibre ports in 1U.

RapidNet Fibre Cassettes are pre-terminated and pre-tested, installation time can be reduced by up to 85% and virtually eliminating the risk of dust and dirt affecting the connectivity and overall performance.

Technical Data Table

Article-No.	Type	Performance Category	Height (H)	Width (W)	Depth (D)	Length (L)	Port count
859-20622	RNFTD12-LCLCM3-10.0M	OM3 Multimode	27.0	102.0	130.0	10.0 m	12
859-21653	RNFTD-12LCLCM4-10.0M	OM4 Multimode	27.0	102.0	130.0	10.0 m	12
859-20832	RNFTD12-LLCS1-10.0M	OS1 Single Mode	27.0	102.0	130.0	10.0 m	12

All dimensions in mm. Subject to technical changes.

Technical Description

The RapidNet Fibre LC Cassette offers 12 ports using pre-terminated OM3, OM4 or OS1 fibre cable.

The fibre is pre-terminated in a clean factory environment and all terminations are pre-tested before the product is sent to our customers. The fibre cable is secured and protected by a rubber boot on entry into the cassette.

NB. Part Number is given for a 10m loom as an example. Other lengths are available on request that meet the maximum distance performances defined in ISO/IEC 11801-2 and TIA/ANSI 568-C.2.

Technical Drawings

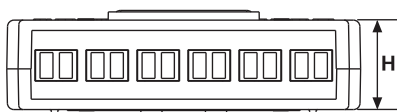

Front View of the 12 port LC RapidNet Fibre Cassette



Side View of the 12 port LC RapidNet Fibre Cassette

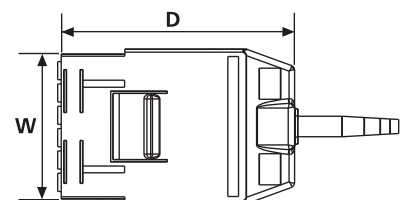

Top View of the 12 port LC RapidNet Fibre Cassette



RapidNet Fibre LC 12 Core Cassette with 1 Rear MTP Connectivity

Features and Benefits

- Up to 48 fibres in 1U of Space
- Significantly reduced installation times
- Available in OM3, OM4 and OS1
- Dual labelling fields
- Interchangeable with other RapidNet Cassettes
- MTP rear connector ideal for installations in areas of limited space
- Pre-tested with test results supplied



12 core LC RapidNet Cassette with MTP connector on rear for fast and easy installation

Product Description

The RapidNet Fibre Cassette is pre-terminated offering LC connectivity in either single mode or multimode.

Each 12 port cassette fits into the RapidNet Panel, which accepts 4 cassettes in 1U of space, achieving a maximum of 48 fibre ports in 1U.

RapidNet Fibre Cassettes are pre-terminated and pre-tested, installation time can be reduced by up to 85% and virtually eliminating the risk of dust and dirt affecting the connectivity and overall performance.

Technical Data Table

Article-No.	Type	Performance Category	Height (H)	Width (W)	Depth (D)	Port count
859-21664	RNFTD-12LCMMM3-XX.XX	OM3 Multimode	27.0	102.0	130.0	12
859-21665	RNFTD-12LCMMM4-XX.XX	OM4 Multimode	27.0	102.0	130.0	12
859-21663	RNFTD-12LCMMS1-XX.XX	OS1 Single Mode	27.0	102.0	130.0	12

All dimensions in mm. Subject to technical changes.

Technical Description

The RapidNet Fibre LC Cassette offers 12 ports using pre-terminated OM3, OM4 or OS1 fibre cable.

The fibre is pre-terminated in a clean factory environment and all terminations are pre-tested before the product is sent to our customers. The fibre cassette has a single 12 core MTP connector on the rear for use with MTP back bone cables or fan outs.

Technical Drawings

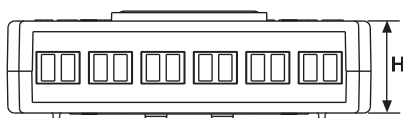

Front View of 12 core LC Cassette
with MTP connector on rear

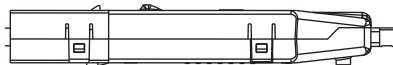

Side View of 12 core LC Cassette
with MTP connector on rear

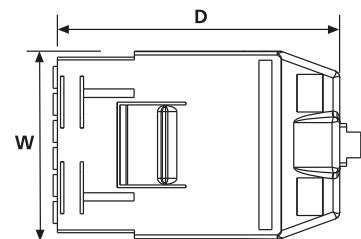

Top View of 12 core LC Cassette
with MTP connector on rear



RapidNet Fibre LC 12 Core Cassette to LC Fan Out

Features and Benefits

- Up to 48 fibres in 1U of Space
- Significantly reduced installation times
- Available in OM3, OM4 and OS1
- Dual labelling fields
- Interchangeable with other RapidNet Cassettes
- LC fan out enables inter-connectivity with active hardware
- Pre-tested with test results supplied

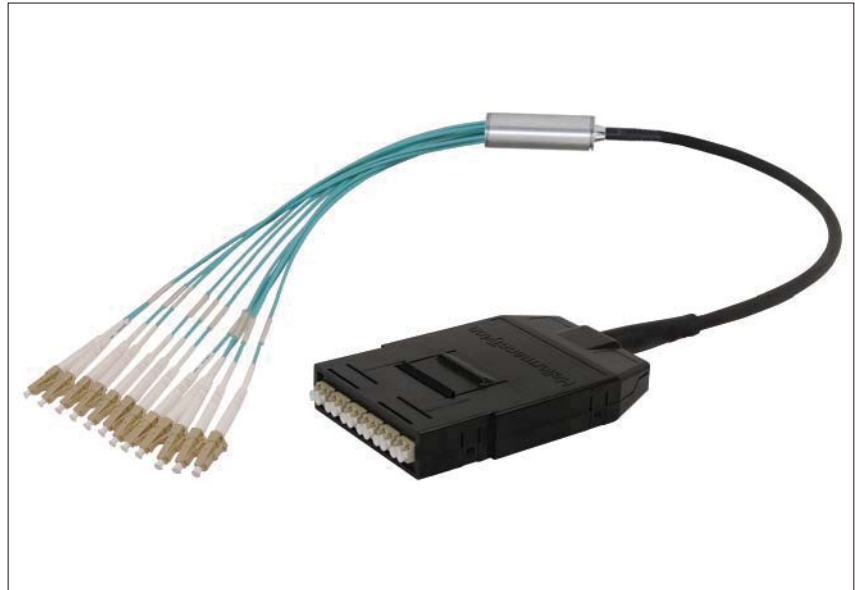

The 12 core LC Cassette to LC Fan Out ideal for connectivity with active hardware

Product Description

The RapidNet Fibre Cassette is pre-terminated offering LC connectivity in either single mode or multimode.

Each 12 port cassette fits into the RapidNet Panel, which accepts 4 cassettes in 1U of space, achieving a maximum of 48 fibre ports in 1U.

RapidNet Fibre Cassettes are pre-terminated and pre-tested, installation time can be reduced by up to 85% and virtually eliminating the risk of dust and dirt affecting the connectivity and overall performance.

Technical Data Table

Article-No.	Type	Performance Category	Height (H)	Width (W)	Depth (D)	Length (L)	Port count
859-20799	RNFTD12-LCLFM3-10.0M	OM3 Multimode	27.0	102.0	130.0	10.0 m	12
859-21655	RNFTD-12LCLFM4-10.0M	OM4 Multimode	27.0	102.0	130.0	10.0 m	12
859-21255	RNFTD12-LCLFS1-10.0M	OS1 Single Mode	27.0	102.0	130.0	10.0 m	12

All dimensions in mm. Subject to technical changes.

Technical Description

The RapidNet Fibre LC Cassette offers 12 ports using pre-terminated OM3, OM4 or OS1 fibre cable.

The fibre is pre-terminated in a clean factory environment and all terminations are pre-tested before the product is sent to our customers. The fibre cable is secured and protected by a rubber boot on entry into the cassette. The fibre is then separated using a splitter unit with the LC fan outs presented to specified lengths.

NB. Part Number is given for a 10m loom as an example. Other lengths are available on request that meet the maximum distance performances defined in ISO/IEC 11801-2 and TIA/ANSI 568-C.2. The standard fan out breakout length is 0.5m for loom lengths between 2m to 5m and 1m for loom lengths over 5m.

Technical Drawings

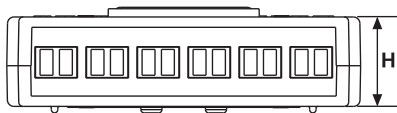

Front View of the 12 port LC RapidNet Fibre Cassette

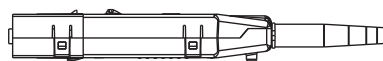

Side View of the 12 port LC RapidNet Fibre Cassette

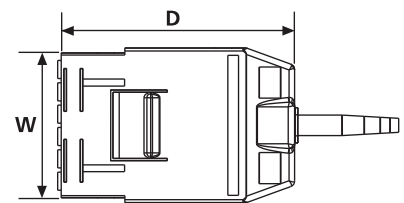

Top View of the 12 port LC RapidNet Fibre Cassette



RapidNet Fibre LC 12 Core Cassette to SC Fan Out

Features and Benefits

- Up to 48 fibres in 1U of Space
- Significantly reduced installation times
- Available in OM3, OM4 and OS1
- Dual labelling fields
- Interchangeable with other RapidNet Cassettes
- SC fan out enables inter-connectivity with active hardware
- Pre-tested with test results supplied



The 12 core LC Cassette to SC Fan Out ideal for connectivity with active hardware

Product Description

The RapidNet Fibre Cassette is pre-terminated offering LC connectivity in either single mode or multimode.

Each 12 port cassette fits into the RapidNet Panel, which accepts 4 cassettes in 1U of space, achieving a maximum of 48 fibre ports in 1U.

RapidNet Fibre Cassettes are pre-terminated and pre-tested, installation time can be reduced by up to 85% and virtually eliminating the risk of dust and dirt affecting the connectivity and overall performance.

Technical Data Table

Article-No.	Type	Performance Category	Height (H)	Width (W)	Depth (D)	Length (L)	Port count
859-21658	RNFTD-12LCSFM3-10.0M	OM3 Multimode	27.0	102.0	130.0	10.0 m	12
859-21659	RNFTD-12LCSFM4-10.0M	OM4 Multimode	27.0	102.0	130.0	10.0 m	12
859-21657	RNFTD-12LCSFS1-10.0M	OS1 Single Mode	27.0	102.0	130.0	10.0 m	12

All dimensions in mm. Subject to technical changes.

Technical Description

The RapidNet Fibre LC Cassette offers 12 ports using pre-terminated OM3, OM4 or OS1 fibre cable.

The fibre is pre-terminated in a clean factory environment and all terminations are pre-tested before the product is sent to our customers. The fibre cable is secured and protected by a rubber boot on entry into the cassette. The fibre is then separated using a splitter unit with the SC fan outs presented to specified lengths.

NB. Part Number is given for a 10m loom as an example. Other lengths are available on request that meet the maximum distance performances defined in ISO/IEC 11801-2 and TIA/ANSI 568-C.2. The standard fan out breakout length is 0.5m for loom lengths between 2m to 5m and 1m for loom lengths over 5m.

Technical Drawings

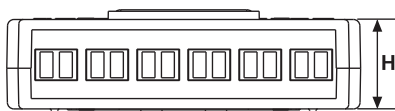

Front View of the 12 port LC
RapidNet Fibre Cassette

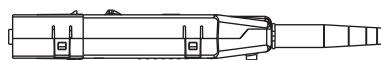

Side View of the 12 port LC
RapidNet Fibre Cassette

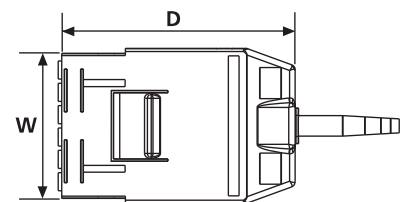

Top View of the 12 port LC
RapidNet Fibre Cassette



RapidNet Fibre SC 12 Core Cassette to Cassette

Features and Benefits

- Up to 48 fibres in 1U of Space
- Significantly reduced installation times
- Available in OM3, OM4 and OS1
- Dual labelling fields
- Interchangeable with other RapidNet Cassettes
- Pre-tested with test results supplied



The 12 port SC Cassette to Cassette is available in OM3, OM4 and OS1

Product Description

The RapidNet Fibre Cassette is pre-terminated offering SC connectivity in either single mode or multimode.

Each 12 port cassette fits into the RapidNet Panel, which accepts 4 cassettes in 1U of space, achieving a maximum of 48 fibre ports in 1U.

RapidNet Fibre Cassettes are pre-terminated and pre-tested, installation time can be reduced by up to 85% and virtually eliminating the risk of dust and dirt affecting the connectivity and overall performance.

Technical Data Table

Article-No.	Type	Performance Category	Height (H)	Width (W)	Depth (D)	Length (L)	Port count
859-20917	RNFTD-12SCSCM3-10.0M	OM3 Multimode	27.0	102.0	130.0	10.0 m	12
859-21669	RNFTD-12SCSCM4-10.0M	OM4 Multimode	27.0	102.0	130.0	10.0 m	12
859-20639	RNFTD-12SCSCS1-10.0M	OS1 Single Mode	27.0	102.0	130.0	10.0 m	12

All dimensions in mm. Subject to technical changes.

Technical Description

The RapidNet Fibre SC Cassette offers 12 (6 duplex) ports using pre-terminated OM3, OM4 or OS1 fibre cable.

The fibre is pre-terminated in a clean factory environment and all terminations are pre-tested before the product is sent to our customers. The fibre cable is secured and protected by a rubber boot on entry into the cassette.

NB. Part Number is given for a 10m loom as an example. Other lengths are available on request that meet the maximum distance performances defined in ISO/IEC 11801-2 and TIA/ANSI 568-C.2.

Technical Drawings

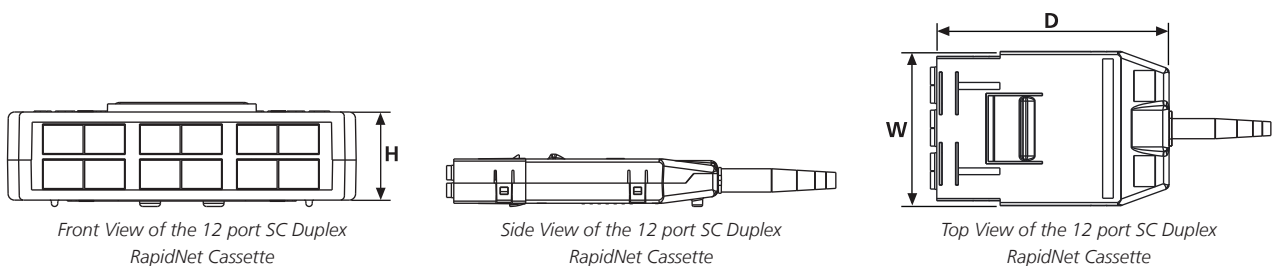



RapidNet Fibre SC 12 Core Cassette with 1 Rear MTP Connectivity

Features and Benefits

- Up to 48 fibres in 1U of Space
- Significantly reduced installation times
- Available in OM3, OM4 and OS1
- Dual labelling fields
- Interchangeable with other RapidNet Cassettes
- MTP rear connector ideal for installations in areas of limited space
- Pre-tested with test results supplied



12 Port SC Duplex RapidNet Cassette with MTP Connector

Product Description

The RapidNet Fibre Cassette is pre-terminated offering SC connectivity in either single mode or multimode.

Each 12 port cassette fits into the RapidNet Panel, which accepts 4 cassettes in 1U of space, achieving a maximum of 48 fibre ports in 1U.

RapidNet Fibre Cassettes are pre-terminated and pre-tested, installation time can be reduced by up to 85% and virtually eliminating the risk of dust and dirt affecting the connectivity and overall performance.

Technical Data Table

Article-No.	Type	Performance Category	Height (H)	Width (W)	Depth (D)	Port count
859-21673	RNFTD-12SCMMM3-XX.XX	OM3 Multimode	27.0	102.0	130.0	12
859-21674	RNFTD-12SCMMM4-XX.XX	OM4 Multimode	27.0	102.0	130.0	12
859-21672	RNFTD-12SCMMS1-XX.XX	OS1 Single Mode	27.0	102.0	130.0	12

All dimensions in mm. Subject to technical changes.

Technical Description

The RapidNet Fibre SC Cassette offers 12 ports (6 duplex) using pre-terminated OM3, OM4 or OS1 fibre cable.

The fibre is pre-terminated in a clean factory environment and all terminations are pre-tested before the product is sent to our customers. The fibre cassette has a single 12 core MTP connector on the rear for use with MTP back bone cables or fan outs.

Technical Drawings



Front View of 12 Port SC Duplex Cassette



Side View of 12 Port SC Duplex Cassette

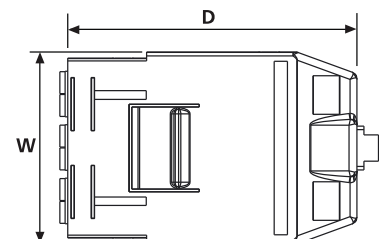

Top View of 12 Port SC Duplex Cassette



RapidNet Fibre SC 12 Core Cassette to SC Fan Out

Features and Benefits

- Up to 48 fibres in 1U of Space
- Significantly reduced installation times
- Available in OM3, OM4 and OS1
- Dual labelling fields
- Interchangeable with other RapidNet Cassettes
- SC fan out enables inter-connectivity with active hardware
- Pre-tested with test results supplied

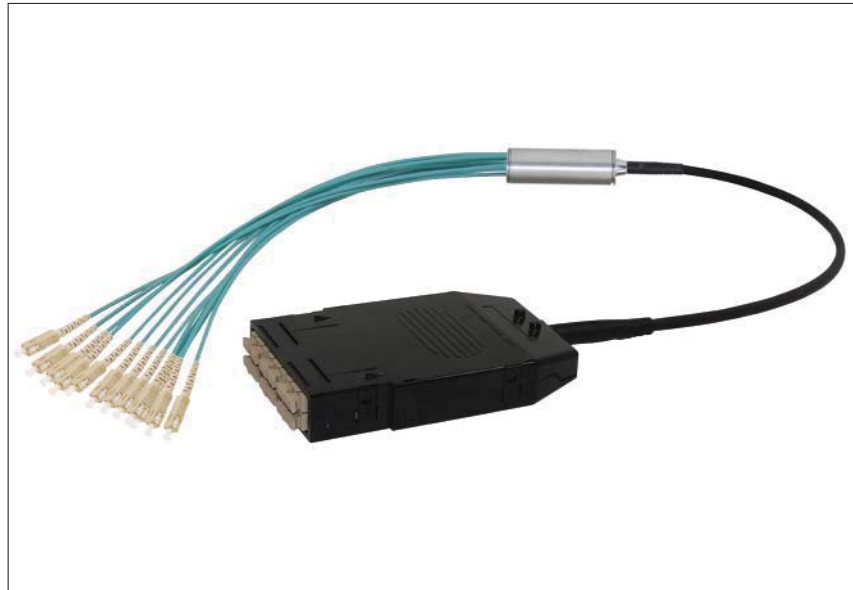

The 12 core SC Cassette to SC Fan Out is ideal for connectivity with active hardware

Product Description

The RapidNet Fibre Cassette is pre-terminated offering SC connectivity in either single mode or multimode.

Each 12 port cassette fits into the RapidNet Panel, which accepts 4 cassettes in 1U of space, achieving a maximum of 48 fibre ports in 1U.

RapidNet Fibre cassettes are pre-terminated and pre-tested, installation time can be reduced by up to 85% and virtually eliminating the risk of dust and dirt affecting the connectivity and overall performance.

Technical Data Table

Article-No.	Type	Performance Category	Height (H)	Width (W)	Depth (D)	Length (L)	Port count
859-21253	RNFTD-12SCSFM3-10.0M	OM3 Multimode	27.0	102.0	130.0	10.0 m	12
859-21671	RNFTD-12SCSFM4-10.0M	OM4 Multimode	27.0	102.0	130.0	10.0 m	12
859-21670	RNFTD-12SCSFS1-10.0M	OS1 Single Mode	27.0	102.0	130.0	10.0 m	12

All dimensions in mm. Subject to technical changes.

Technical Description

The RapidNet Fibre SC Cassette offers 12 ports (6 duplex) using pre-terminated OM3, OM4 or OS1 fibre cable.

The fibre is pre-terminated in a clean factory environment and all terminations are pre-tested before the product is sent to our customers. The fibre cable is secured and protected by a rubber boot on entry into the cassette. The fibre is then separated using a splitter unit with the SC fan outs presented to specified lengths.

NB. Part Number is given for a 10m loom as an example. Other lengths are available on request that meet the maximum distance performances defined in ISO/IEC 11801-2 and TIA/ANSI 568-C.2. The standard fan out breakout length is 0.5m for loom lengths between 2m to 5m and 1m for loom lengths over 5m.

Technical Drawings

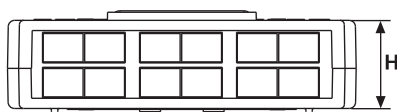

Front View of the 12 port SC Duplex RapidNet Cassette



Side View of the 12 port SC Duplex RapidNet Cassette

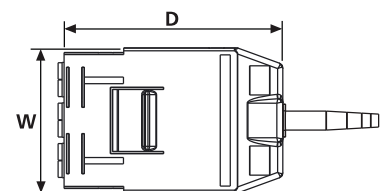

Top View of the 12 port SC Duplex RapidNet Cassette



RapidNet Accessories

12 Port Cassette Panel

Features and Benefits

- Fits all 19" racks, frames and cabinets
- Supplied with Rack Snaps as standard or cage nuts
- Simple, easy insertion with push down clip
- Accommodates 4 cassettes presenting 48 RJ45 ports
- Labelling software with Alpha Label

Product Description

The 12 Port RapidNet Patch Panel accommodates four 12 port copper cassettes. The 12 port panel offers labelling fields on the actual cassette itself.

The RapidNet Cassettes simply push into the panels, snapping in with a push down clip. A fully loaded panel presents 48 Category 6 or Category 5e RJ45 ports.



The 12 Port RapidNet Panel holds 4 12 port Cassettes

Technical Data Table

Article-No.	Type	Height (H)	Width (W)	Depth (D)	Port count	Colour
859-30045	RNADUXX-PA1UCN-XX.XX	44.0	484.0	72.0	48	Black (BK)
859-30033	RNADUXX-PA1URS-XX.XX	44.0	484.0	72.0	48	Black (BK)

All dimensions in mm. Subject to technical changes.

Technical Description

The RapidNet Patch Panel frame is manufactured to the standard 19" width and is available in 1U option.

The panels are available separately and are supplied with Rack Snaps as standard or with cage nuts.

The 12 port Cassette labelling can be customised using Alpha Label software available at www.htdata.co.uk

RapidNet Accessories

6 Port Copper/Fibre Cassette Panel

Features and Benefits

- Fits all 19" racks, frames and cabinets
- Supplied with Rack Snaps as standard or cage nuts
- Simple, easy insertion with push down clip
- Accommodates 4 Category 6, Category 5e or fibre cassettes
- Dual labelling fields and labelling software with Alpha Label

Product Description

The RapidNet Patch Panel accommodates four Category 6 or Category 5e copper cassettes and the full range of MTP, LC and SC fibre cassettes.

The RapidNet Cassettes simply push into the panels, snapping in with a push down clip. The RapidNet Panel comes with dual, magnified labelling fields.



This RapidNet Panel holds 4 copper or fibre cassettes

Technical Data Table

Article-No.	Type	Height (H)	Width (W)	Depth (D)	Colour
859-30022	RNA6UXX-PA1UCN-XX.XX	44.0	483.0	56.0	Black (BK)
859-30019	RNA6UXX-PA1URS-XX.XX	44.0	483.0	56.0	Black (BK)

All dimensions in mm. Subject to technical changes.

Technical Description

The RapidNet Patch Panel frame is manufactured to the standard 19" width and is available in 1U option.

The panels are available separately and are supplied with Rack Snap as standard or with cage nuts.

The panels have dual magnifying lens with customised labelling available through Alpha Label software at www.htdata.co.uk



RapidNet Accessories

6 Port Cassette Shielded Panel

Features and Benefits

- Fits all 19" racks, frames and cabinets
- Supplied with Rack Snaps as standard or cage nuts
- Simple, easy insertion with push down clip
- Accommodates 4 shielded Category 6A, Category 6 or Category 5e cassettes
- Dual labeling fields and labelling software with Alpha Label

Product Description

The RapidNet Patch Panel accommodates four shielded Category 6A, Category 6 or Category 5e copper cassettes. The shielded panel is constructed with a metal shielding plate with three earthing anchor points.

The RapidNet Cassettes simply push into the panels, snapping in with a push down clip. The RapidNet Panel comes with dual, magnified labelling fields.



The shielded RapidNet Panel has an earthing bar and 3 earthing points

Technical Data Table

Article-No.	Type	Height (H)	Width (W)	Depth (D)	Colour
859-50852	RNA6G6A-PA1UCN-XX.XX	44.0	483.0	71.0	Black (BK)
859-50851	RNA6G6A-PA1URS-XX.XX	44.0	483.0	71.0	Black (BK)

All dimensions in mm. Subject to technical changes.

Technical Description

The RapidNet Patch Panel frame is manufactured to the standard 19" width and is available in 1U option.

The panels are available separately and are supplied with Rack Snap as standard or with cage nuts.

The panels have dual magnifying lens with customised labelling available through Alpha Label software at www.htdata.co.uk

RapidNet Accessories

4 Port Cassette Panel

Features and Benefits

- Fits all 19" racks, frames and cabinets
- Supplied with Rack Snaps
- Simple, easy insertion with push down clip
- Accommodates 6 Category 6 or Category 5e cassettes
- Dual labeling fields and labelling software with Alpha Label

Product Description

The RapidNet Patch Panel accommodates six 4 port Category 6 or Category 5e copper cassettes.

The RapidNet Cassettes simply push into the panels, snapping in with a push down clip. The RapidNet Panel comes with dual, magnified labelling fields.



Can hold six 4-Port RapidNet Cassettes and comes with dual labelling fields

Technical Data Table

Article-No.	Type	Height (H)	Width (W)	Depth (D)	Colour
859-30013	RN04-2408-UL	44.0	484.0	38.0	Black (BK)

All dimensions in mm. Subject to technical changes.

Technical Description

The RapidNet Patch Panel frame is manufactured to the standard 19" width and is available in 1U option.

The panels are available separately and are supplied with Rack Snap as standard.

The panels have dual magnifying lens with customised labelling available through Alpha Label software at www.htdata.co.uk



RapidNet Accessories

Rear Cable Management Panel

Features and Benefits

- Accommodates 4 standard RapidNet Cassettes
- Dual label fields with magnifying lenses
- Supported rear cables
- Multiple cable fixing locations
- Multiple rear entry points
- Vertical cable protection

Product Description

HellermannTyton's RapidNet Panel with rear cable management provides support and protection for MTP backbone and fibre cables within a cabinet or patching frame.

The panel can also be used with the RapidNet direct terminated fibre solution, RapidNet MTP VHD or UTP copper RapidNet Cassettes, providing additional rear cable management and enabling a 'mix and match' approach between copper and fibre.



The RapidNet Rear Management Panel offers support and protection to cables

Technical Data Table

Article-No.	Type	Height (H)	Width (W)	Depth (D)	Colour
859-30048	RNA6UXX-PB1UCN-XX.XX	44.0	483.0	289.0	Black (BK)
859-30047	RNA6UXX-PB1URS-XX.XX	44.0	483.0	289.0	Black (BK)

All dimensions in mm. Subject to technical changes.

Technical Description

A range of fixing points are provided in the rear of the panel to secure cables and provide strain relief for the MTP connectors and adapters. 25mm conduit (available as kits) then supports and

protects the cables from the panel to the horizontal cable routes. Multiple rear entry points are provided for the conduit tubing to enable maximum flexibility.

RapidNet Accessories

Hybrid Panel

Features and Benefits

- Helps save rack space
- Offers both fibre and copper in 1U
- Up to 24 ports using 12 port RapidNet
- Up to 288 fibres using RapidNet MTP VHD
- Typical configuration of 24 fibre and 24 copper ports
- Label fields for identification of all ports

Product Description

The 1U RapidNet Hybrid Panel provides a simple 'Mix and Match' approach for both copper and fibre RapidNet. The panel offers capacity for the equivalent of 1U of fibre and 1U of copper in 1U of rack space, giving a saving of 1U of space each time the panel is used.



The Hybrid RapidNet Panel provides copper and fibre connectivity in 1U

Technical Data Table

Article-No.	Type	Height (H)	Width (W)	Depth (D)	Colour
859-30049	RNAHUX-PA1UCN-HH.SS	44.0	483.0	72.0	Black (BK)
859-30050	RNAHUX-PA1UCN-HS.HS	44.0	483.0	72.0	Black (BK)
859-30042	RNAHUX-PA1URS-HH.SS	44.0	483.0	72.0	Black (BK)
859-30043	RNAHUX-PA1URS-HS.HS	44.0	483.0	72.0	Black (BK)

All dimensions in mm. Subject to technical changes

Technical Description

The panels allow for a combination of 12 port high density copper RapidNet and 12 or 24 core fibre (direct terminated or MTP) or high

density copper and RapidNet MTP VHD for up to 288 fibres. There are two configurations available.



RapidNet Accessories
Category 6 RapidNet Clips

Features and Benefits

- Clips to any standard 50mm mesh
- Each clip accommodates 4 Category 6 RapidNet Looms
- Provides effective cable management in cabinets and wire cable trays
- Helps maintain bend radius for optimum performance
- Can link up to additional RapidNet Clips

Product Description

The RapidNet Clips push onto standard 50mm mesh kits with a sliding cover (available separately - RNCCC) to help secure the cable looms.

The clips hold up to 4 RapidNet Cable Looms into selected position inside comms cabinets or on cable management trays.



The RapidNet Clip can hold up to four Category 6 or Category 5e RapidNet looms

Technical Data Table

Article-No.	Type	Performance Category	Height (H)	Width (W)	Depth (D)	Colour
859-35000	RNCC6	Category 6 (Class E)	45.0	59.0	60.0	Black (BK)
859-35001	RNCCC	Category 6 (Class E)	43.0	55.0	2.0	Black (BK)

All dimensions in mm. Subject to technical changes.

Technical Description

The RapidNet Cable Clip has been designed to help maintain effective and tidy cable management within the cabinet.

The clip also offers cable strain relief supporting the weight of the RapidNet Cable Loom.

RapidNet Accessories
Category 5e RapidNet Clips

Features and Benefits

- Clips to any standard 50mm mesh
- Each clip accommodates 4 Category 5e RapidNet looms
- Provides effective cable management in cabinets and wire cable trays
- Helps maintain bend radius for optimum performance
- Can link up to additional RapidNet Clips

Product Description

The RapidNet Clips push onto standard 50mm mesh kits with a sliding cover (available separately - RNCCC) to help secure the cable looms.

The clips hold up to 4 RapidNet Cable Looms into selected position inside comms cabinets or on cable management trays.



The RapidNet Clip can hold up to four Category 6 or Category 5e RapidNet Looms

Technical Data Table

Article-No.	Type	Performance Category	Height (H)	Width (W)	Depth (D)	Colour
859-10001	RNCC5	Category 5E (Class D)	45.0	59.0	60.0	Black (BK)
859-35001	RNCCC	Category 5E (Class D)	43.0	55.0	2.0	Black (BK)

All dimensions in mm. Subject to technical changes.

Technical Description

The RapidNet Cable Clip has been designed to help maintain effective and tidy cable management within the cabinet.

The clip also offers cable strain relief supporting the weight of the RapidNet Cable Loom.



RapidNet Accessories

RapidNet Blanks

Features and Benefits

- Plastic blank for partially loaded panels
- 12 port, 6 port/fibre and 4 port blanks

Product Description

The RapidNet Blanks are available in 3 sizes; 12 port high density cassette, 6 port/fibre cassette and 4 port cassette sizes.

The blanks are designed to fill partially loaded RapidNet Panels.



Available as 12 port, 6 port/fibre and 4 port blanks.

Technical Data Table

Article-No.	Type	Height (H)	Width (W)	Depth (D)	Port count	Colour
851-40196	RN BLANK	27.0	102.0	66.0	6	Black (BK)
859-35134	RN04-BLANK	22.0	69.0	47.0	4	Black (BK)
854-40266	RNAD-BLANK	41.0	102.0	66.0	12	Black (BK)

All dimensions in mm. Subject to technical changes

Technical Description

The RapidNet Blanks have a push down clip that fits into the different RapidNet Panels available:

12 Port Blank (RNAD-BLANK) - RNADUXX-PA1URS-XX.XX, RNADUXX-PA1UCN-XX.XX

6 Port Blank (RN-BLANK) - RNA6UXX-PA1URS-XX.XX, RNA6UXX-PA1UCN-XX.XX,

RNA6G6A-PA1UXX-XX.XX, RNA6G6A-PA1UCN-XX.XX

4 Port Blank (RN04-BLANK) - RN04-2408-UL

RapidNet Blanks can also be used with RapidNet Rear Management Panels, RapidNet Hybrid Panels and the Out of Rack solution.

RapidNet Accessories

RapidNet Floor Boxes

Features and Benefits

- Holds 1-3 cassettes
- Can be used under the floor
- Can be secured to the floor via several fixing points
- Double labelling fields

Product Description

The RapidNet Floor Box is designed to house the RapidNet Cassette away from the comms cabinet and provides a good 'to the desk' solution.

Available in both triple and single versions, the RapidNet Floor Box can take up to three RapidNet Cassettes.



Available as a single or triple RapidNet Floor Box

Technical Data Table

Article-No.	Type	Height (H)	Width (W)	Depth (D)	Colour
859-35050	RNSFB-1	53.0	183.0	200.0	Black (BK)
859-35064	RNSFB-3	53.0	435.0	301.0	Black (BK)

All dimensions in mm. Subject to technical changes.

Technical Description

The RapidNet Floor Box can be fixed to the floor or under the floor using several fixing points.

The RapidNet Floor Box is manufactured from powder coated mild steel and has dual magnified labelling fields for easy port identification.



RapidNet Accessories

RapidNet Mesh

Features and Benefits

- For use in cabinets
- Works in conjunction with RapidNet Cable Management Clips
- Up to 47U high
- 300mm deep
- 50mm squares
- Bright zinc finish

Product Description

RapidNet Mesh can be fixed into the sides of comms cabinets to act as an anchor point for cable using RapidNet Clips.

The clips are designed to fit on the 50mm squares of the RapidNet Mesh.

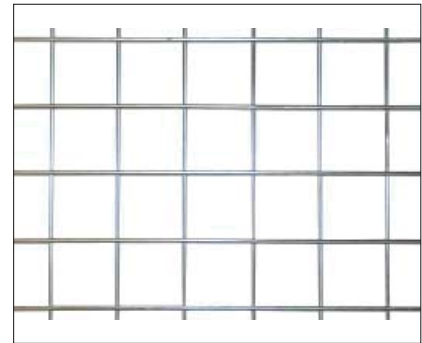

The RapidNet Mesh works in conjunction with the RapidNet Clips

Technical Data Table

Article-No.	Type	Height (H)	Width (W)
859-35007	RN-MESH Kit	2000.0	300.0

All dimensions in mm. Subject to technical changes.

Technical Description

The mesh is manufactured from strong steel with a stainless zinc finish. The mesh can be cut to size depending on the size of the cabinet or space being used.

RapidNet Accessories

RapidNet Trolley

Features and Benefits

- Cable pulling made easier
- Can hold up to 4 looms
- Lockable castors
- Pre-assembled 'A' frame

Product Description

The RapidNet Trolley can hold up to 4 RapidNet Drums/Looms allowing for all four looms to be pulled through easily in one go.

The trolley helps speed up any RapidNet installation.



The RapidNet Trolley can hold up to 4 RapidNet drums

Technical Data Table

Article-No.	Type	Height (H)	Width (W)	Depth (D)
859-35027	TR001-V2	1205.0	686.0	1084.0

All dimensions in mm. Subject to technical changes.

Technical Description

The RapidNet Trolley is constructed from sturdy steel with a black powder coated finish. The trolley has 4 quality castors, 2 of which are lockable.

Pre-terminated Data Centre Solutions

RapidNet

- World leading pre-terminated system
- Faster investment to revenue stream
- Supports 10G systems in copper
- 40G and 100G ready with MTP VHD fibre
- High density, space saving fibre and copper versions available
- Wide range of mounting options
- Less waste, UK Manufactured - Reduced Carbon Footprint





2 Patch Panels

	Page
2.1 Category 6A Panels	
Deca¹⁰ Category 6A	
1U 24 Port Panel	70
1U 24 Port Sliding Panel	71
2.2 Category 6 Panels	
GigaBand Category 6	
2U 48 Port Panel	72
1U 24 Port Panel	73
Global Category 6	
2U 48 Port Panel	74
1U 24 Port Panel	75
EcoBand Category 6	
1U 48 Port Panel	76
1U 24 Port Right Angled Panel	77
EcoBand Shielded Category 6	
1U 24 Port Panel	78
Universal 110 Category 6	
2U 48 Port Panel	79
1U 24 Port Panel	80
1U 48 Port Panel	81
Vertical 12 Port Panel	82

	Page
2.3 Category 5e Panels	
Alpha Snap Category 5e	
2U 48 Port Panel	83
1U 24 Port Panel	84
1U 24 Port Jack to Jack Panel	85
Global Category 5e	
2U 48 Port Panel	88
1U 24 Port Panel	89
MegaBand Category 5e	
2U 48 Port Panel	88
1U 24 Port Panel	89
EcoBand Shielded Category 5e	
1U 48 Port Panel	90
EcoBand Category 5e	
1U 48 Port Panel	91
1U 24 Port Panel	92
Universal 110 Category 5e	
2U 48 Port Panel	93
1U 24 Port Panel	94
1U 48 Port Panel	95
Vertical 12 Port Panel	96
2.4 Category 3 Voice	
50 Port Panel	97
25 Port Panel	98



Deca¹⁰ Category 6A 1U 24 Port Panel

Features and Benefits

- 24 Category 6A ports in 1U
- Exceeds Category 6A performance standards
- Dual labelling fields
- Uncompromised support for 10G
- 360° shielding eliminates alien crosstalk
- Available as either sliding or fixed panels

6A



Deca¹⁰ Category 6A 24 port Panel

Product Description

The Deca¹⁰ Keystone Patch Panel is designed to accommodate the Deca¹⁰ Keystone Jack ensuring that the shielded system is maintained. The panel features a choice of ground stud positions on the integral grounding bar and includes rear cable management.

The patch panel accepts 24 separate Category 6A Keystone Jacks in 1U of space offering 24 RJ45 ports.

Technical Data Table

Article-No.	Type	Performance Category	Height (H)	Width (W)	Depth (D)	Port count
853-55000	PP24G6A-PA1URS-FD.XX	Category 6A (Class EA)	44.0	483.0	85.0	24

All dimensions in mm. Subject to technical changes.

Technical Description

The Deca¹⁰ copper solution is designed using U-FTP Category 6A cable which provides 360° shielding and eliminates alien crosstalk.

The Deca¹⁰ Category 6A Panel accommodates 24 Category 6A Keystone Jacks 1U.

The integral earthing plate grounds each Keystone Jack helping to guarantee 10G performance by giving continuity of the 360° shielding.

Tested to exceed ISO/EIA 11801:2002 and ANSI/TIA/EIA 568 - C.2 standards, the Deca¹⁰ Category 6A Panel offers backward compatibility with Category 6, Category 5e, Category 5 and voice products.

Technical Drawings



Front view of 1U 24 port Deca¹⁰ Category 6A Panel

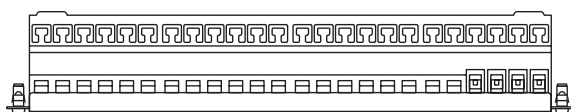

Top view of 1U 24 port Deca¹⁰ Category 6A Panel

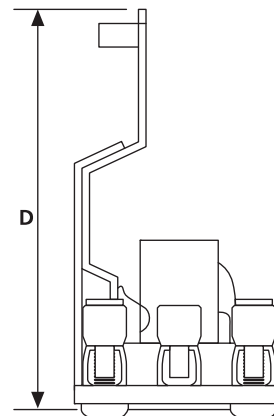

Side view of 1U 24 port Deca¹⁰ Category 6A Panel



Deca¹⁰ Category 6A 24 Port Sliding Panel

Features and Benefits

- 24 Category 6A ports in 1U
- Exceeds Category 6A performance standards
- Sliding panel allows front access to terminated keystones
- Dual labelling fields
- Uncompromised support for 10G
- 360° shielding eliminates alien crosstalk



Deca¹⁰ Sliding Panel allows access to terminations from the front of the panel

Product Description

The Deca¹⁰ Keystone Patch Panel is designed to accommodate the Deca¹⁰ Keystone Jack ensuring that the shielded system is maintained. The panel features a choice of ground stud positions on the integral grounding bar and includes rear cable management.

The slide out design allows access to the terminations from the front of the panel.

The patch panel accepts 24 separate Category 6A Keystone Jacks in 1U of space offering 24 RJ45 ports.

Technical Data Table

Article-No.	Type	Performance Category	Height (H)	Width (W)	Depth (D)	Port count
853-55001	PP24G6A-PA1URS-SL.XX	Category 6A (Class EA)	44.0	483.0	192.0	24

All dimensions in mm. Subject to technical changes.

Technical Description

The Deca¹⁰ copper solution is designed using U-FTP Category 6A cable which provides 360° shielding and eliminates alien crosstalk.

The Deca¹⁰ Category 6A Panel accommodates 24 Category 6A Keystone Jacks 1U.

The integral earthing plate grounds each Keystone Jack helping to guarantee 10G performance by giving continuity of the 360° shielding.

Tested to exceed ISO/EIA 11801:2002 and ANSI/TIA/EIA 568 - C.2 standards, the Deca¹⁰ Category 6A Panel offers backward compatibility with Category 6, Category 5e, Category 5 and voice products.

Technical Drawings



Front view of Deca¹⁰ Category 6A Sliding Panel

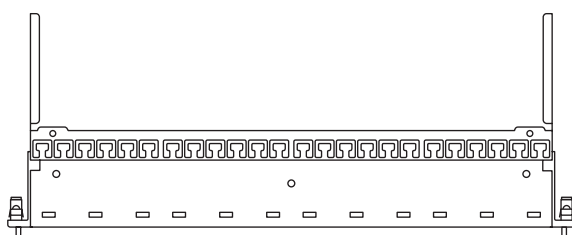

Top view of Deca¹⁰ Category 6A Sliding Panel

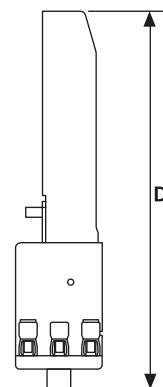

Side view of Deca¹⁰ Category 6A Sliding Panel



GigaBand Category 6 2U 48 Port Panel

Features and Benefits

- Exceeds Category 6 performance standards
- All modules are individually removable and replaceable
- Supplied with Rack Snap mounting fixings
- Includes aluminium rear cable management as standard
- Patented slide label system and software available
- 568A or 568B wiring options
- Backward compatible with Category 5e, Category 5 and Voice

6



High Density Category 6 GigaBand Patch Panel presenting 48 ports in 2U

Product Description

GigaBand is the premium Category 6 range from HellermannTyton. Designed to offer exceptional Category 6 performance and to meet the exacting standards of mission critical installations. The patch panel comprises individual modular PCB's giving ultimate flexibility in the case of port damage or failure.

The GigaBand Panel incorporates HellermannTyton's patented sliding label system enabling clear and effective port identification.

The GigaBand Panel is available in 1U 24 port and 2U 48 port versions and is supplied with HellermannTyton's unique aluminium snap-on rear cable manager and Rack Snap mounting fixings as standard.

Technical Data Table

Article-No.	Type	Performance Category	Height (H)	Width (W)	Depth (D)	Port count
853-40107	2/4808IDCNGBHDCM/BK	Category 6 (Class E)	88.0	483.0	134.0	48

All dimensions in mm. Subject to technical changes.

Technical Description

GigaBand Category 6 Patch Panels are available in 1U 24 port and 2U 48 ports configurations.

Each of the individual PCB modules are mounted in the unique Alpha Snap plastic moulding which is attached to the front of the panel.

Each PCB module is equipped with a cable retention bar and the end modules of each horizontal row are colour coded and numbered for error free termination.

The Alpha Label software package, available for download at www.htdata.co.uk enables straightforward port labelling.

Technical Drawings

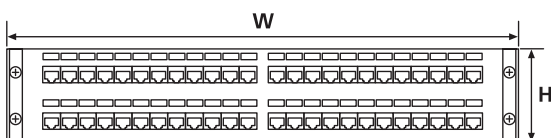

Front view of Category 6 2U 48 port GigaBand Panel

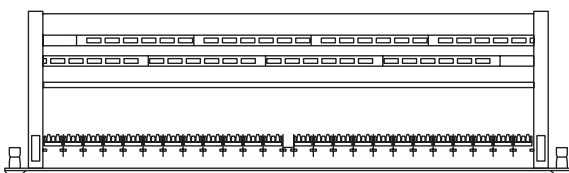

Top view of Category 6 2U 48 port GigaBand Panel

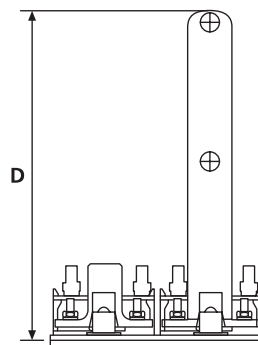

Side view of Category 6 2U 48 port GigaBand Panel



GigaBand Category 6 1U 24 Port Panel

Features and Benefits

- Exceeds Category 6 performance standards
- All modules are individually removable and replaceable
- Supplied with Rack Snap mounting fixings
- Includes aluminium rear cable management as standard
- Patented slide label system and software available
- 568A or 568B wiring options
- Backward compatible with Category 5e, Category 5 and Voice

6



Category 6 1U 24 port GigaBand Panel

Product Description

GigaBand is the premium Category 6 range from HellermannTyton. Designed to offer exceptional Category 6 performance and to meet the exacting standards of mission critical installations. The patch panel comprises individual modular PCB's giving ultimate flexibility in the case of port damage or failure.

The GigaBand Panel incorporates HellermannTyton's patented sliding label system enabling clear and effective port identification.

The GigaBand Panel is available in 1U 24 port and 2U 48 port versions and is supplied with HellermannTyton's unique aluminium snap-on rear cable manager and Rack Snap mounting fixings as standard.

Technical Data Table

Article-No.	Type	Performance Category	Height (H)	Width (W)	Depth (D)	Port count
853-40075	1/2408IDCNGBHDCM/BK	Category 6 (Class E)	44.0	483.0	136.0	24

All dimensions in mm. Subject to technical changes.

Technical Description

GigaBand Category 6 Patch Panels are available in 1U 24 port and 2U 48 ports configurations.

Each of the individual PCB modules are mounted in the unique Alpha Snap plastic moulding which is attached to the front panel.

Each PCB module is equipped with a cable retention bar and the end modules of each horizontal row are colour coded and numbered for error free termination.

The Alpha Label software package, available for download at www.htdata.co.uk enables straightforward port labelling.

Technical Drawings



Front view of Category 6 GigaBand Panel

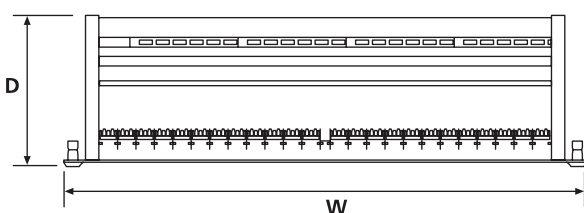

Top view of Category 6 GigaBand Panel

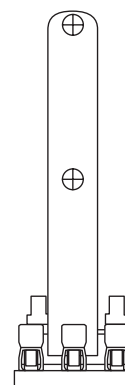

Side view of Category 6 GigaBand Panel



Global Category 6 2U 48 Port Panel

Features and Benefits

- Exceeds Category 6 performance standards
- Optional rear cable management
- 568A or 568B wiring options
- Double labelling fields and software available
- Magnifying covers over labelling fields
- 4 port RJ45 modules
- Supplied with Rack Snap mounting fixings
- Backward compatible to Category 5e, Category 5 and voice

6



2U 48 port Global Panel exceeds Category 6 performance standards

Product Description

The Global Category 6 range of patch panels offer exceptional performance and is available in 1U 24 port and 2U 48 port versions.

Each panel is constructed of 12 modular units, each offering 4 RJ45 ports. The panel can be supplied partially loaded to meet the exact requirements of the application, giving a cost effective solution.

The Global Panel is supplied with Rack Snaps mounting fixings and a rear cable manager is also available. The Global Panel offers 2 labelling fields as standard with a magnifying lens for clear identification.

Technical Data Table

Article-No.	Type	Performance Category	Height (H)	Width (W)	Depth (D)	Port count
853-45009	2/4808IDC G6/BK	Category 6 (Class E)	88.0	483.0	31.0	48

All dimensions in mm. Subject to technical changes.

Technical Description

Available in standard 1U 24 ports or 2U 48 ports, the Global Panel range offers quality, performance and value.

Tested to exceed all ISO/IEC 11801 and ANSI/TIA/EIA 568-C.2 Category 6 performance standards, the Global Patch Panel offers backward compatibility with Category 5e, Category 5 and voice products.

The jack presentation is a 4 port modular PCB assembly which can be removed and replaced if required.

The Global Panel is supplied with a comprehensive colour and numbering label on the rear modules to ensure error free terminations.

The Alpha Label software package, available for download at www.htdata.co.uk enables straightforward port labelling.

Technical Drawings

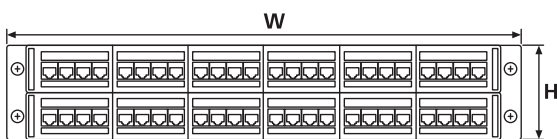

Front view of Category 6 2U 48 port Global Panel

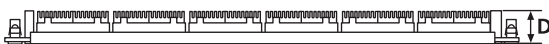

Top view of Category 6 2U 48 port Global Panel

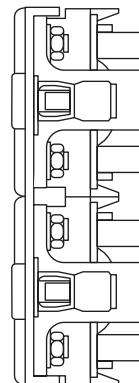

Side view of Category 6 2U 48 port Global Panel



Global Category 6 1U 24 Port Panel

Features and Benefits

- Exceeds Category 6 performance standards
- Optional rear cable management
- 568A or 568B wiring options
- Double labelling fields and software available
- Magnifying covers over labelling fields
- 4 port RJ45 modules
- Supplied with Rack Snap mounting fixings
- Backward compatible to Category 5e, Category 5 and voice

6



1U 24 port Category 6 Global Panel

Product Description

The Global Category 6 range of patch panels offer exceptional performance and is available in 1U 24 port and 2U 48 port versions.

Each panel is constructed of 6 modular units, each offering 4 RJ45 ports. The panel can be supplied partially loaded to meet the exact requirements of the application, giving a cost effective solution.

The Global Panel is supplied with Rack Snaps mounting fixings and a rear cable manager is also available. The Global Panel offers 2 labelling fields as standard with a magnifying lens for clear identification.

Technical Data Table

Article-No.	Type	Performance Category	Height (H)	Width (W)	Depth (D)	Port count
853-45004	1/2408IDC G6/BK	Category 6 (Class E)	44.0	483.0	31.0	24

All dimensions in mm. Subject to technical changes.

Technical Description

Available in standard 1U 24 ports or 2U 48 ports, the Global Panel range offers quality, performance and value.

Tested to exceed all ISO/IEC 11801 and ANSI/TIA/EIA 568-C.2 Category 6 performance standards, the Global Patch Panel offers backward compatibility with Category 5e, Category 5 and voice products.

The jack presentation is a 4 port modular PCB assembly which can be removed and replaced if required.

The Global Panel is supplied with a comprehensive colour and numbering label on the rear modules to ensure error free terminations.

The Alpha Label software package, available for download at www.htdata.co.uk enables straightforward port labelling.

Technical Drawings



Front view of Category 6 Global Panel

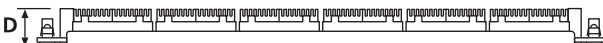

Top view of Category 6 Global Panel

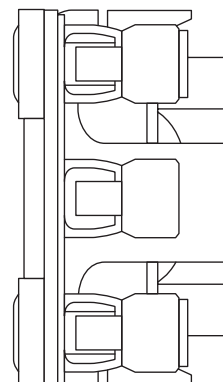

Side view of Category 6 Global Panel



EcoBand Category 6

1U 48 Port Panel

Features and Benefits

- Exceeds Category 6 performance standards
- High density panel - 48 ports in 1U
- Vertical IDC punchdown for easy termination
- Supplied with Rack Snap mounting fixings
- Integral rear cable management
- Lower layer numbered 1-24, Top layer numbered 25-48
- Backward compatible to Category 5e, Category 5 and voice

6

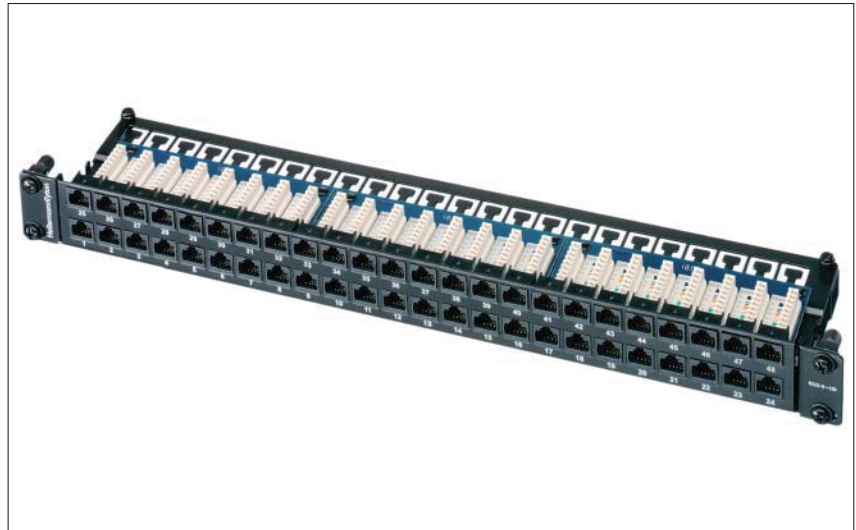

Category 6 High Density 1U 48 port EcoBand Panel

Product Description

The Category 6 EcoBand HD Panel enables high density patching presenting 48 ports in 1U and therefore saving rack space. The panel offers exceptional Category 6 performance.

The panel had been designed to support high density installations, where space is limited or is valued at a premium such as data centres and server farms.

The panel's design allows the upper row of 24 ports to be easily removed allowing access to the lower row of ports. Each row offers rear cable management providing support and protection for the cables. The vertical IDC punchdown ensures ease of installation.

Technical Data Table

Article-No.	Type	Performance Category	Heigh (H)	Width (W)	Depth (D)	Port count
853-35094	1/4808IDC C6/BK	Category 6 (Class E)	44.0	483.0	91.0	48

All dimensions in mm. Subject to technical changes.

Technical Description

The Category 6 EcoBand HD Panel presents 48 RJ45 ports in 1U of space. The ports are configured on 2 separate trays, with 24 ports on each tray. Each tray provides cable management using a standard cable tie. Individual ports are screen printed for easy identification.

Tested to exceed all ISO/IEC 11801 and ANSI/TIA/EIA 568-C.2 Category 6 performance standards, the EcoBand Patch Panel offers backward compatibility with Category 5e, Category 5 and voice products.

Technical Drawings



Front view of Category 6 1U 48 port EcoBand Panel

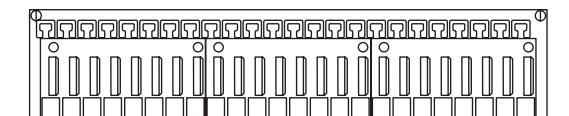

Top view of Category 6 1U 48 port EcoBand Panel

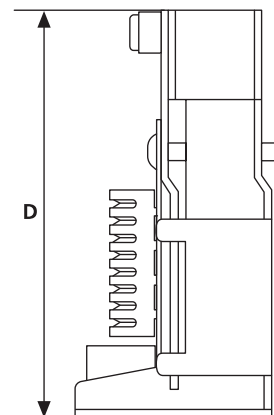

Side view of Category 6 1U 48 port EcoBand Panel



EcoBand Category 6 1U 24 Port Right Angled Panel

Features and Benefits

- Vertical IDC punch down for easy installation
- Integral rear cable management
- Exceeds Category 6 performance standards
- Range of cable the fixing positions (cable ties included)
- Slide in label mask supplied as standard
- Includes Rack Snap mounting fixings
- Backward compatible to Category 5e, Category 5 and voice

6



EcoBand 24 port Category 6 Right Angled Panel for easy installation

Product Description

The Category 6 EcoBand Panel presents 24 Category 6 RJ45 ports in 1U of space with vertical IDC punch down for ease of termination. The robust body of the panel provides integrated rear cable management with a range of cable fixing locations.

Each individual port is screen printed for easy identification with space for end user labelling with optional slide label mask.

Each panel is supplied with Rack Snap mounting fixings as standard.

Technical Data Table

Article-No.	Type	Performance Category	Height (H)	Width (W)	Depth (D)	Port count
853-50021	HT2408PB-UC6-M/BK	Category 6 (Class E)	44.0	483.0	132.0	24

All dimensions in mm. Subject to technical changes.

Technical Description

The Category 6 EcoBand Panel presents 24 Category 6 RJ45 ports in 1U of space and comes with integral rear cable management. Each individual port is screen printed for easy identification.

Tested to exceed all ISO/IEC 11801 and ANSI/TIA/EIA 568-C.2 Category 6 performance standards, the EcoBand Patch Panel offers backward compatibility with Category 5e, Category 5 and voice products.

Technical Drawings



Front view of Category 6 Right Angled EcoBand Panel

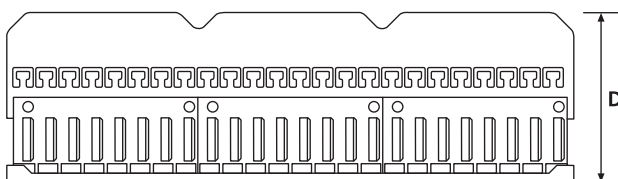

Top view of Category 6 Right Angled EcoBand Panel

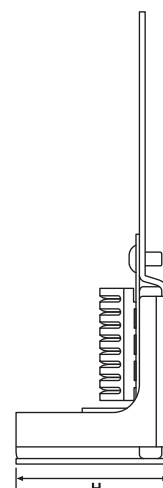

Side view of Category 6 Right Angled EcoBand Panel



EcoBand Shielded Category 6

1U 24 Port Panel

Features and Benefits

- Backward compatible to Category 5e, Category 5 and voice
- Fully shielded for optimum Category 6 performance
- Write on labelling system
- Built in rear management
- Screen printed numbering system
- Pre-assembled with rack snaps for easy installation

6



Shielded Category 6 EcoBand Panel

Product Description

The shielded Category 6 EcoBand Panel presents 24 Category 6 RJ45 ports in 1U of space with vertical IDC punch down for ease of termination. The robust body of the panel provides integrated rear cable management with a range of cable fixing locations.

Each individual port is screen printed for easy identification with space for end user labelling with the option of a slide label mask.

Each panel comes supplied with Rack Snap mounting fixings as standard.

Technical Data Table

Article-No.	Type	Performance Category	Height (H)	Width (W)	Depth (D)	Port count
853-35104	NGM2408IDC-S6/BK	Category 6 (Class E)	44.0	483.0	148.0	24

All dimensions in mm. Subject to technical changes.

Technical Description

The Category 6 EcoBand Panel presents 24 Category 6 RJ45 ports in 1U of space with integral rear cable management. Each individual port is screen printed for easy identification.

The shielded EcoBand Panel is supplied with a metallic lid to maintain the shielding throughout the system.

Tested to exceed all ISO/IEC 11801 and ANSI/TIA/EIA 568-C.2 Category 6 performance standards, the EcoBand Patch Panel offers backward compatibility with Category 5e, Category 5 and voice products.

Technical Drawings

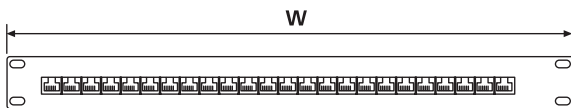

Front view of Shielded Category 6 EcoBand Panel

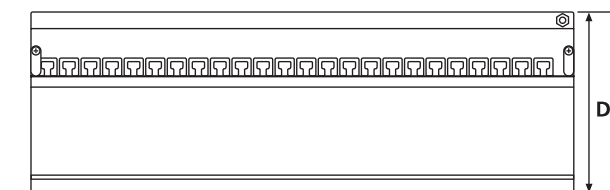

Top view of Shielded Category 6 EcoBand Panel

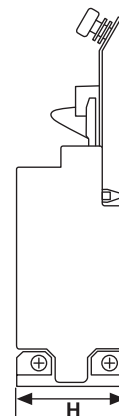

Side view of Shielded Category 6 EcoBand Panel



Universal 110 Category 6 2U 48 Port Panel

Features and Benefits

- Exceeds Category 6 performance standards
- Configured for T568A and T568B wiring
- 110 punch-down IDC
- Write-on labels provided for easy identification
- Optional rear cable manager available
- Backward compatible to Category 5e and Category 5

6

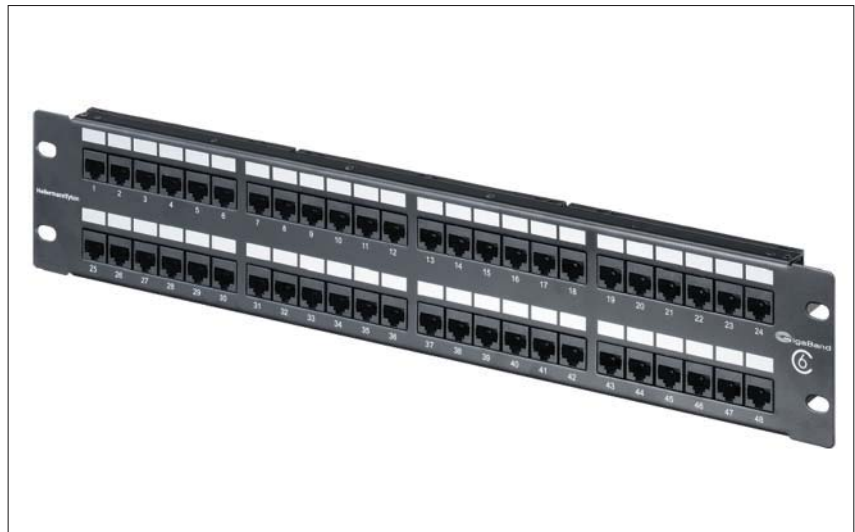

Universal 110 2U 48 port Category 6 Panel

Product Description

The Universal 110 Category 6 range of patch panels offer exceptional performance and is available in 1U 24 port and 2U 48 port versions.

Each panel is constructed of 8 modular units, each offering 6 RJ45 ports allowing for any of the 6 port modules to be replaced if damaged at any stage during installation.

The Universal Panel is supplied with Rack Snaps mounting fixings and a rear cable manager is also available. The Universal Panel offers write-on labelling fields for easy port identification.

Technical Data Table

Article-No.	Type	Performance Category	Height (H)	Width (W)	Depth (D)	Port count
853-50003	PP110C648	Category 6 (Class E)	88.0	483.0	29.0	48

All dimensions in mm. Subject to technical changes.

Technical Description

Available in standard 1U 24 ports or 2U 48 ports, the Universal Panel range offers quality, performance and value.

Tested to exceed all ISO/IEC 11801 and ANSI/TIA/EIA 568-C.2 Category 6 performance standards, the Universal Patch Panel offers backward compatibility with Category 5e, Category 5 and voice products.

The Universal Panel is supplied with a clear plastic channel which protects the PCB and allows easy viewing of wiring label. The Universal Panels are manufactured with 110 punch-down IDC blocks.

Technical Drawings

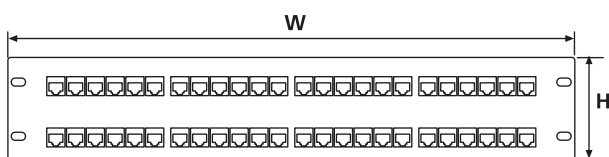

Front view of Universal 110 1U 24 port Category 6 Panel



Top view of Universal 110 1U 24 port Category 6 Panel

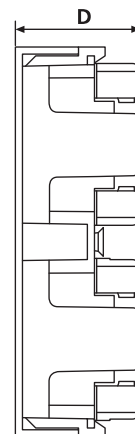

Side view of Universal 110 1U 24 port Category 6 Panel



Universal 110 Category 6 1U 24 Port Panel

Features and Benefits

- Exceeds Category 6 performance standards
- Configured for T568A and T568B wiring
- 110 punch-down IDC
- Write-on labels provided for easy identification
- Optional rear cable manager available
- Backward compatible to Category 5e and Category 5

6



Universal 110 1U 24 port Category 6 Panel

Product Description

The Universal 110 Category 6 range of patch panels offer exceptional performance and is available in 1U 24 port and 2U 48 port versions.

Each panel is constructed of 4 modular units, each offering 6 RJ45 ports allowing for any of the 6 port modules to be replaced if damaged at any stage during installation.

The Universal Panel is supplied with Rack Snaps mounting fixings and a rear cable manager is also available. The Universal Panel offers write-on labelling fields for easy port identification.

Technical Data Table

Article-No.	Type	Performance Category	Height (H)	Width (W)	Depth (D)	Port count
853-50002	PP110C624	Category 6 (Class E)	44.0	483.0	34.0	24

All dimensions in mm. Subject to technical changes.

Technical Description

Available in standard 1U 24 ports or 2U 48 ports, the Universal Panel range offers quality, performance and value.

Tested to exceed all ISO/IEC 11801 and ANSI/TIA/EIA 568-C.2 Category 6 performance standards, the Universal Patch Panel offers backward compatibility with Category 5e, Category 5 and voice products.

The Universal Panel is supplied with a clear plastic channel which protects the PCB and allows easy viewing of wiring label. The Universal Panels are manufactured with 110 punch-down IDC blocks.

Technical Drawings



Front view of Universal 110 Category 6 Panel



Top view of Universal 110 Category 6 Panel

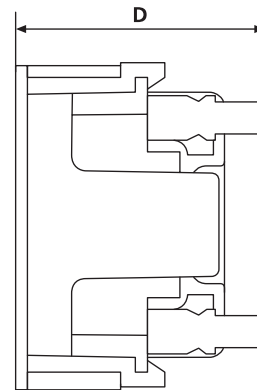

Side view of Universal 110 Category 6 Panel



Universal 110 Category 6 1U 48 Port Panel

Features and Benefits

- Exceeds Category 6 performance standards
- High density panel - 48 ports in 1U
- Vertical 110 IDC punchdown for easy termination
- Supplied with Rack Snap mounting fixings
- Integral rear cable management
- Lower layer numbered 1-24, Top layer numbered 25-48
- Backward compatible to Category 5e and Category 5

6

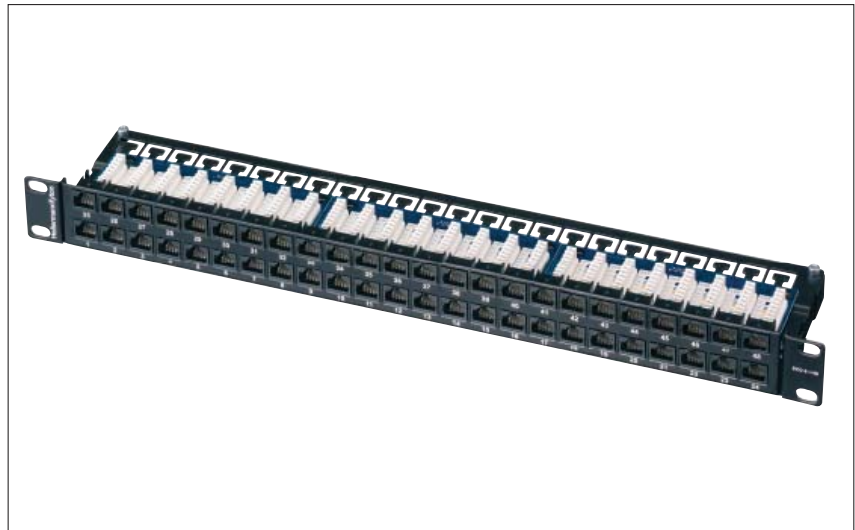

EcoBand Category 6 1U 48 port Panel

Product Description

The Universal 110 Category 6 EcoBand HD Panel enables high density patching presenting 48 ports in 1U and therefore saving rack space. The panels offers exceptional Category 6 performance.

The panel's design allows the upper row of 24 ports to be easily removed allowing access to the lower row of ports. Each row offers rear cable management providing support and protection for the cables. The vertical IDC punchdown ensures ease of installation.

The panel had been designed to support high density installations, where space is limited or is valued at a premium such as data centres and server farms.

Technical Data Table

Article-No.	Type	Performance Category	Height (H)	Width (W)	Depth (D)	Port count
853-50011	PP110C6481U	Category 6 (Class E)	44.0	483.0	91.0	48

All dimensions in mm. Subject to technical changes.

Technical Description

The Universal 110 EcoBand HD Panel presents 48 RJ45 ports in 1U of space. The ports are configured on 2 separate trays, with 24 ports on each tray. Each tray provides cable management using a standard cable tie. Individual ports are screen printed for easy identification.

Tested to exceed all ISO/IEC 11801 and ANSI/TIA/EIA 568-C.2 Category 6 performance standards, the EcoBand Patch Panel offers backward compatibility with Category 5e, Category 5 and voice products. The Universal Panels are manufactured with 110 punch-down IDC blocks.

Technical Drawings



Front view of Category 6 48 port EcoBand Panel

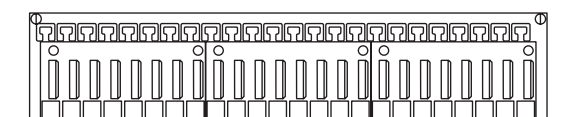

Top view of Category 6 48 port EcoBand Panel

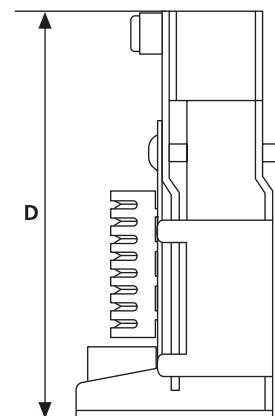

Side view of Category 6 48 port EcoBand Panel



Universal 110 Category 6 Vertical 12 Port Panel

Features and Benefits

- Exceeds Category 6 performance standards
- Stand alone wall mountable panel for quick installation
- 110 IDC punchdown for easy termination
- Configured for T568A and T568B wiring
- Fits into most EIA-310-D standard racks or cabinets with square holes
- Write-on labels provided for easy identification

6



Vertical Universal 110 Category 6 12 port Panel

Product Description

The Vertical Universal 110 Category 6 Patch Panel offers exceptional performance in a 12 port vertical presentation.

Each panel is constructed of 2 modular units, each offering 6 RJ45 ports allowing for any of the 6 port modules to be replaced if damaged at any stage during installation.

The Universal Vertical Panel is wall mountable for quick and easy installation. The Universal Panel offers write-on labelling fields for easy port identification.

Technical Data Table

Article-No.	Type	Performance Category	Height (H)	Width (W)	Depth (D)	Port count
853-50001	PP110C612V	Category 6 (Class E)	85.0	255.0	47.0	12

All dimensions in mm. Subject to technical changes.

Technical Description

With panels also available in standard 1U 24 ports or 2U 48 ports, the Universal Panel range offers quality, performance and value.

Tested to exceed all ISO/IEC 11801 and ANSI/TIA/EIA 568-C.2 Category 6 performance standards, the Universal Patch Panel offers backward compatibility with Category 5e, Category 5 and voice products.

The Universal Panel is supplied with a clear plastic channel which protects the PCB and allows easy viewing of wiring label. The Universal Panels are manufactured with 110 punch-down IDC blocks.

Technical Drawings

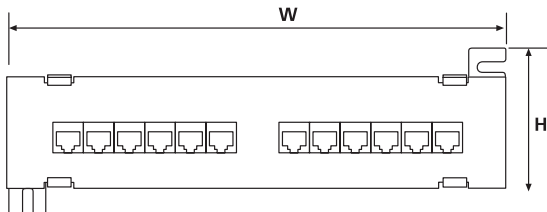

Front view of Vertical Universal 110 Category 6 Panel

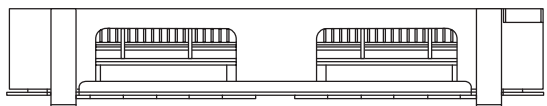

Side view of Vertical Universal 110 Category 6 Panel

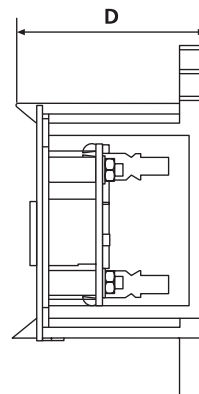

Top view of Vertical Universal 110 Category 6 Panel



Alpha Snap Category 5e 2U 48 Port Panel

Features and Benefits

- Exceeds Category 5e performance standards
- All modules are individually removable and replaceable
- 568A or 568B wiring options
- Supplied with Rack Snap mounting fixings
- Includes aluminium rear cable management as standard
- Patented slide label system and software available
- Backward compatible to Category 5 and voice



Alpha Snap Panel offers 48 Category 5e ports in 2U of space

Product Description

Alpha Snap is the premium Category 5e product range from HellermannTyton. Designed to offer exceptional Category 5e performance and to meet the exacting standards of mission critical installations. The patch panel comprises individual modular PCB's giving ultimate flexibility in the case of port damage or failure.

The Alpha Snap Panel incorporates HellermannTyton's patented sliding label system, enabling clear and effective port identification.

The Alpha Snap Panel is available in 1U 24 port and 2U 48 port versions and is supplied with HellermannTyton's unique aluminium snap-on rear cable manager and Rack Snap mounting fixings as standard.

Technical Data Table

Article-No.	Type	Performance category	Height (H)	Width (W)	Depth (D)	Port count
853-25034	2/48081DCHDC5ECM/BK	Category 5E (Class D)	88.0	483.0	136.0	48

All dimensions in mm. Subject to technical changes.

Technical Description

Alpha Snap Category 5e Patch Panels are available in 1U 24 port and 2U 48 port configurations.

Each of the individual PCB modules are mounted in the unique Alpha Snap plastic moulding which is attached to the front panel.

Each PCB module is equipped with a cable retention bar and the end modules of each horizontal row are colour coded and numbered for error free termination.

The Alpha Label software package, available for download at www.htdata.co.uk enables straightforward port labelling.

Technical Drawings

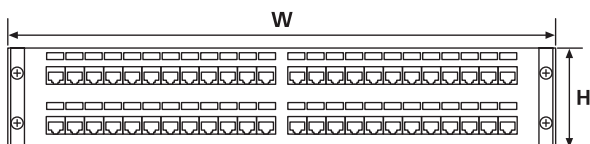

Front View of Alpha Snap Category 5e 48 port Panel

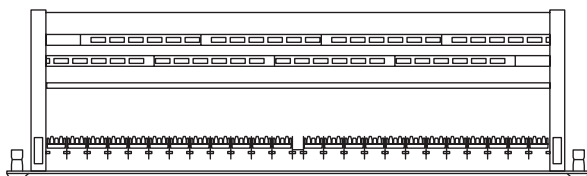

Top View of Alpha Snap Category 5e 48 port Panel

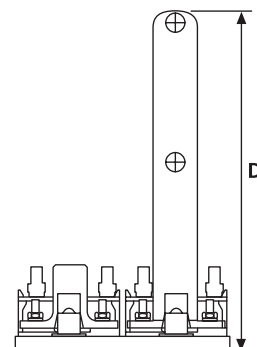

Side View of Alpha Snap Category 5e 48 port Panel



Alpha Snap Category 5e 1U 24 Port Panel

Features and Benefits

- Exceeds Category 5e performance standards
- All modules are individually removable and replaceable
- 568A or 568B wiring options
- Supplied with Rack Snap mounting fixings
- Includes aluminium rear cable management as standard
- Patented slide label system and software available
- Backward compatible to Category 5 and voice



AlphaSnap 1U 24 port Category 5e Panel

Product Description

Alpha Snap is the premium Category 5e product range from HellermannTyton. Designed to offer exceptional Category 5e performance and to meet the exacting standards of mission critical installations. The patch panel comprises individual modular PCB's giving ultimate flexibility in the case of port damage or failure.

The Alpha Snap Panel incorporates HellermannTyton's patented sliding label system, enabling clear and effective port identification.

The Alpha Snap Panel is available in 1U 24 port and 2U 48 port versions and is supplied with HellermannTyton's unique aluminium snap-on rear cable manager and Rack Snap mounting fixings as standard.

Technical Data Table

Article-No.	Type	Performance Category	Height (H)	Width (W)	Depth (D)	Port count
853-30336	1/2408IDCHDC5ECM/BK	Category 5E (Class D)	44.0	483.0	136.0	24

All dimensions in mm. Subject to technical changes.

Technical Description

Alpha Snap Category 5e Patch Panels are available in 1U 24 port and 2U 48 port configurations.

Each of the individual PCB modules are mounted in the unique Alpha Snap plastic moulding which is attached to the front panel.

Each PCB module is equipped with a cable retention bar and the end modules of each horizontal row are colour coded and numbered for error free termination.

The Alpha Label software package, available for download at www.htdata.co.uk enables straightforward port labelling.

Technical Drawings



Front view of Alpha Snap Category 5e Panel

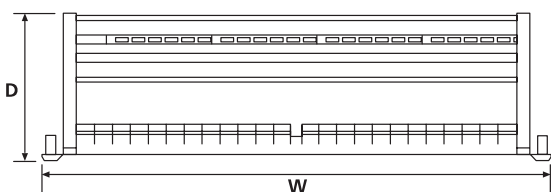

Top view of Alpha Snap Category 5e Panel

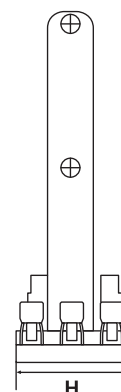

Side view of Alpha Snap Category 5e Panel



Alpha Snap Category 5e 1U 24 Port Jack to Jack Panel

Features and Benefits

- Exceeds Category 5e performance standards
- All modules are individually removable and replaceable
- Supplied with Rack Snap mounting fixings
- Provides front to rear patching
- Patented slide label system and software available
- Backward compatible to Category 5 and voice



Alpha Snap Jack to Jack Category 5e Panel

Product Description

Alpha Snap is the premium Category 5e product range from HellermannTyton. Designed to offer exceptional Category 5e performance and to meet the exacting standards of mission critical installations. The patch panel comprises individual modular PCB's giving ultimate flexibility in the case of port damage or failure.

The Alpha Snap Panel incorporates HellermannTyton's patented sliding label system, enabling clear and effective port identification.

The Alpha Snap Jack to Jack Panel allows front to rear patching using an RJ45 coupler and is supplied with Rack Snap mounting fixings as standard.

Technical Data Table

Article-No.	Type	Performance Category	Height (H)	Width (W)	Depth (D)	Port count
853-30034	1U 24P J/J A/S HD C5E PANEL BK	Category 5E (Class D)	44.0	483.0	35.0	24

All dimensions in mm. Subject to technical changes

Technical Description

Alpha Snap Jack to Jack Category 5e Patch Panels are available in 1U 24 port configurations.

Each of the individual PCB modules are mounted in the unique Alpha Snap plastic moulding which is attached to the front panel.

Each rear RJ45 port is numbered in accordance with the front presentation numbering for easier port identification.

The Alpha Label software package, available for download at www.htdata.co.uk enables straightforward port labelling.

Technical Drawings



Front view of Alpha Snap Category 5e Jack to Jack Panel

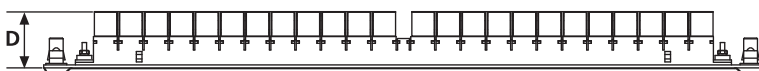

Top view of Alpha Snap Category 5e Jack to Jack Panel

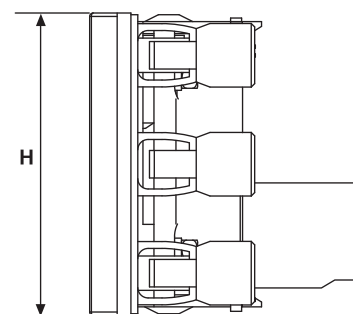

Side view of Alpha Snap Category 5e Jack to Jack Panel



Global Category 5e 2U 48 Port Panel

Features and Benefits

- Exceeds Category 5e performance standards
- Optional rear cable management
- 568A or 568B wiring options
- Double labelling fields and software available
- Magnifying covers over labelling fields
- 4 port RJ45 modules
- Supplied with Rack Snap mounting fixings
- Backward compatible to Category 5 and voice



2U 48 port Category 5e Global Panel is supplied with Rack Snaps as standard

Product Description

The Global Category 5e range of patch panels offer exceptional performance and is available in 1U 24 port and 2U 48 port versions.

Each panel is constructed of 12 modular units, each offering 4 RJ45 ports. The panel can be supplied partially loaded to meet the exact requirements of the application, giving a cost effective solution.

The Global Panel is supplied with Rack Snaps mounting fixings and a rear cable manager is also available. The Global Panel offers 2 labelling fields as standard with a magnifying lens for clear identification.

Technical Data Table

Article-No.	Type	Performance Category	Height (H)	Width (W)	Depth (D)	Port count
853-25031	2/4808IDCG5E/BK	Category 5E (Class D)	88.0	483.0	31.0	48

All dimensions in mm. Subject to technical changes.

Technical Description

Available in standard 1U 24 ports or 2U 48 ports, the Global Panel range offers quality, performance and value.

Tested to exceed all ISO/IEC 11801 and ANSI/TIA/EIA 568-C.2 Category 5e performance standards, the Global Patch Panel offers backward compatibility with Category 5 and voice products.

The jack presentation is a 4 port modular PCB assembly which can be removed and replaced if required.

The Global Panel is supplied with a comprehensive colour and numbering label on the rear modules to ensure error free terminations.

The Alpha Label software package, available for download at www.htdata.co.uk enables straightforward port labelling.

Technical Drawings

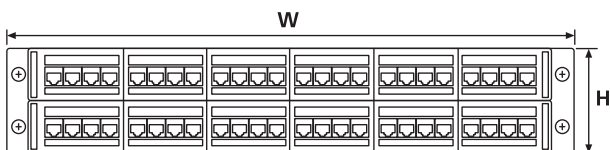

Front view of Category 5e 2U 48 port Global Panel

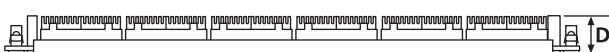

Top view of Category 5e 2U 48 port Global Panel

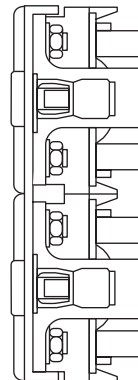

Side view of Category 5e 2U 48 port Global Panel



Global Category 5e 1U 24 Port Panel

Features and Benefits

- Exceeds Category 5e performance standards
- Optional rear cable management
- 568A or 568B wiring options
- Double labelling fields and software available
- Magnifying covers over labelling fields
- 4 port RJ45 modules
- Supplied with Rack Snap mounting fixings
- Backward compatible to Category 5 and voice



1U 24 port Global Panel exceeds Category 5e performance standards

Product Description

The Global Category 5e range of patch panels offer exceptional performance and is available in 1U 24 port and 2U 48 port versions.

Each panel is constructed of 6 modular units, each offering 4 RJ45 ports. The panel can be supplied partially loaded to meet the exact requirements of the application, giving a cost effective solution.

The Global Panel is supplied with Rack Snaps mounting fixings and a rear cable manager is also available. The Global Panel offers 2 labelling fields as standard with a magnifying lens for clear identification.

Article-No.	Type	Performance Category	Height (H)	Width (W)	Depth (D)	Port count
853-25017	1/2408IDCG5E/BK	Category 5E (Class D)	44.0	483.0	31.0	24

All dimensions in mm. Subject to technical changes.

Technical Description

Available in standard 1U 24 ports or 2U 48 ports, the Global Panel range offers quality, performance and value.

Tested to exceed all ISO/IEC 11801 and ANSI/TIA/EIA 568-C.2 Category 5e performance standards, the Global Patch Panel offers backward compatibility with Category 5 and voice products.

The jack presentation is a 4 port modular PCB assembly which can be removed and replaced if required.

The Global Panel is supplied with a comprehensive colour and numbering label on the rear modules to ensure error free terminations.

The Alpha Label software package, available for download at www.htdata.co.uk enables straightforward port labelling.

Technical Drawings

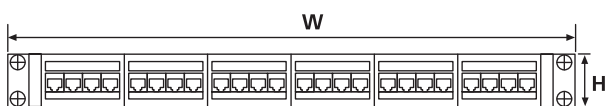

Front view of Category 5e Global Panel

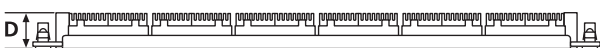

Top view of Category 5e Global Panel

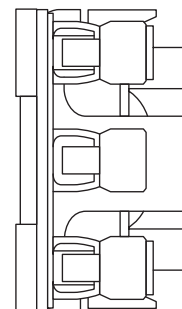

Side view of Category 5e Global Panel



MegaBand Category 5e

2U 48 Port Panel

Features and Benefits

- Exceeds Category 5e performance standards
- Port label numbers printed on panel fascia
- Rack Snap rack mounting fixings included
- Slide in labelling kit included
- Rear cable management available
- Backward compatible with Category 5 and voice applications

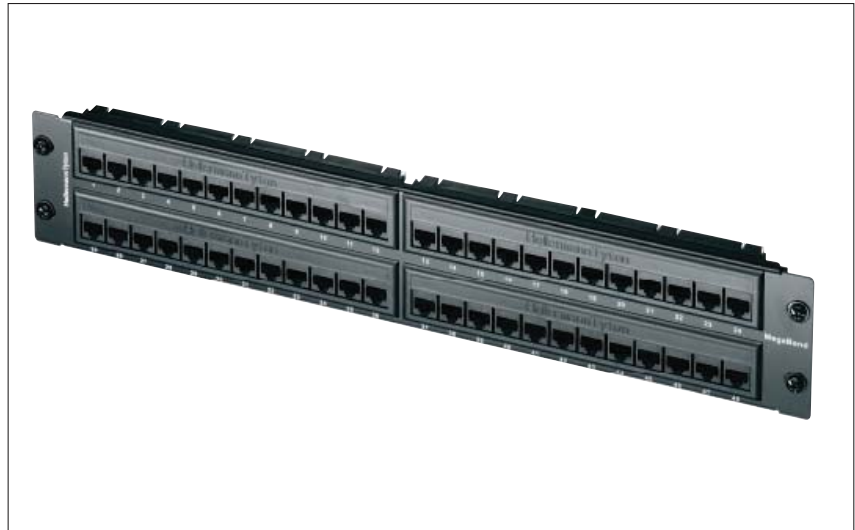

Category 5e MegaBand Panel presenting 48 ports in 2U

Product Description

The MegaBand Panel has been designed to offer exceptional Category 5e performance and value.

Available in 1U 24 port and 2U 48 port versions, the MegaBand Panel is supplied with a sliding label panel and optional rear cable management. The MegaBand Panel is also supplied with Rack Snap mounting fixings as standard.

Technical Data Table

Article-No.	Type	Performance Category	Height (H)	Width (W)	Depth (D)	Port count
853-20111	2/4808-NMB-HD/BK	Category 5E (Class D)	88.0	483.0	30.0	24

All dimensions in mm. Subject to technical changes.

Technical Description

The MegaBand Category 5e Panel is available in 1U 24 port and 2U 48 port versions.

Tested to exceed all ISO/IEC 11801 and ANSI/TIA/EIA 568-C.2 Category 5e performance standards.

The Alpha Label software package, available for download at www.htdata.co.uk enables straightforward port labelling.

Technical Drawings

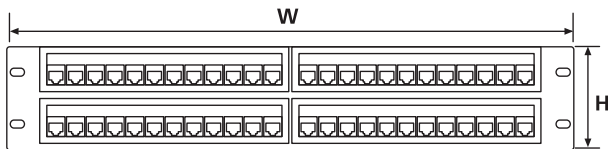

Front view of 2U 48 port MegaBand Panel

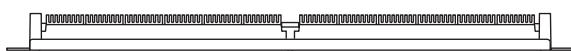

Top view of 2U 48 port MegaBand Panel

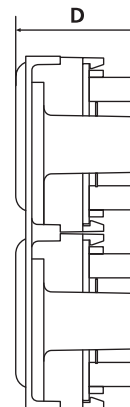

Side view of 2U 48 port MegaBand Panel



**MegaBand Category 5e
1U 24 Port Panel**



Features and Benefits

- Exceeds all Category 5e performance standards
- Port label numbers printed on panel fascia
- Rack Snap rack mounting fixings included
- Slide in labelling kit included
- Rear cable management available
- Backward compatible with Category 5 and voice applications



MegaBand 1U 24 port Category 5e Panel

Product Description

The MegaBand Panel has been designed to offer exceptional Category 5e performance and value.

Available in 1U 24 port and 2U 48 port versions, the MegaBand Panel is supplied with a sliding label panel and optional rear cable management. The MegaBand Panel is also supplied with Rack Snap mounting fixings as standard.

Technical Data Table

Article-No.	Type	Performance Category	Height (H)	Width (W)	Depth (D)	Port count
853-20110	1/2408-NMB-HD/BK	Category 5E (Class D)	44.0	483.0	28.0	24

All dimensions in mm. Subject to technical changes.

Technical Description

The MegaBand Category 5e Panel is available in 1U 24 port and 2U 48 port versions.

Tested to exceeds all ISO/IEC 11801 and ANSI/TIA/EIA 568-C.2 Category 5e performance standards.

The Alpha Label software package, available for download at www.htdata.co.uk enables straightforward port labelling.

Technical Drawings

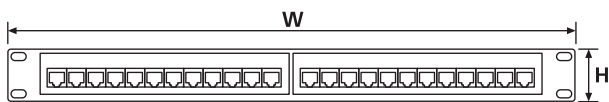

Front view of 1U 24 port Category 5e MegaBand Panel

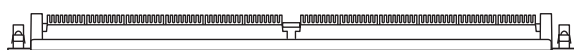

Top view of 1U 24 port Category 5e MegaBand Panel

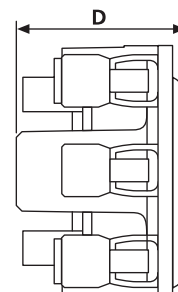

Side view of 1U 24 port Category 5e MegaBand Panel



EcoBand Category 5e

1U 48 Port Panel

Features and Benefits

- Exceeds Category 5e performance standards
- High density panel - 48 ports in 1U
- Vertical IDC punchdown for easy termination
- Supplied with Rack Snap mounting fixings
- Integral rear cable management
- Lower layer numbered 1-24, Top layer numbered 25-48

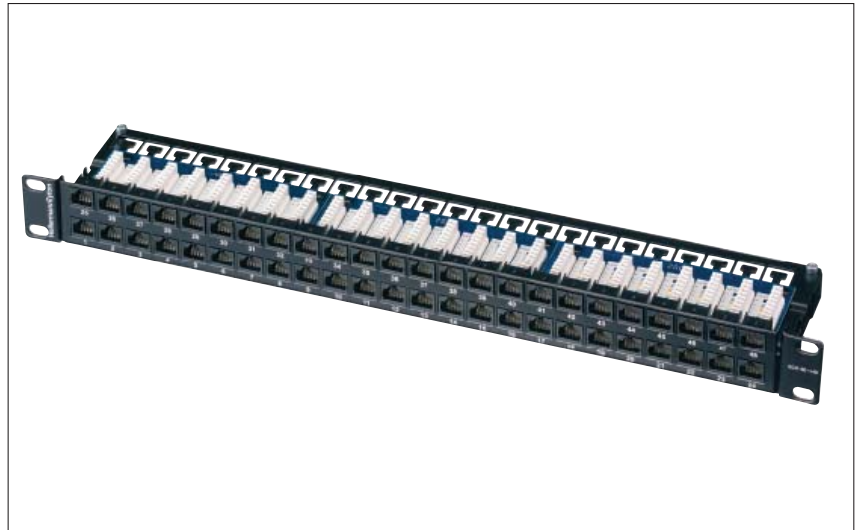

1U 48 port High Density Category 5e EcoBand Panel

Product Description

The Category 5e EcoBand HD Panel enables high density patching presenting 48 ports in 1U and therefore saving rack space. The panel offers exceptional Category 5e performance.

The panel's design allows the upper row of 24 ports to be easily removed allowing access to the lower row of ports. Each row offers rear cable management providing support and protection for the cables. The vertical IDC punchdown ensures ease of installation.

The panel had been designed to support high density installations, where space is limited or is valued at a premium such as data centres and server farms.

Technical Data Table

Article-No.	Type	Performance Category	Height (H)	Width (W)	Depth (D)	Port count
853-30339	1/4808IDC C5E/BK	Category 5E (Class D)	44.0	483.0	131.0	48

All dimensions in mm. Subject to technical changes.

Technical Description

The Category 5e EcoBand HD Panel presents 48 RJ45 ports in 1U of space. The ports are configured on 2 separate trays, with 24 ports on each tray. Each tray provides real cable management using a standard cable tie. Individual ports are screen printed for easy identification.

Tested to exceed all ISO/IEC 11801 and ANSI/TIA/EIA 568-C.2 Category 5e performance standard.

Technical Drawings



Front view of Category 5e 1U 48 port EcoBand Panel

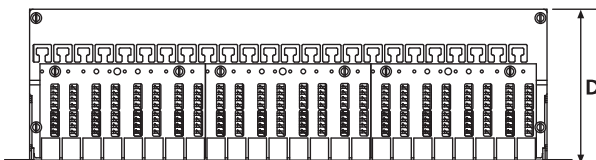

Top view of Category 5e 1U 48 port EcoBand Panel

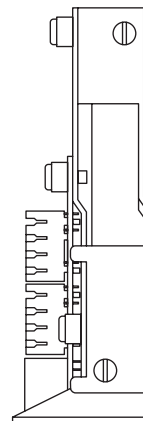

Side view of Category 5e 1U 48 port EcoBand Panel



**EcoBand Category 5e
1U 24 Port Panel**

Features and Benefits

- Exceeds Category 5e performance standards
- Vertical IDC punchdown for easy termination
- Write on label strips
- Screen printed numbering system
- Integral rear cable management
- Includes Rack-Snap mounting fixings

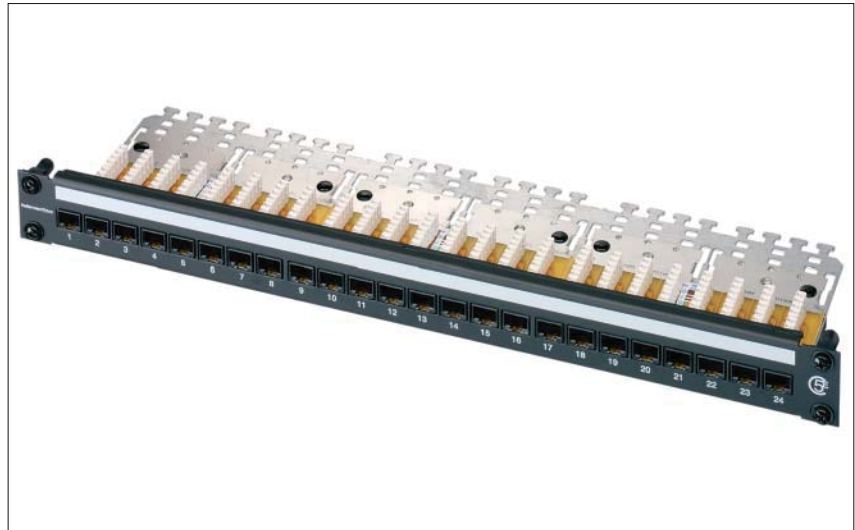

EcoBand Category 5e Right Angled 1U 24 port Panel

Product Description

The Category 5e EcoBand Panel presents 24 Category 5e RJ45 ports in 1U of space with vertical IDC punch down for ease of termination. The robust body of the panel provides integrated rear cable management with a range of cable fixing locations.

Each individual port is screen printed for easy identification with space for end user labelling with the option of a slide label mask.

Each panel comes supplied with Rack Snap mounting fixings as standard.

Technical Data Table

Article-No.	Type	Performance Category	Height (H)	Width (W)	Depth (D)	Port count
853-35056	HT2408PB-U5E-M/BK	Category 5E (Class D)	44.0	483.0	132.0	24

All dimensions in mm. Subject to technical changes.

Technical Description

The Category 5e EcoBand Panel presents 24 Category 5e RJ45 ports in 1U of space with integral rear cable management. Each individual port is screen printed for easy identification.

Tested to exceed all ISO/IEC 11801 and ANSI/TIA/EIA 568-C.2 Category 5e performance standards.

Technical Drawings

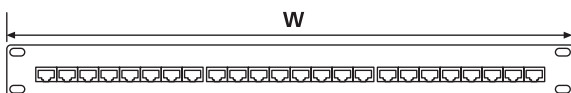

Front view of Category 5e EcoBand Panel

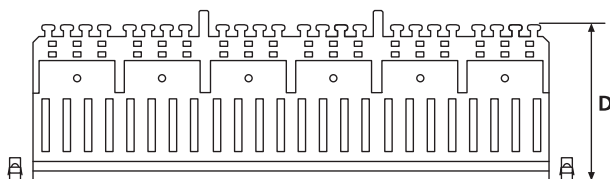

Top view of Category 5e EcoBand Panel

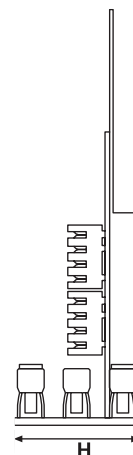

Side view of Category 5e EcoBand Panel



EcoBand Shielded Category 5e 1U 24 Port Panel

Features and Benefits

- Fully shielded for optimum Category 5e performance
- Write on labelling system
- Built in rear management
- Screen printed numbering system
- Pre-assembled with Rack Snaps for easy installation



Shielded Category 5e EcoBand Panel

Product Description

The Shielded Category 5e EcoBand Panel presents 24 Category 5e RJ45 ports in 1U of space with vertical IDC punch down for ease of termination. The robust body of the panel provides integrated rear cable management with a range of cable fixing locations.

Each individual port is screen printed for easy identification with space for end user labelling with the option of a slide label mask.

Each panel comes supplied with Rack Snap mounting fixings as standard.

Technical Data Table

Article-No.	Type	Performance Category	Height (H)	Width (W)	Depth (D)	Port count
853-35090	NGM2408IDC-S5E/BK	Category 5E (Class D)	44.0	483.0	148.0	24

All dimensions in mm. Subject to technical changes.

Technical Description

The Category 5e EcoBand Panel presents 24 Category 5e RJ45 ports in 1U of space with integral rear cable management. Each individual port is screen printed for easy identification.

The Shielded EcoBand Panel is supplied with a metallic lid to maintain the shielding throughout the system.

Tested to exceed all ISO/IEC 11801 and ANSI/TIA/EIA 568-C.2 Category 5e performance standards.

Technical Drawings

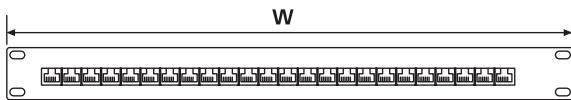

Front view of 24 port Shielded Category 5e EcoBand Panel

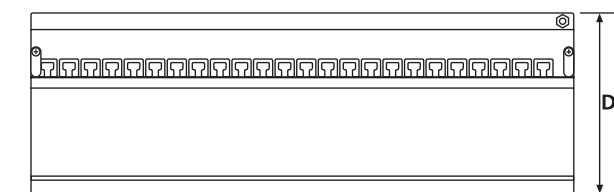

Top view of 24 port Shielded Category 5e EcoBand Panel

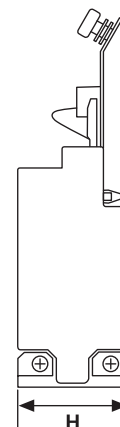

Side view of 24 port Shielded Category 5e EcoBand Panel



Universal 110 Category 5e 2U 48 Port Panel

Features and Benefits

- Exceeds Category 5e performance standards
- Configured for T568A and T568B wiring
- 110 punch-down IDC
- Write-on labels provided for easy identification
- Optional rear cable manager available
- Backward compatible with Category 5 and voice

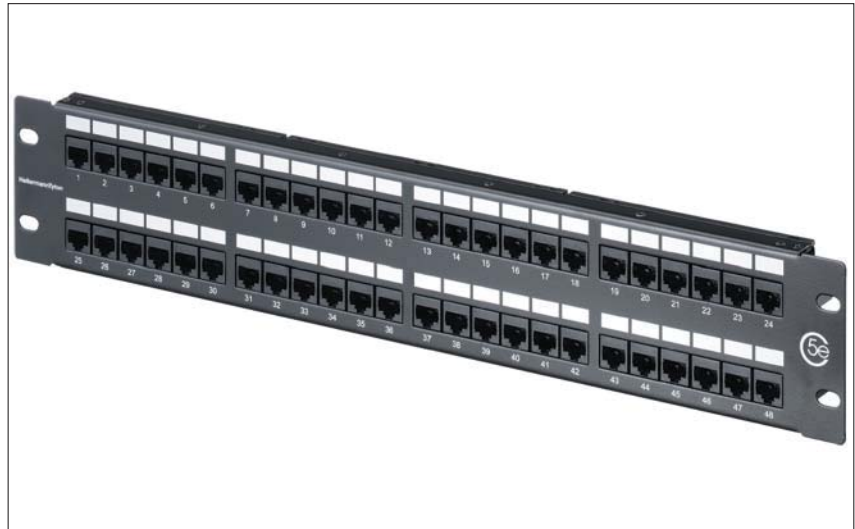

Universal 110 2U 48 port Category 5e Panel

Product Description

The Universal 110 Category 5e range of patch panels offer exceptional performance and is available in 1U 24 port and 2U 48 port versions.

Each panel is constructed of 8 modular units, each offering 6 RJ45 ports allowing for any of the 6 port modules to be replaced if damaged at any stage during installation.

The Universal Panel is supplied with Rack Snaps mounting fixings and a rear cable manager is also available. The Universal Panel offers write-on labelling fields for easy port identification.

Technical Data Table

Article-No.	Type	Performance Category	Height (H)	Width (W)	Depth (D)	Port count
853-20078	PP11 OC5E48	Category 5E (Class D)	88.0	483.0	29.0	48

All dimensions in mm. Subject to technical changes.

Technical Description

Available in standard 1U 24 ports or 2U 48 ports, the Universal Panel range offers quality, performance and value.

Tested to exceed all ISO/IEC 11801 and ANSI/TIA/EIA 568-C.2 Category 5e performance standards, the Universal Patch Panel offers backward compatibility with Category 5 and voice products.

The Universal Panel is supplied with a clear plastic channel which protects the PCB and allows easy viewing of wiring label. The Universal Panels are manufactured with 110 punch-down IDC blocks.

Technical Drawings

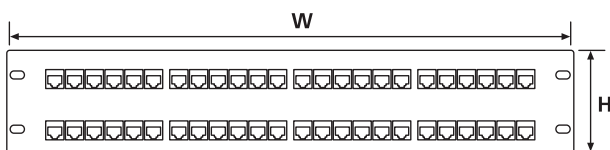

Front view of Universal 110 2U 48 port Category 5e Panel



Top view of Universal 110 2U 48 port Category 5e Panel

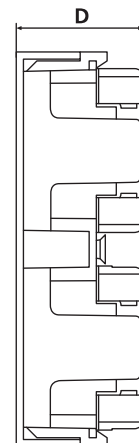

Side view of Universal 110 2U 48 port Category 5e Panel



Universal 110 Category 5e 1U 24 Port Panel

Features and Benefits

- Exceeds Category 5e performance standards
- Configured for T568A and T568B wiring
- 110 punch-down IDC
- Write-on labels provided for easy identification
- Optional rear cable manager available
- Backward compatible with Category 5 and voice



Universal 110 1U 24 port Category 5e Panel

Product Description

The Universal 110 Category 5e range of patch panels offer exceptional performance and is available in 1U 24 port and 2U 48 port versions.

Each panel is constructed of 4 modular units, each offering 6 RJ45 ports allowing for any of the 6 port modules to be replaced if damaged at any stage during installation.

The Universal Panel is supplied with Rack Snaps mounting fixings and a rear cable manager is also available. The Universal Panel offers write-on labelling fields for easy port identification.

Technical Data Table

Article-No.	Type	Performance Category	Height (H)	Width (W)	Depth (D)	Port count
853-20075	PP110C5E24	Category 5E (Class D)	44.0	483.0	34.0	24

All dimensions in mm. Subject to technical changes.

Technical Description

Available in standard 1U 24 ports or 2U 48 ports, the Universal Panel range offers quality, performance and value.

Tested to exceed all ISO/IEC 11801 and ANSI/TIA/EIA 568-C.2 Category 5e performance standards, the Universal Patch Panel offers backward compatibility with Category 5 and voice products.

The Universal Panel is supplied with a clear plastic channel which protects the PCB and allows easy viewing of wiring label. The Universal Panels are manufactured with 110 punch-down IDC blocks.

Technical Drawings

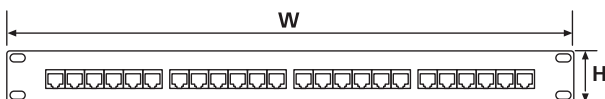

Front view of Universal 110 Category 5e Panel



Top view of Universal 110 Category 5e Panel

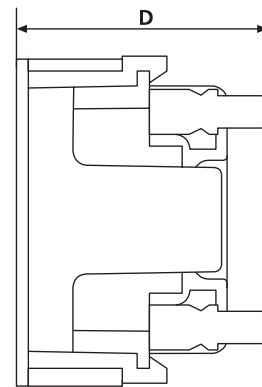

Side view of Universal 110 Category 5e Panel



Universal 110 Category 5e 1U 48 Port Panel

Features and Benefits

- Exceeds Category 5e performance standards
- High density panel - 48 ports in 1U
- Vertical 110 IDC punchdown for easy termination
- Supplied with Rack Snap mounting fixings
- Integral rear cable management
- Lower layer numbered 1-24, Top layer numbered 25-48

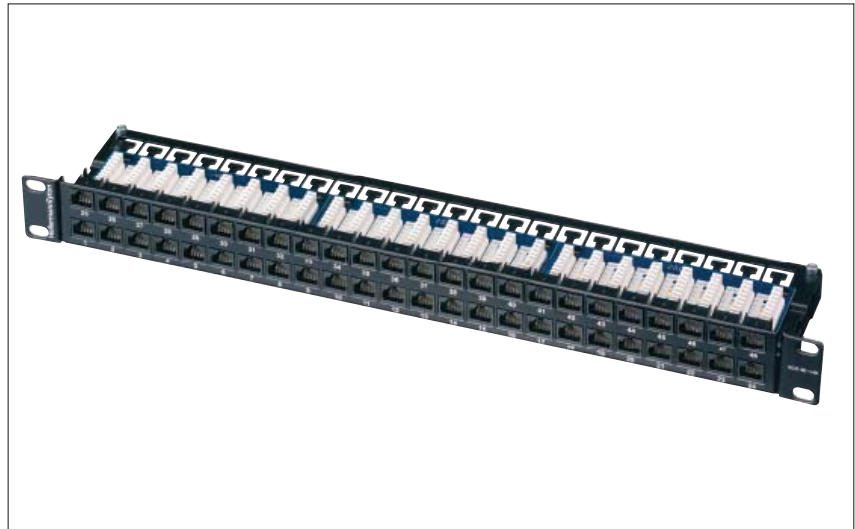

1U 48 port High Density Category 5e EcoBand Panel

Product Description

The Universal 110 Category 5e EcoBand HD Panel enables high density patching presenting 48 ports in 1U and therefore saving rack space. The panels offers exceptional Category 5e performance.

The panel's design allows the upper row of 24 ports to be easily removed allowing access to the lower row of ports. Each row offers rear cable management providing support and protection for the cables. The vertical IDC punchdown ensures ease of installation.

The panel had been designed to support high density installations, where space is limited or is valued at a premium such as data centres and server farms.

Technical Data Table

Article-No.	Type	Performance Category	Height (H)	Width (W)	Depth (D)	Port count
853-15047	PP110C5E481U	Category 5E (Class D)	44.0	483.0	131.0	48

All dimensions in mm. Subject to technical changes.

Technical Description

The Universal 110 EcoBand HD Panel presents 48 RJ45 ports in 1U of space. The ports are configured on 2 separate trays, with 24 ports on each tray. Each tray provides real cable management using a standard cable tie. Individual ports are screen printed for easy identification.

Tested to exceed all ISO/IEC 11801 and ANSI/TIA/EIA 568-C.2 Category 5e performance standard. The Universal Panels are manufactured with 110 punch-down IDC blocks.

Technical Drawings



Front view of Category 5e 48 port EcoBand Panel

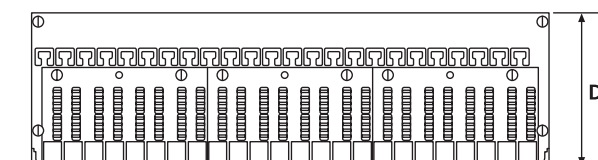

Top view of EcoBand 1U 48 port Category 5e Panel

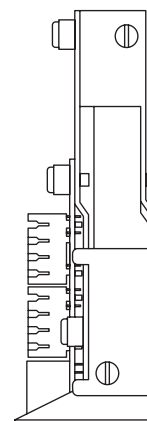

Side view of Category 5e 48 port EcoBand Panel



Universal 110 Category 5e Vertical 12 Port Panel

Features and Benefits

- Exceeds Category 5e performance standards
- Stand alone wall mountable panel for quick installation
- 110 IDC punchdown for easy termination
- Configured for T568A and T568B wiring
- Fits into most EIA-310-D standard racks or cabinets with square holes
- Write-on labels provided for easy identification



Universal 110 12 port Vertical Category 5e Panel

Product Description

The Vertical Universal 110 Category 5e Patch Panel offers exceptional performance in a 12 port vertical presentation.

Each panel is constructed of 2 modular units, each offering 6 RJ45 ports allowing for any of the 6 port modules to be replaced if damaged at any stage during installation.

The Universal Vertical Panel is wall mountable for quick and easy installation. The Universal Panel offers write-on labelling fields for easy port identification.

Technical Data Table

Article-No.	Type	Performance Category	Height (H)	Width (W)	Depth (D)	Port count
853-20074	PP110C5E12V	Category 5E (Class D)	85.0	255.0	47.0	12

All dimensions in mm. Subject to technical changes.

Technical Description

With panels also available in standard 1U 24 ports or 2U 48 ports, the Universal Panel range offers quality, performance and value.

Tested to exceed all ISO/IEC 11801 and ANSI/TIA/EIA 568-C.2 Category 5e performance standards, the Universal patch Panel offers backward compatibility with Category 5 and voice products.

The Universal Panel is supplied with a clear plastic channel which protects the PCB and allows easy viewing of wiring label. The Universal Panels are manufactured with 110 punch-down IDC blocks.

Technical Drawings

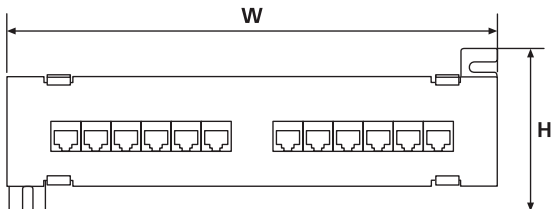

Front view of Universal 110 Vertical Category 5e Panel

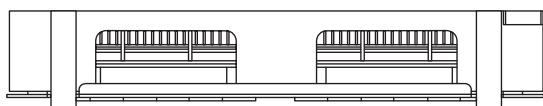

Side view of Universal 110 Vertical Category 5e Panel

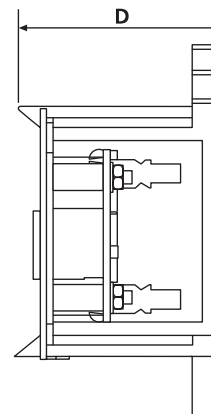

Top view of Universal 110 Vertical Category 5e Panel



Category 3 Voice 50 Port Panel

Features and Benefits

- High Density Voice Panel 50 ports per 1U
- Integral rear cable management
- Screen printed numbered ports
- All 4 pairs presented
- Exceeds all ISO/IEC 11801 and ANSI/TIA/EIA 568-C.2 performance standards
- Rack Snap mounting kit supplied as standard

3



50 port high density Category 3 Voice Panel

Product Description

The High Density Voice Panel offers exceptional Category 3 performance whilst presenting 50 RJ45 voice ports in 1U of space.

The panel enables vertical IDC punch down and has integral rear cable management to provide support and protection for the cables.

Technical Data Table

Article-No.	Type	Performance Category	Height (H)	Width (W)	Depth (D)	Port count
853-00008	1/5008VIDC/BK	Category 3 (Class C)	44.0	483.0	134.0	50

All dimensions in mm. Subject to technical changes.

Technical Description

The High Density Voice Panel presents 50 RJ45 voice ports in 1U of space.

The Voice Panel has been tested to exceed all ISO/IEC 11801 and ANSI/TIA/EIA 568-C.2 Category 3 performance standards.

The High Density Voice Panel is designed to support any existing voice infrastructure running over a Category 3 system.

Technical Drawings

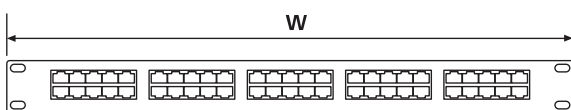

Front View of 50 port Category 3 Voice Panel

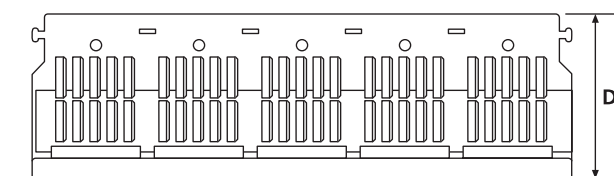

Top View of 50 port Category 3 Voice Panel

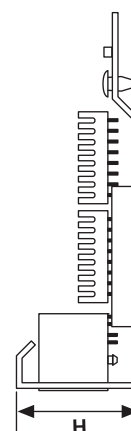

Side View of 50 port Category 3 Voice Panel



Category 3 Voice 25 Port Panel

Features and Benefits

- 1U 25 port Voice Panel
- Integral rear cable management
- Screen printed numbered ports
- All 4 pairs presented
- Exceeds all ISO/IEC 11801 and ANSI/TIA/EIA 568-C.2 performance standards
- Rack Snap mounting kit supplied as standard

3

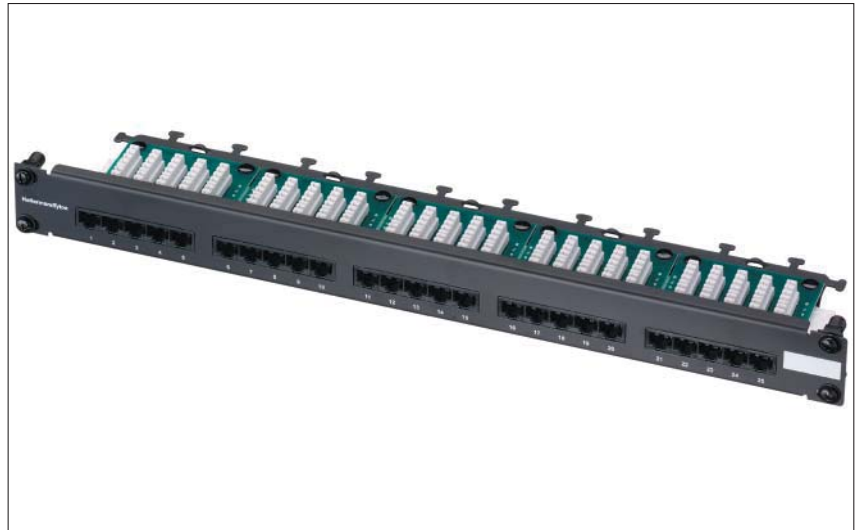

25 port Category 3 Voice Panel

Product Description

The standard Voice Panel offers exceptional Category 3 performance whilst presenting 25 RJ45 voice ports in 1U of space.

The panel enables vertical IDC punch down and has integral rear cable management to provide support and protection for the cables.

Technical Data Table

Article-No.	Type	Performance Category	Height (H)	Width (W)	Depth (D)	Port count
853-00004	1/2508VIDC4PR/BK	Category 3 (Class C)	44.0	483.0	102.0	25

All dimensions in mm. Subject to technical changes.

Technical Description

The standard panel presents 25 RJ45 voice ports in 1U of space.

The Voice Panel has been tested to exceed all ISO/IEC 11801 and ANSI/TIA/EIA 568-C.2 Category 3 performance standards.

The panel is designed to support any existing voice infrastructure running over a Category 3 system.

Technical Drawings

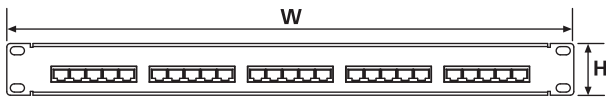

Front view of 25 port Category 3 Voice Panel

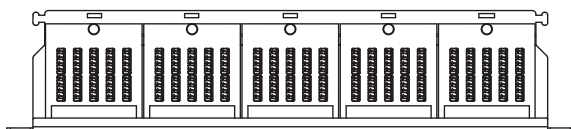

Top view of 25 port Category 3 Voice Panel

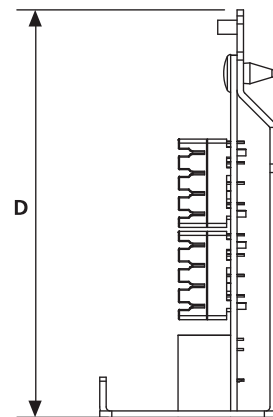

Side view of 25 port Category 3 Voice Panel



3 Data Outlets

	Page
3.1 Category 6A Outlets	
Deca ¹⁰ Keystone Jack	100
3.2 Category 6 Outlets	
GigaBand Category 6	
Single Outlet	101
Coloured Single Outlets	102
Triple Outlet	105
Easy Clip Category 6	
Single Outlet	103
6C Category 6	
Single Outlet	104
Angled Outlet	107
Global Category 6	
4 Port Outlet	106
Keystone Jacks Category 6	
Category 6 Jack	108
GigaBand Shielded Category 6	
Single Outlet	109
Coloured Single Outlets	110
Easy Clip Shielded Category 6	
Single Outlet	111
3.3 Category 5e Outlets	
Alpha Snap Category 5e	
Single Outlet	112

	Page
Coloured Single Outlets	113
Jack to Jack Single Outlet	116
Low Profile Single Outlet	117
Triple Outlet	118
Easy Clip Category 5e	
Single Outlet	114
6C Category 5e	
Single Outlet	115
Angled Outlet	120
Global Category 5e	
4 Port Outlet	119
MegaBand Category 5e	
Single Outlet	121
Keystone Jacks Category 5e	
Category 5e Jack	122
Alpha Snap Shielded Category 5e	
Single Outlet	123
Coloured Single Outlets	124
Easy Clip Shielded Category 5e	
Single Outlet	125
3.4 Keystone Jacks Category 3	
Category 3 Jack	126



Deca¹⁰ Category 6A

Keystone Jack

Features and Benefits

- Exceeds ISO/EIA 11801:2002 and ANSI/TIA/EIA 568 - C.2 Category 6A/Class EA standards
- Quality die cast body
- 360° shielding ensures all round protection from alien crosstalk
- Single action hand tool termination
- No punchdown tool required
- Backward compatible with Category 6, Category 5e, Category 5 and voice

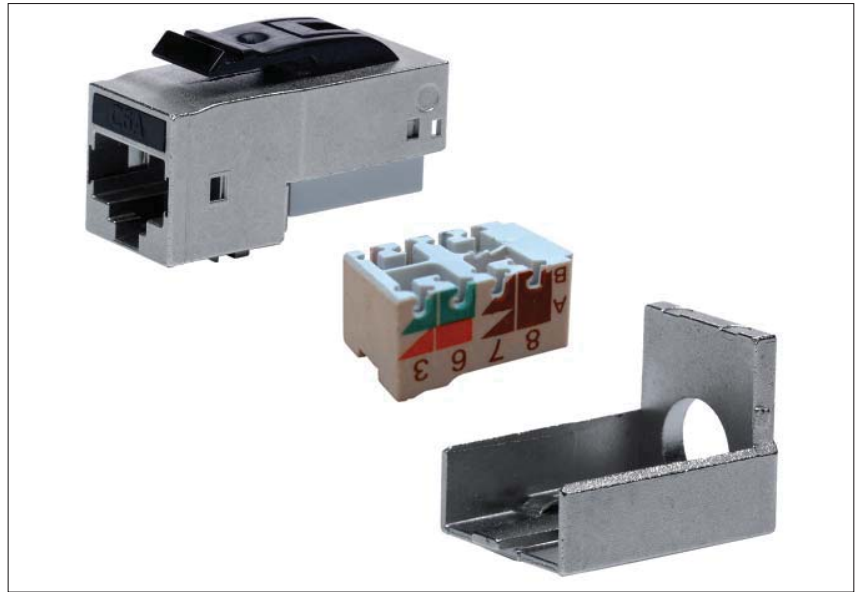

The Deca¹⁰ solution provides 360° shielding and eliminates alien crosstalk

Product Description

The Deca¹⁰ Keystone Jack utilises HellermannTyton's patented 10-pin technology to deliver superior Category 6A performance. The die cast shielded body enables exceptional alien crosstalk results whilst ensuring that the product is robust and has a high quality finish.

The Deca¹⁰ Keystone has been designed to be 'non-punchdown'. All 8 terminations are made at once using our special high speed termination tool (see accessories), helping to ensure quality and consistency of the connections and speeding up the termination process.

Technical Data Table

Article-No.	Type	Performance Category	Height (H)	Width (W)	Depth (D)	Port count	Quantity	Colour
852-40000	KSJ08SC6A	Category 6A (Class EA)	23.0	16.0	36.0	1	1	Mill Finish (MLFS)
852-40002	KSJ08SC6A-12	Category 6A (Class EA)	23.0	16.0	36.0	1	12	Mill Finish (MLFS)

All dimensions in mm. Subject to technical changes.

Technical Description

The Deca¹⁰ Keystone Jack has been uniquely designed adopting HellermannTyton's globally tried and tested 10-Pin technology which guarantees superior performance and connectivity.

Tested to exceed ISO/EIA 11801:2002 and ANSI/TIA/EIA 568 - C.2 standards, the Deca¹⁰ Category 6A system offers backward compatibility with Category 6, Category 5e, Category 5 and voice products.

Technical Drawings

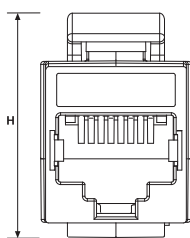

Front view of Category 6A shielded Keystone Jack

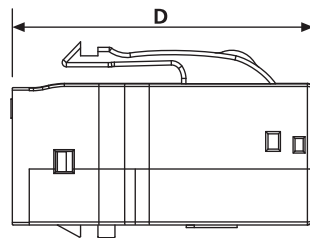

Side view of Category 6A shielded Keystone Jack

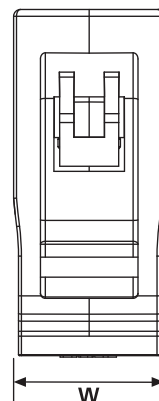

Top view of Category 6A shielded Keystone Jack



GigaBand Category 6 Single Outlet

Features and Benefits

- Fully modular - individual PCB's
- Exceeds Category 6 performance standards
- Rear cable tie point
- Patented slide label system
- 568A or 568B wiring options
- Colour options available
- Labelling software available

6



GigaBand Category 6 Outlet from HellermannTyton

Product Description

The GigaBand Outlet forms part of the leading Category 6 GigaBand product range from HellermannTyton. The individual modular design of the GigaBand system allows for uncompromised performance and quality.

GigaBand Outlets offer exceptional Category 6 performance and are available in either standard (25mm x 50mm) or high density (50mm x 50mm) triple format.

Technical Data Table

Article-No.	Type	Performance Category	Height (H)	Width (W)	Depth (D)	Colour
852-05185	AS08IDCNGB/WH	Category 6 (Class E)	50.0	25.0	34.0	White (WH)

All dimensions in mm. Subject to technical changes.

Technical Description

GigaBand Outlets are available in both proprietary HellermannTyton (Alpha Snap) and industry standard (Easy Clip) mounting sizes.

The GigaBand Outlets are tested to exceed all ISO/IEC 11801 and ANSI/TIA/EIA 568-C.2 Category 6 performance standards and are backward compatible with Category 5e, Category 5 and voice products.

The Alpha Label software package, available for download at www.htdata.co.uk enables straightforward port labelling.

Technical Drawings

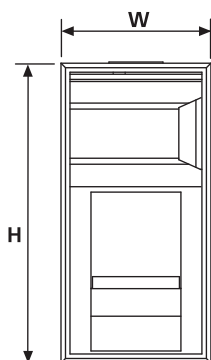

Front View of Category 6 GigaBand module

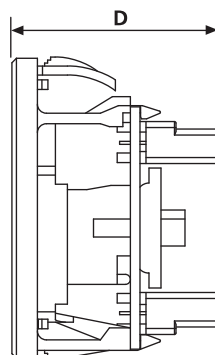

Side View of Category 6 GigaBand module

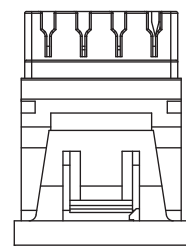

Top View of Category 6 GigaBand module



GigaBand Category 6 Coloured Single Outlets

Features and Benefits

- Fully modular - individual PCB's
- Exceeds Category 6 performance standards
- Rear cable tie point
- Patented slide label system
- 568A or 568B wiring options
- Colour options available
- Labelling software available

6



Coloured GigaBand Category 6 Outlets

Product Description

The GigaBand Coloured Outlet forms part of the leading Category 6 GigaBand product range from HellermannTyton and is available in Black (BK), Blue (BL), Green (GN) and Red (RD). The individual modular design of the GigaBand system allows for uncompromised performance and quality.

GigaBand Outlets offer exceptional Category 6 performance and are available in standard (25mm x 50mm) size.

Technical Data Table

Article-No.	Type	Performance Category	Height (H)	Width (W)	Depth (D)	Port count	Colour
852-05184	AS08IDCNGB/BK	Category 6 (Class E)	50.0	25.0	35.0	1	Black (BK)
852-05506	AS08IDCNGB/BL	Category 6 (Class E)	50.0	25.0	35.0	1	Blue (BU)
852-05587	AS08IDCNGB/GN	Category 6 (Class E)	50.0	25.0	34.0	1	Green (GN)
852-05577	AS08IDCNGB/RD	Category 6 (Class E)	50.0	25.0	35.0	1	Red (RD)

†† dimensions in mm. Subject to technical changes

Technical Description

GigaBand Coloured Outlets are only available in proprietary HellermannTyton (Alpha Snap) mounting size.

The GigaBand Outlets are tested to exceed all ISO/IEC 11801 and ANSI/TIA/EIA 568-C.2 Category 6 performance standards and are backward compatible with Category 5e, Category 5 and voice products.

The Alpha Label software package, available for download at www.htdata.co.uk enables straightforward port labelling.

Technical Drawings

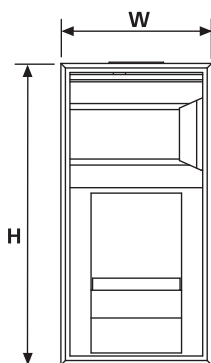

Front View of Category 6 GigaBand module

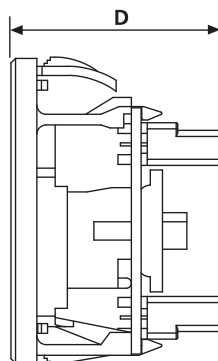

Side View of Category 6 GigaBand module

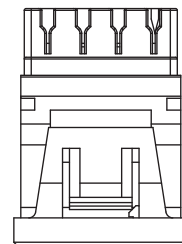

Top View of Category 6 GigaBand module



Easy Clip Category 6 Single Outlet

Features and Benefits

- Fully modular - individual PCB's
- Exceeds Category 6 performance standards
- Rear cable tie point
- Patented slide label system
- 568A or 568B wiring options
- Black and white options available
- Labelling software available

6



Easy Clip GigaBand Category 6 Outlets available in Black and White

Product Description

The GigaBand Easy Clip Outlet forms part of the leading Category 6 GigaBand product range from HellermannTyton. The individual modular design of the GigaBand system allows for uncompromised performance and quality.

GigaBand Outlets offer exceptional Category 6 performance and are available in a standard 25mm x 50mm single format.

Technical Data Table

Article-No.	Type	Performance Category	Height (H)	Width (W)	Depth (D)	Port count	Quantity	Colour
852-05380	EC08IDCNGB/BK	Category 6 (Class E)	50.0	25.0	34.0	1	1	Black (BK)
852-05381	EC08IDCNGB/WH	Category 6 (Class E)	50.0	25.0	34.0	1	1	White (WH)

All dimensions in mm. Subject to technical changes.

Technical Description

GigaBand Outlets are available in both proprietary HellermannTyton (Alpha Snap) and industry standard (Easy Clip) mounting sizes.

The GigaBand Outlets are tested to exceed all ISO/IEC 11801 and ANSI/TIA/EIA 568-C.2 Category 6 performance standards and are backwards compatible with Category 5e, Category 5 and voice products.

The Alpha Label software package, available for download at www.htdata.co.uk, enables straightforward port labelling.

Technical Drawings

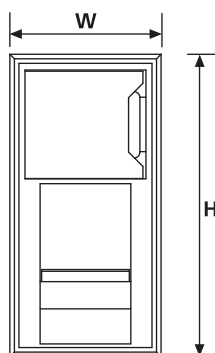

Front view of Category 6 Easy Clip single module

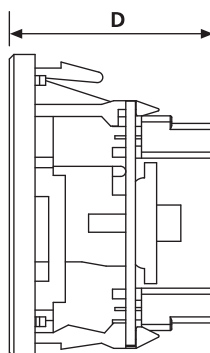

Side view of Category 6 Easy Clip single module

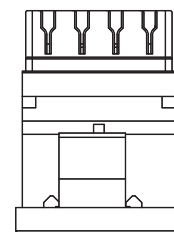

Top view of Category 6 Easy Clip single module



6C Category 6 Single Outlet

Features and Benefits

- Industry standard 6C dimensions
- Suitable for floor box applications
- Exceeds Category 6 performance standards
- Shuttered to ensure dust free operation
- Available with slide in labels
- Black and white options available

6



6C Category 6 Outlets available in Black and White

Product Description

The Category 6 6C Outlet conforms to the industry standard 6C fixing dimensions and is compatible with the numerous floor boxes, face plates and trunking accessories available for 6C connectors.

Technical Data Table

Article-No.	Type	Performance Category	Height (H)	Width (W)	Depth (D)	Port count	Quantity	Colour
852-30053	6C08IDCNGB-MSK/BK	Category 6 (Class E)	39.0	25.0	34.0	1	1	Black (BK)
852-30019	6C08IDCNGB-MSK/WH	Category 6 (Class E)	39.0	25.0	34.0	1	1	White (WH)

All dimensions in mm. Subject to technical changes.

Technical Description

The HellermannTyton 6C module is an industry standard sized connector widely used in floor box applications.

The individual PCB modules are mounted in the unique Alpha Snap plastic moulding which ensures that the PCB cannot be removed by accident. A plastic cable management loop, with a wire colouring and numbering label is secured to the rear of the PCB, ensuring error free termination.

Tested to exceed all ISO/IEC 11801 and ANSI/TIA/EIA 568-C.2 Category 6 performance standards.

The Alpha Label software package, available for download at www.htdata.co.uk enables straightforward port labelling.

Technical Drawings

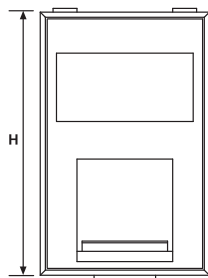

Front view of Category 6 6C module

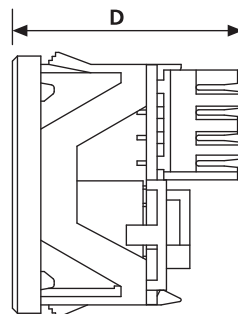

Side view of Category 6 6C module

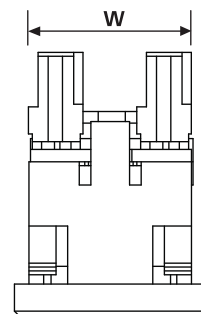

Top view of Category 6 6C module



GigaBand Category 6 Triple Outlet

Features and Benefits

- Triple Outlet features 3 shuttered modular RJ45 outlets
- Fully modular - individual PCB's
- Exceeds Category 6 performance standards
- Rear cable tie point
- Patented slide label system
- 568A or 568B wiring options

6



The Triple Outlet offers high density Category 6 performance

Product Description

The GigaBand Outlet forms part of the leading Category 6 GigaBand product range from HellermannTyton. The individual modular design of the GigaBand system allows for uncompromised performance and quality.

GigaBand Outlets offer exceptional Category 6 performance and are available in either standard (25mm x 50mm) or high density (50mm x 50mm) triple format.

Technical Data Table

Article-No.	Type	Performance Category	Height (H)	Width (W)	Depth (D)	Port count	Colour
852-05305	ASFP03-3L-NGB/WH	Category 6 (Class E)	50.0	50.0	38.0	3	White (WH)

All dimensions in mm. Subject to technical changes.

Technical Description

GigaBand Triple Outlets are only available in proprietary HellermannTyton (Alpha Snap) mounting size.

The GigaBand Outlets are tested to exceed all ISO/IEC 11801 and ANSI/TIA/EIA 568-C.2 Category 6 performance standards and are backwards compatible with Category 5E, Category 5 and voice products.

The Alpha Label software package, available for download at www.htdata.co.uk enables straightforward port labelling.

Technical Drawings

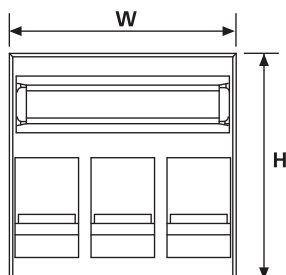

Front view of Category 6 GigaBand Triple module

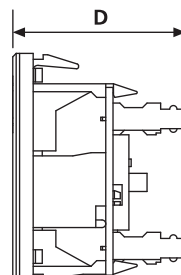

Side view of Category 6 GigaBand Triple module

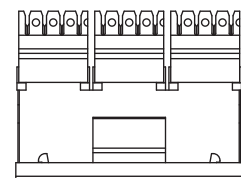

Top view of Category 6 GigaBand Triple module



Global Category 6

4 Port Outlet

Features and Benefits

- Compact 4 port outlet (single gang faceplate)
- Dual label fields with magnifying lens
- High Port Density
- Labelling software available
- Comes with rear cable management clip
- 568A or 568B wiring options
- Incorporates a 4 port snap-in PCB assembly mounted within a standard faceplate

6



Global Outlets offer 4 ports in a single gang space

Product Description

The Global Category 6 Outlet has been designed to accommodate the same 4 port module used in the Global Panels and provides a high port density for data and voice services within a single gang space.

Designed specifically for office environments, the Global Category 6 Outlet offers multiple services to one location.

This product is commonly used on service poles where power is supplied on one side and data/voice on the other, networking multiple desks.

Technical Data Table

Article-No.	Type	Performance Category	Height (H)	Width (W)	Depth (D)	Port count	Colour
852-35130	0408IDCG6/WH	Category 6 (Class E)	86.0	86.0	30.0	4	White (WH)

All dimensions in mm. Subject to technical changes.

Technical Description

The Global Category 6 Outlets incorporate a 4 port snap-in PCB assembly mounted within a standard single gang UK face plate.

The Global Category 6 Outlets are tested to exceed all ISO/IEC 11801 and ANSI/TIA/EIA 568-C.2 Category 6 performance standards and are backwards compatible with Category 5e, Category 5 and voice products.

The four way PCB module is mounted in a plastic carrier with a rear clip. A label showing the colour code is mounted on the rear cable management clip. Each port presented at the front can be identified using the unique labelling system with magnifying label.

The Alpha Label software package, available for download at www.htdata.co.uk enables straightforward port labelling.

Technical Drawings

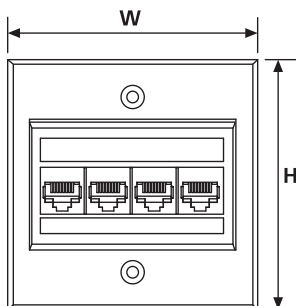

Front view of Category 6 Global 4 Port module

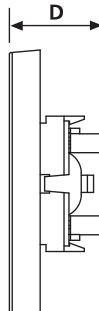

Side view of Category 6 Global 4 Port module

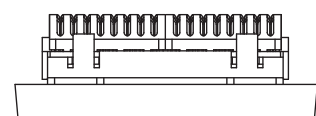

Top view of Category 6 Global 4 Port module



6C Category 6 Angled Outlet

Features and Benefits

- Angled design allows for patch lead bend management in floor box applications
- Minimal depth in front of module
- Industry standard 6C dimensions
- Suitable for floor box applications
- Exceeds Category 6 performance standards
- Shuttered to ensure dust free operation
- Magnified window protects label

6



Angled design allows for bend management in floor box applications

Product Description

The 6C 45 degree outlet is a low profile module that has been developed to give the user a reliable cabling outlet that reduces the space required both in front and behind the outlet. Designed for use in the floor box to prevent crushing of the patch lead as it exits the outlet, it is equally at home in a wall or desk outlet.

This 6C Angled Outlet has been designed to survive the dusty environment of a floor box, the integral shutter ensures that foreign bodies can not damage the pins within the jack.

The integral labelling window offers the customer an ideal method of identifying each outlet. The clear window is designed to magnify the ports identity and protect the label from dust.

Technical Data Table

Article-No.	Type	Performance Category	Height (H)	Width (W)	Depth (D)	Port count	Quantity	Colour
852-30037	6C-ANG-C6/WH	Category 6 (Class E)	39.0	25.0	44.0	1	10	White (WH)

All dimensions in mm. Subject to technical changes.

Technical Description

The HellermannTyton 6C 45 degree module is an industry standard 6C sized connector, enabling 2 modules to be fitted in a single gang face plate or four modules into a double gang face plate.

The connector uses the HellermannTyton Keystone RJ45 Modular Jack which incorporates a cable management clip for rear strain relief and a clear wire colouring and numbering label to ensure error free termination.

Tested to exceed all ISO/IEC 11801 and ANSI/TIA/EIA 568-C.2 Category 6 performance standards.

The Alpha Label software package, available for download at www.htdata.co.uk enables straightforward port labelling.

Technical Drawings

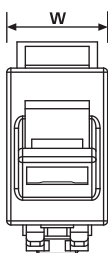

Front view of Category 6 Angled 6C module

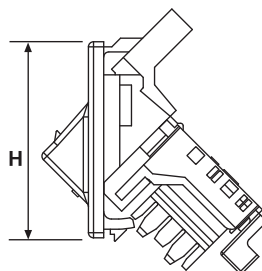

Side view of Category 6 Angled 6C module

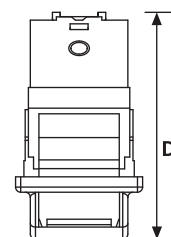

Top view of Category 6 Angled 6C module



Keystone Jacks

Category 6 Jacks

Features and Benefits

- Industry standard modular 'Keystone' dimensions
- Exceeds Category 6 performance standards
- Rear cable tie point
- 110 IDC termination
- 12 coloured jack options
- Palm tool for easy on site installation
- 568A and 568B wiring options



Category 6 Keystone Jacks - 12 different colours available

6

Product Description

HellermannTyton's Category 6 modular Keystone Jack is designed to future proof installations. Its patented contact design uses innovative alien crosstalk cancellation technology, ensuring industry leading performance.

Available in the following colours: W (White), FW (Office White), I (Ivory), GRN (Green), RED (Red), BLU (Blue), BRN (Brown), YEL (Yellow), ORN (Orange), GRY (Grey) and BLK (Black). Bulk packs of 50 Keystone Jacks available on request.

Technical Data Table

Article-No.	Type	Performance Category	Height (H)	Width (W)	Depth (D)	Port count	Quantity	Colour
852-25064	RJ45FC6-BLK	Category 6 (Class E)	23.0	19.0	42.0	1	1	Black (BK)
852-25065	RJ45FC6-BLU	Category 6 (Class E)	23.0	19.0	42.0	1	1	Blue (BU)
852-25067	RJ45FC6-BRN	Category 6 (Class E)	23.0	19.0	42.0	1	1	Brown (BN)
852-25069	RJ45FC6-FW	Category 6 (Class E)	23.0	19.0	42.0	1	1	Office White (OEWH)
852-25070	RJ45FC6-GRN	Category 6 (Class E)	23.0	19.0	42.0	1	1	Green (GN)
852-25071	RJ45FC6-GRY	Category 6 (Class E)	23.0	19.0	42.0	1	1	Grey (GY)
852-25072	RJ45FC6-I	Category 6 (Class E)	23.0	19.0	42.0	1	1	Ivory (IV)
852-25073	RJ45FC6-ORN	Category 6 (Class E)	23.0	19.0	42.0	1	1	Orange (OG)
852-25074	RJ45FC6-RED	Category 6 (Class E)	23.0	19.0	42.0	1	1	Red (RD)
852-25080	RJ45FC6-VIO	Category 6 (Class E)	23.0	19.0	42.0	1	1	Violet (VT)
852-25081	RJ45FC6-W	Category 6 (Class E)	23.0	19.0	42.0	1	1	White (WH)
852-25082	RJ45FC6-YEL	Category 6 (Class E)	23.0	19.0	42.0	1	1	Yellow (YE)

All dimensions in mm. Subject to technical changes.

Technical Description

The performance of the Category 6 system provides significant margin over TIA Category 6 and ISO/IEC 11801 Class D requirements.

Adapters are available to enable the Keystone Jack to be assembled with the GigaBand/Alpha Snap Shuttered Outlet and 6C Angled module.

Technical Drawings

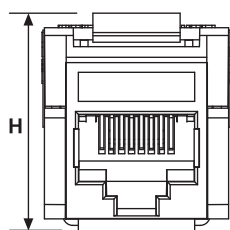

Front view of Category 6 Keystone Jack

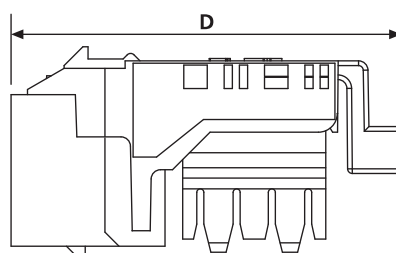

Side view of Category 6 Keystone Jack

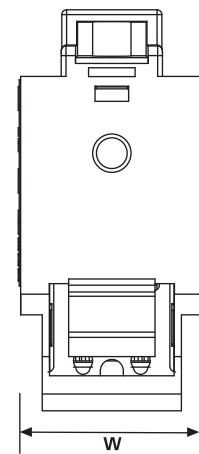

Top view of Category 6 Keystone Jack



GigaBand Shielded Category 6 Single Outlet

Features and Benefits

- Shielded Jack
- Fully modular PCB
- Exceeds Category 6 performance standards
- Patented slide label system and software
- 568A or 568B wiring options
- Module colour options available
- Rear cable tie point

6



The GigaBand Shielded Outlet exceeds Category 6 performance standards

Product Description

GigaBand is the leading Category 6 product group within the HellermannTyton cabling system product range. Designed to offer exceptional Category 6 performance and to meet the exacting standards of mission critical installations.

The GigaBand Shielded Outlet is available in standard single (25mm x 50mm) format.

Technical Data Table

Article-No.	Type	Performance Category	Height (H)	Width (W)	Depth (D)	Colour
852-05187	AS08IDCNGBSLD/WH	Category 6 (Class E)	50.0	25.0	34.0	White (WH)

All dimensions in mm. Subject to technical changes.

Technical Description

GigaBand Outlets are available in both proprietary HellermannTyton (Alpha Snap) and industry standard (Easy Clip) mounting sizes.

The GigaBand Outlets are tested to exceed all ISO/IEC 11801 and ANSI/TIA/EIA 568-C.2 Category 6 performance standards. The GigaBand Outlet offers backward compatibility with Category 5e, Category 5 and voice products.

The Alpha Label software package, available for download at www.htdata.co.uk enables straightforward port labelling.

Technical Drawings

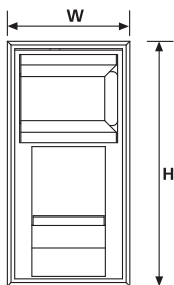

Front view of Category 6 GigaBand shielded module

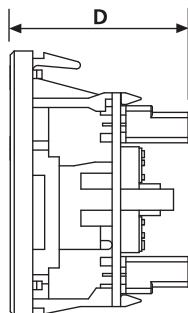

Side view of Category 6 GigaBand shielded module

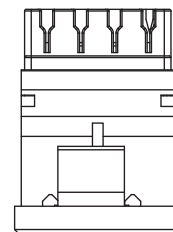

Top view of Category 6 GigaBand shielded module



GigaBand Shielded Category 6 Coloured Outlets

Features and Benefits

- Shielded Jack
- Fully modular PCB
- Exceeds Category 6 performance standards
- Patented slide label system and software
- 568A or 568B wiring options
- Module colour options available
- Rear cable tie point

6



Coloured GigaBand Category 6 Outlets

Product Description

GigaBand is the leading Category 6 product group within the HellermannTyton cabling system product range. Designed to offer exceptional Category 6 performance and to meet the exacting standards of mission critical installations.

The GigaBand Coloured Outlet is available in Black (BK), Blue (BL), Green (GN) and Red (RD).

The GigaBand Shielded Outlet is available in standard single (25mm x 50mm) format.

Technical Data Table

Article-No.	Type	Performance Category	Height (H)	Width (W)	Depth (D)	Port count	Colour
852-05186	AS08IDCNGBSLD/BK	Category 6 (Class E)	50.0	25.0	34.0	1	Black (BK)
852-05594	AS08IDCNGBSLD/BL	Category 6 (Class E)	50.0	25.0	34.0	1	Blue (BU)
852-05595	AS08IDCNGBSLD/GN	Category 6 (Class E)	50.0	25.0	34.0	1	Green (GN)
852-05596	AS08IDCNGBSLD/RD	Category 6 (Class E)	50.0	25.0	34.0	1	Red (RD)

All dimensions in mm. Subject to technical changes.

Technical Description

GigaBand Coloured Outlets are only available in proprietary HellermannTyton (Alpha Snap) mounting size.

The GigaBand Outlets are tested to exceed all ISO/IEC 11801 and ANSI/TIA/EIA 568-C.2 Category 6 performance standards. The GigaBand Outlet offers backward compatibility with Category 5e, Category 5 and voice products.

The Alpha Label software package, available for download at www.htdata.co.uk enables straightforward port labelling.

Technical Drawings

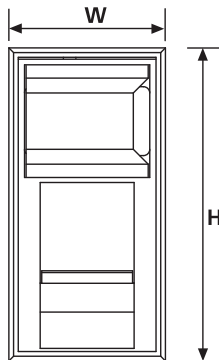

Front view of Category 6 GigaBand shielded module

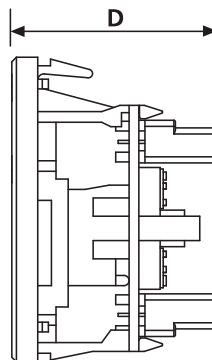

Side view of Category 6 GigaBand shielded module

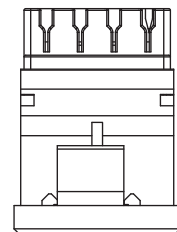

Top view of Category 6 GigaBand shielded module



Easy Clip Shielded Category 6 Single Outlet

Features and Benefits

- Shielded Jack
- Fully modular PCB
- Exceeds Category 6 performance standards
- Patented slide label system and software
- 568A or 568B wiring options
- Module colour options available
- Rear cable tie point

6



Easy Clip GigaBand Category 6 Outlets available in Black and White

Product Description

The GigaBand Outlet forms part of the premium Category 6 GigaBand product range from HellermannTyton. The individual modular design of the GigaBand system allows for uncompromised performance and quality.

GigaBand shielded Outlets offer exceptional Category 6 performance and are available in standard single (25mm x 50mm) format.

Technical Data Table

Article-No.	Type	Performance Category	Height (H)	Width (W)	Depth (D)	Port count	Quantity	Colour
852-05582	EC08IDCNGBSLD/BK	Category 6 (Class E)	50.0	25.0	34.0	1	1	Black (BK)
852-05382	EC08IDCNGBSLD/WH	Category 6 (Class E)	50.0	25.0	34.0	1	1	White (WH)

All dimensions in mm. Subject to technical changes.

Technical Description

GigaBand Outlets are available in both proprietary HellermannTyton (Alpha Snap) and industry standard (Easy Clip) mounting sizes.

The GigaBand Outlets are tested to exceed all ISO/IEC 11801 and ANSI/TIA/EIA 568-C.2 Category 6 performance standards. The GigaBand outlet offers backward compatibility with Category 5e, Category 5 and voice products.

The Alpha Label software package, available for download at www.htdata.co.uk enables straightforward port labelling.

Technical Drawings

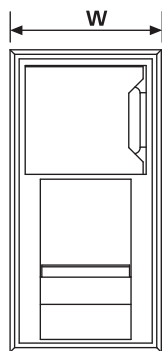

Front view of Category 6 Easy Clip single shielded module

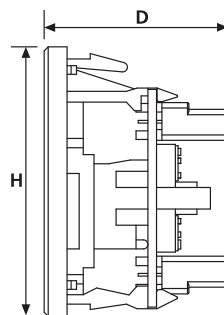

Side view of Category 6 Easy Clip single shielded module

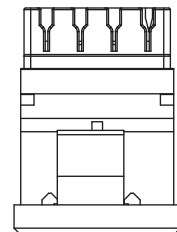

Top view of Category 6 Easy Clip single shielded module



Alpha Snap Category 5e Single Outlet

Features and Benefits

- Fully modular PCB's
- Exceeds Category 5e performance standard
- Patented slide label system and software available
- 568A or 568B wiring options
- Module colour options available
- Rear cable tie point

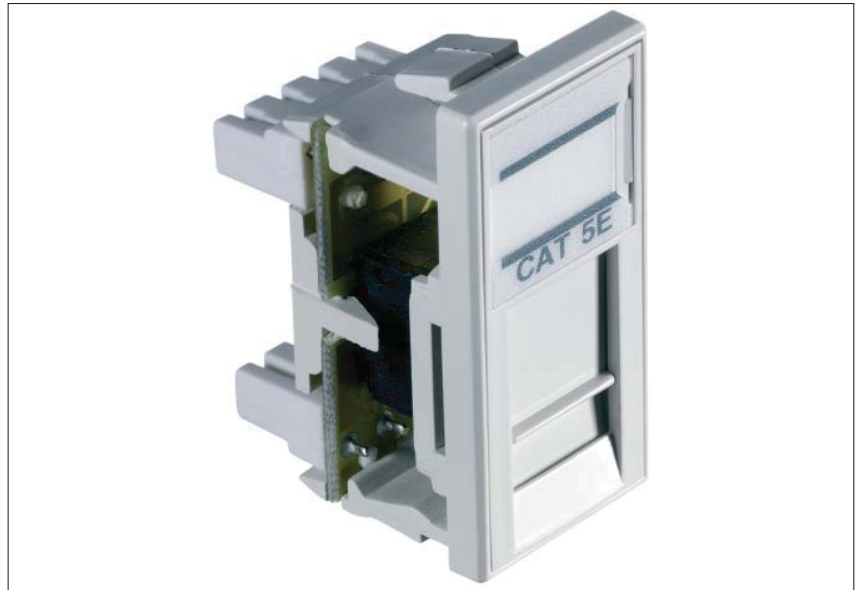

Alpha Snap Outlets exceed the Category 5e performance standards

Product Description

Alpha Snap is the leading Category 5e product group within the HellermannTyton cabling system product range. Designed to offer exceptional Category 5e performance and to meet the exacting standards of mission critical installations.

The Alpha Snap Outlet is available in either standard single (25mm x 50mm) or high density triple (50mm x 50mm) format.

Technical Data Table

Article-No.	Type	Performance Category	Height (H)	Width (W)	Depth (D)	Colour
852-05237	AS08KBC5E/WH	Category 5E (Class D)	50.0	25.0	34.0	White (WH)

All dimensions in mm. Subject to technical changes.

Technical Description

The Alpha Snap Outlet is available in both proprietary HellermannTyton (Alpha Snap) and industry standard (Easy Clip) mounting sizes.

Tested to exceed all ISO/IEC 11801 and ANSI/TIA/EIA 568-C.2 Category 5e performance standards the Alpha Snap Outlet offers backward compatibility with Category 5 and voice products.

The Alpha Label software package, available for download at www.htdata.co.uk enables straightforward port labelling.

Technical Drawings

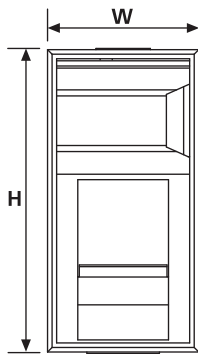

Front view of Category 5e Alpha Snap single module

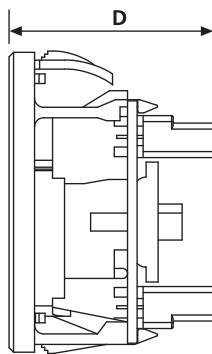

Side view of Category 5e Alpha Snap single module

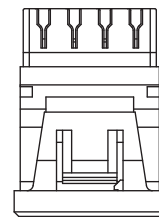

Top view of Category 5e Alpha Snap single module



Alpha Snap Category 5e Coloured Single Outlets

Features and Benefits

- Fully modular PCB's
- Exceeds Category 5e performance standards
- Patented slide label system and software available
- 568A or 568B wiring options
- Module colour options available
- Rear cable tie point



Coloured Alpha Snap Category 5e Outlets

Product Description

Alpha Snap is the leading Category 5e product group within the HellermannTyton cabling system product range. Designed to offer exceptional Category 5e performance and to meet the exacting standards of mission critical installations.

The Alpha Snap Coloured Outlet is available in Black (BK), Blue (BL), Green (GN) and Red (RD).

The Alpha Snap Outlet is available in standard single (25mm x 50mm) size.

Technical Data Table

Article-No.	Type	Performance Category	Height (H)	Width (W)	Depth (D)	Port count	Colour
852-05603	AS08KBC5E/BK	Category 5E (Class D)	50.0	25.0	34.0	1	Black (BK)
852-05604	AS08KBC5E/BL	Category 5E (Class D)	50.0	25.0	34.0	1	Blue (BU)
852-05605	AS08KBC5E/GN	Category 5E (Class D)	50.0	25.0	34.0	1	Green (GN)
852-05606	AS08KBC5E/RD	Category 5E (Class D)	50.0	25.0	34.0	1	Red (RD)

All dimensions in mm. Subject to technical changes

Technical Description

Alpha Snap Coloured Outlets are only available in proprietary HellermannTyton (Alpha Snap) mounting size.

Tested to exceed all ISO/IEC 11801 and ANSI/TIA/EIA 568-C.2 Category 5e performance standards the Alpha Snap Outlet offers backward compatibility with Category 5 and voice products.

The Alpha Label software package, available for download at www.htdata.co.uk enables straightforward port labelling.

Technical Drawings

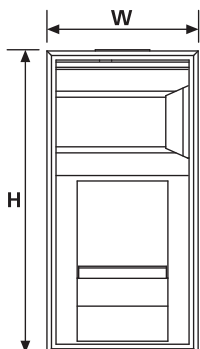

Front view of Category 5e Alpha Snap single module

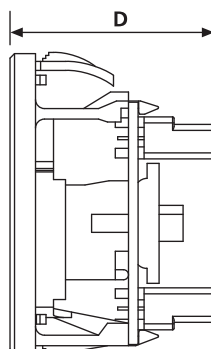

Side view of Category 5e Alpha Snap single module

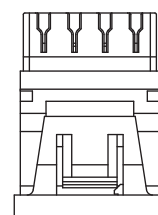

Top view of Category 5e Alpha Snap single module



Easy Clip Category 5e Single Outlet

Features and Benefits

- Fully modular - individual PCB's
- Exceeds Category 5e performance standards
- Rear cable tie point
- Patented slide label system
- 568A or 568B wiring options
- Black and white options available
- Labelling software available



Easy Clip Category 5e Outlets available in black and white

Product Description

Alpha Snap is the leading Category 5e product group within the HellermannTyton cabling system product range. Designed to offer exceptional Category 5e performance and to meet the exacting standards of mission critical installations.

The Alpha Snap Easy Clip Outlet is available in a standard single 25mm x 50mm format.

Technical Data Table

Article-No.	Type	Performance Category	Height (H)	Width (W)	Depth (D)	Port count	Quantity	Colour
852-05611	EC08KBC5E/BK	Category 5E (Class D)	50.0	25.0	34.0	1	1	Black (BK)
852-05386	EC08KBC5E/WH	Category 5E (Class D)	50.0	25.0	34.0	1	1	White (WH)

All dimensions in mm. Subject to technical changes.

Technical Description

The Alpha Snap Outlet is available in both proprietary HellermannTyton (Alpha Snap) and industry standard (Easy Clip) mounting sizes.

Tested to exceed all ISO/IEC 11801 and ANSI/TIA/EIA 568-C.2 Category 5e performance standards the Alpha Snap Outlet offers backward compatibility with Category 5 and voice products.

The Alpha Label software package, available for download at www.htdata.co.uk enables straightforward port labelling.

Technical Drawings

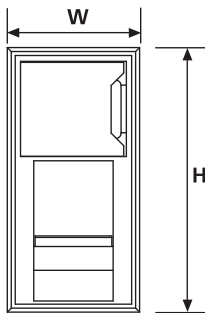

Front view of Category 5e Easy Clip single module

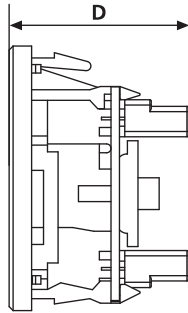

Side view of Category 5e Easy Clip single module

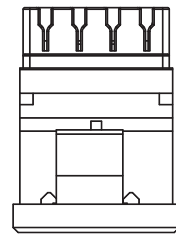

Top view of Category 5e Easy Clip single module



6C Category 5e Single Outlet

Features and Benefits

- Exceeds Category 5e performance standards
- Industry standard 6C dimensions
- Suitable for floor box applications
- Shuttered to ensure dust free operation
- Available with slide in labels



Category 5e 6C Outlets available in black and white options

Product Description

The Category 5e 6C Outlet conforms to the industry standard 6C fixing dimensions and is compatible with the numerous floor boxes, face plates and trunking accessories available for 6C connectors.

Technical Data Table

Article-No.	Type	Performance Category	Height (H)	Width (W)	Depth (D)	Port count	Quantity	Colour
852-30055	6C08IDCC5E-MSK/BK	Category 5E (Class D)	39.0	25.0	34.0	1	1	Black (BK)
852-30054	6C08IDCC5E-MSK/WH	Category 5E (Class D)	39.0	25.0	34.0	1	1	White (WH)

All dimensions in mm. Subject to technical changes.

Technical Description

The HellermannTyton 6C module is an industry standard sized connector widely used in floor box applications.

The individual PCB modules are mounted in the unique Alpha Snap plastic moulding which ensures that the PCB cannot be removed by accident. A plastic cable management loop, with a wire colouring and numbering label is secured to the rear of the PCB, ensuring error free termination.

Tested to exceed all ISO/IEC 11801 and ANSI/TIA/EIA 568-C.2 Category 5e performance standards.

The Alpha Label software package, available for download at www.htdata.co.uk enables straightforward port labelling.

Technical Drawings

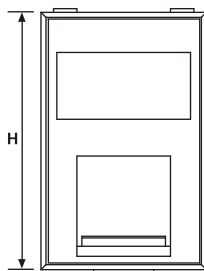

Front view of Category 5e 6C module

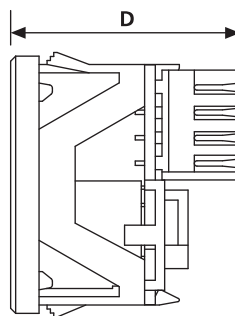

Side view of Category 5e 6C module

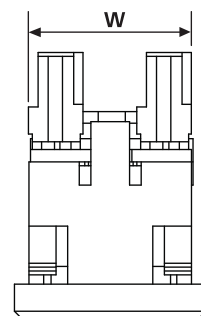

Top view of Category 5e 6C module



Alpha Snap Category 5e Jack to Jack Single Outlet

Features and Benefits

- Fully modular PCB's
- Exceeds Category 5e performance standards
- Through coupler module



Alpha Snap Category 5e Jack to Jack Outlet

Product Description

Alpha Snap is the leading Category 5e product group within the HellermannTyton cabling system product range. Designed to offer exceptional Category 5e performance and to meet the exacting standards of mission critical installations.

The Jack to Jack module acts as a through coupler for two RJ45 patch cords allowing continuous Category 5e connectivity.

The Alpha Snap Jack to Jack Outlet is available in standard 25mm x 50mm

Technical Data Table

Article-No.	Type	Performance Category	Height (H)	Width (W)	Depth (D)	Colour
852-05197	AS08J-J-C5E/WH	Category 5E (Class D)	50.0	25.0	38.0	White (WH)

All dimensions in mm. Subject to technical changes.

Technical Description

The Alpha Snap Jack to Jack Outlet is only available in proprietary HellermannTyton (Alpha Snap) mounting sizes.

Tested to exceed all ISO/IEC 11801 and ANSI/TIA/EIA 568-C.2 Category 5e performance standards the Alpha Snap Outlet offers backward compatibility with Category 5 and voice products.

The Alpha Label software package, available for download at www.htdata.co.uk enables straightforward port labelling.

Technical Drawings

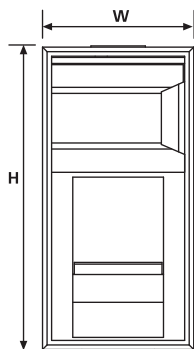

Front view of Category 5e
Alpha Snap Jack to Jack module

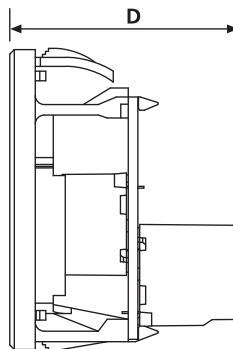

Side view of Category 5e
Alpha Snap Jack to Jack module

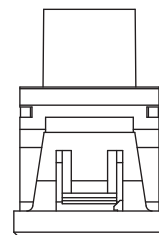

Top view of Category 5e
Alpha Snap Jack to Jack module



Alpha Snap Category 5e Low Profile Single Outlet

Features and Benefits

- Low profile depth of 25mm
- Exceeds Category 5e performance standards
- Patented slide label system and software available
- Rear cable tie point

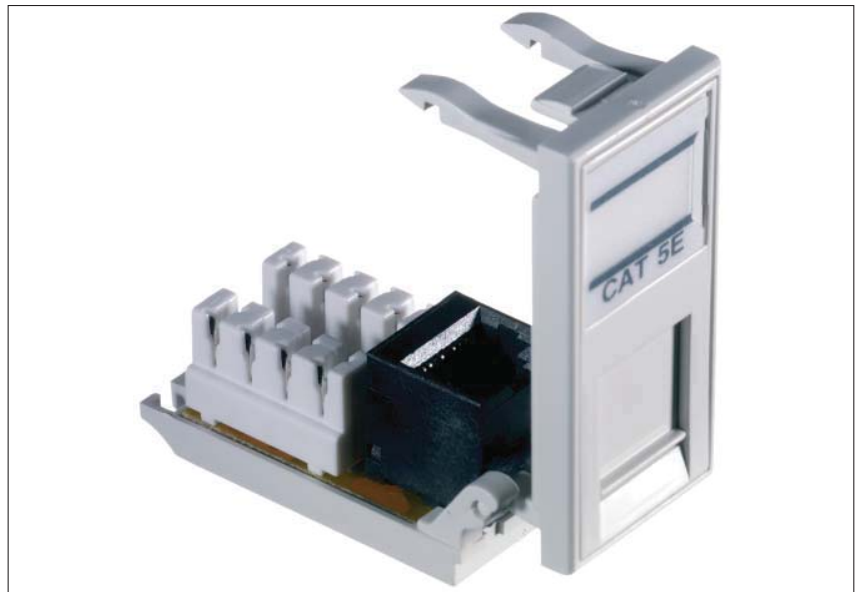

Low Profile outlets are designed for where internal back box space is limited or for shallow trunking

Product Description

The Alpha Snap Low Profile Outlet is available in the standard 25mm x 50mm Alpha Snap format and is designed for applications where internal back box space is limited or where shallow trunking systems or raceways are used and maintains the same design and appearance as other outlets in the Alpha Snap range.

The Alpha Snap Low Profile Outlet fits HellermannTyton bevelled and flat faceplates available in single and double gang formats.

Technical Data Table

Article-No.	Type	Performance Category	Height (H)	Width (W)	Depth (D)	Colour
852-05267	AS08KBLPC5E/WH	Category 5E (Class D)	50.0	35.0	24.0	White (WH)

All dimensions in mm. Subject to technical changes.

Technical Description

The Alpha Snap Low Profile Outlet is only available in proprietary HellermannTyton (Alpha Snap) mounting size.

Tested to exceed all ISO/IEC 11801 and ANSI/TIA/EIA 568-C.2 Category 5e performance standards the Alpha Snap Outlet offers backward compatibility with Category 5 and voice products.

The Low Profile Outlet is supplied with a copper core colouring and numbering label to ensure error free terminations.

The Alpha Label software package available online to download at www.htdata.co.uk enables straightforward port labelling.

Technical Drawings

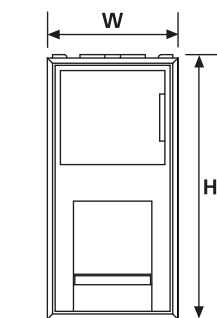

Front view of Category 5e
Alpha Snap low profile module

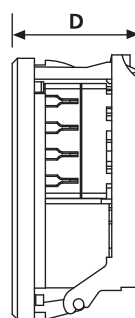

Side view of Category 5e
Alpha Snap low profile module

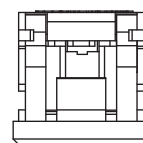

Top view of Category 5e
Alpha Snap low profile module



Alpha Snap Category 5e Triple Outlet

Features and Benefits

- Triple Outlet features 3 shuttered modular RJ45 outlets
- Fully modular PCB's
- Exceeds Category 5e performance standards
- Patented slide label system and software available
- 568A or 568B wiring options
- Rear cable tie point



The triple Alpha Snap module offers 3 ports in a single gang space

Product Description

Alpha Snap is the leading Category 5e product group within the HellermannTyton cabling system product range. Designed to offer exceptional Category 5e performance and to meet the exacting standards of mission critical installations.

The Alpha Snap Outlet is available in either standard single (25mm x 50mm) or high density triple (50mm x 50mm) format.

The high density Alpha Snap Triple Outlet provides 3 ports that fit a single gang faceplate or 6 ports when using a double gang faceplate and a second triple. The high density outlet offers the same high quality Category 5e performance as the single Alpha Snap Outlet.

Technical Data Table

Article-No.	Type	Performance Category	Height (H)	Width (W)	Depth (D)	Port count	Colour
852-05303	ASFP03-3LC5E/WH	Category 5E (Class D)	50.0	50.0	38.0	3	White (WH)

All dimensions in mm. Subject to technical changes.

Technical Description

The Alpha Snap Triple Outlet is only available in proprietary HellermannTyton (Alpha Snap) mounting size.

Tested to exceed all ISO/IEC 11801 and ANSI/TIA/EIA 568-C.2 Category 5e performance standards the Alpha Snap Outlet offers backward compatibility with Category 5 and voice products.

The Alpha Label software package, available for download at www.htdata.co.uk enables straightforward port labelling.

Technical Drawings

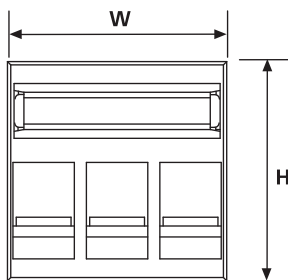

Front view of Category 5e Alpha Snap Triple module

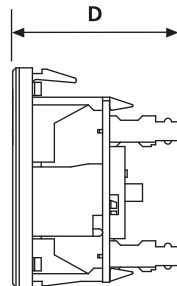

Side view of Category 5e Alpha Snap Triple module

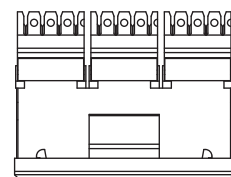

Top view of Category 5e Alpha Snap Triple module



Global Category 5e 4 Port Outlet

Features and Benefits

- Compact 4 port outlet (single gang faceplate)
- Dual label fields with magnifying lens
- High port density
- Labelling software available
- Comes with rear cable management clip
- 568A or 568B wiring options
- Incorporates a 4 port snap-in PCB assembly mounted within a standard faceplate



The 4 port Global module incorporates the single gang face plate

Product Description

The Global Category 5e Outlet has been designed to accommodate the same 4 port module used in the Global Panels and provides a high port density for data and voice services within a single gang space.

Designed specifically for office environments. The Global Category 5e Outlet offers multiple services to one location.

This product is commonly used on service poles where power is supplied on one side and data/voice on the other, networking multiple desks.

Technical Data Table

Article-No.	Type	Performance Category	Height (H)	Width (W)	Depth (D)	Port count	Colour
853-25000	0408IDCG5E/WH	Category 5E (Class D)	86.0	86.0	30.0	4	White (WH)

All dimensions in mm. Subject to technical changes.

Technical Description

The Global Category 5e Outlets incorporate a 4 port snap-in PCB assembly mounted within a standard single gang UK face plate.

The Global Category 5e Outlets are tested to exceed all ISO/IEC 11801 and ANSI/TIA/EIA 568-C.2 Category 5e performance standards and are backwards compatible with Category 5 and voice products.

The four way PCB module is mounted in a plastic carrier with a rear clip. A label showing the colour code is mounted on the rear cable management clip. Each port presented at the front can be identified using the unique labelling system with magnifying label.

The Alpha Label software package, available for download at www.htdata.co.uk enables straightforward port labelling.

Technical Drawings

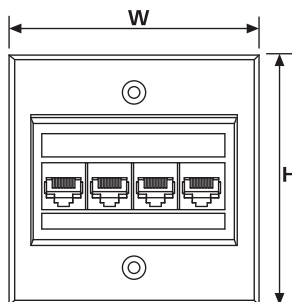

Front view of Category 5e Global 4 Port module

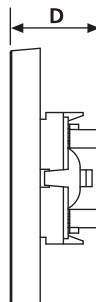

Side view of Category 5e Global 4 Port module

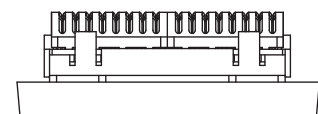

Top view of Category 5e Global 4 Port module



6C Category 5e Angled Outlet

Features and Benefits

- Angled design allows for patch lead bend management in floor box applications
- Minimal depth in front of module
- Industry standard 6C dimensions
- Suitable for floor box applications
- Exceeds Category 5e performance standards
- Shuttered to ensure dust free operation
- Magnified window protects label



Angled design allows for bend management in floor box applications

Product Description

The 6C 45 degree outlet is a low profile module that has been developed to give the user a reliable cabling outlet that reduces the space required both in front and behind the outlet. Designed for use in the floor box to prevent crushing of the patch lead as it exits the outlet, it is equally at home in a wall or desk outlet.

This 6C Angled Outlet has been designed to survive the dusty environment of a floor box, the integral shutter ensures that foreign bodies can not damage the pins within the jack.

The integral labelling window offers the customer an ideal method of identifying each outlet. The clear window is designed to magnify the ports identity and protect the label from dust.

Technical Data Table

Article-No.	Type	Performance Category	Height (H)	Width (W)	Depth (D)	Port count	Quantity	Colour
852-30039	6C-ANG-C5E/WH	Category 5E (Class D)	39.0	25.0	44.0	1	10	White (WH)

All dimensions in mm. Subject to technical changes.

Technical Description

The HellermannTyton 6C 45 degree module is an industry standard 6C sized connector, enabling 2 modules to be fitted in a single gang face plate or four modules into a double gang face plate.

The connector uses the HellermannTyton Keystone RJ45 Modular Jack which incorporates a cable management clip for rear strain relief and a clear wire colouring and numbering label to ensure error free termination.

Tested to exceed all ISO/IEC 11801 and ANSI/TIA/EIA 568-C.2 Category 5e performance standards.

The Alpha Label software package, available for download at www.htdata.co.uk enables straightforward port labelling.

Technical Drawings

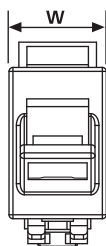

Front view of Category 5e angled 6C module

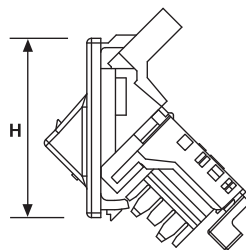

Side view of Category 5e angled 6C module

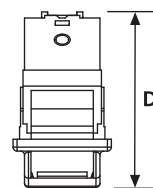

Top view of Category 5e angled 6C module



MegaBand Category 5e Single Outlet

Features and Benefits

- Exceeds Category 5e performance standards
- Low profile shallow depth (less than 25mm)
- Slide in labelling system
- Rear cable tie point



Low profile MegaBand Outlet offers exceptional Category 5e performance

Product Description

The MegaBand Outlet is designed to offer the user exceptional Category 5e performance and value.

The labelling window holds the slide-in-label in place whilst keeping dust and dirt away.

MegaBand Outlets fit into the single and double gang face plates from HellermannTyton, providing an attractive high density, low profile solution.

Technical Data Table

Article-No.	Type	Performance Category	Height (H)	Width (W)	Depth (D)	Colour
852-10010	MB08IDCC5E/WH	Category 5E (Class D)	50.0	25.0	24.0	White (WH)

All dimensions in mm. Subject to technical changes.

Technical Description

The MegaBand Category 5e outlet is available in industry standard Easy Clip mounting size, compatible with MegaBand and Easy Clip face plates.

The outlet circuit board interconnects the high performance RJ45 Jack to the IDC blocks, providing performance which when installed with HellermannTyton's Category 5e cable easily exceeds the Category 5e performance standards.

The PCB module is mounted in a plastic carrier with a rear clip. A label showing the colour code is mounted on the rear IDC assembly.

Each outlet can be identified using the slide in label system. The Alpha Label software package, available for download at www.htdata.co.uk enables straightforward port labelling.

Technical Drawings

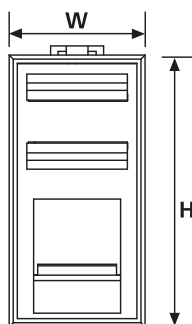

Front view of Category 5e MegaBand module

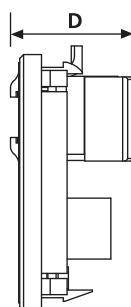

Side view of Category 5e MegaBand module

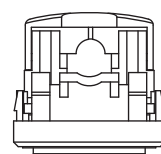

Top view of Category 5e MegaBand module



Keystone Jacks

Category 5e Jacks

Features and Benefits

- Exceeds Category 5e performance standards
- Industry standard modular 'Keystone' dimensions
- Rear cable tie point
- 110 IDC termination
- 12 coloured Jack options
- Palm tool for easy on site installation
- 568A and 568B wiring options



Category 5e Keystone Jacks available in 12 colours



Product Description

The Category 5e modular Keystone Jack offers exceptional performance that will support Gigabit Ethernet and 622 Mbps ATM applications with complete reliability.

Available in Black (BLK), Blue (BLU), Brown (BRN), Green (GRN), Grey (GRY), Ivory (I), Office White (FW), White (W), Yellow (YEL), Orange (ORN), Red (RED), Violet (VIO). Bulk packs of 50 Keystone Jacks available on request.

Technical Data Table

Article-No.	Type	Performance Category	Height (H)	Width (W)	Depth (D)	Port count	Quantity	Colour
852-25036	RJ45FC5E-BLK	Category 5E (Class D)	23.0	19.0	42.0	1	1	Black (BK)
852-25037	RJ45FC5E-BLU	Category 5E (Class D)	23.0	19.0	42.0	1	1	Blue (BU)
852-25040	RJ45FC5E-BRN	Category 5E (Class D)	23.0	19.0	42.0	1	1	Brown (BN)
852-25044	RJ45FC5E-FW	Category 5E (Class D)	23.0	19.0	42.0	1	1	Office White (OEWH)
852-25045	RJ45FC5E-GRN	Category 5E (Class D)	23.0	19.0	42.0	1	1	Green (GN)
852-25046	RJ45FC5E-GRY	Category 5E (Class D)	23.0	19.0	42.0	1	1	Grey (GY)
852-25047	RJ45FC5E-I	Category 5E (Class D)	23.0	19.0	42.0	1	1	Ivory (IV)
852-25048	RJ45FC5E-ORN	Category 5E (Class D)	23.0	19.0	42.0	1	1	Orange (OG)
852-25049	RJ45FC5E-RED	Category 5E (Class D)	23.0	19.0	42.0	1	1	Red (RD)
852-25059	RJ45FC5E-VIO	Category 5E (Class D)	23.0	19.0	42.0	1	1	Violet (VT)
852-25060	RJ45FC5E-W	Category 5E (Class D)	23.0	19.0	42.0	1	1	White (WH)
852-25061	RJ45FC5E-YEL	Category 5E (Class D)	23.0	19.0	42.0	1	1	Yellow (YE)

All dimensions in mm. Subject to technical changes.

Technical Description

The Category 5e Jack meets and exceeds the requirements of ANSI/TIA/EIA 568-C.2 and can support Gigabit Ethernet applications.

Adapters are available to enable the Keystone Jack to be assembled with the GigaBand/Alpha Snap shuttered Outlet and 6C angled module.

Technical Drawings

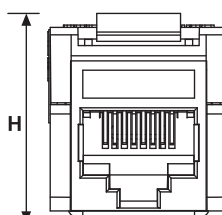

Front view of Category 5e Keystone Jack

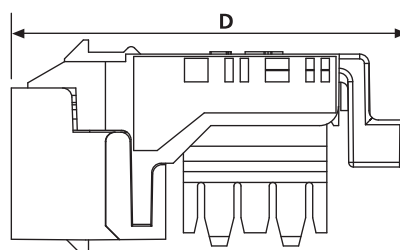

Side view of Category 5e Keystone Jack

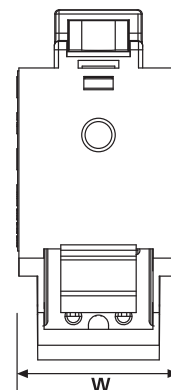

Top view of Category 5e Keystone Jack



Alpha Snap Shielded Category 5e Single Outlet

Features and Benefits

- Shielded Jack
- Fully modular PCB
- Exceeds Category 5e performance standards
- Patented slide label system and software
- 568A or 568B wiring options
- Module colour options available
- Rear cable tie point

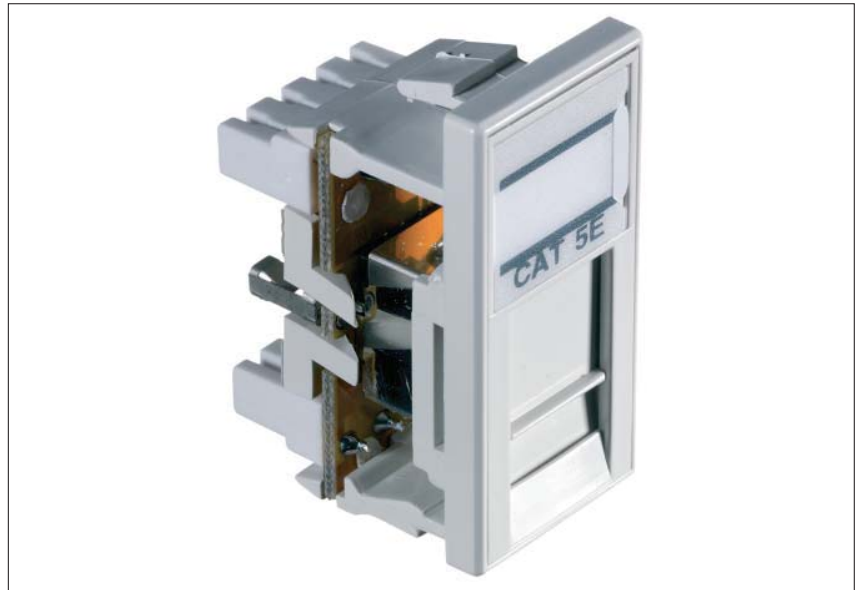

Shielded outlet exceeds Category 5e performance standards

Product Description

Alpha Snap is the leading Category 5e product group within the HellermannTyton cabling system product range. Designed to offer exceptional Category 5e performance and to meet the exacting standards of mission critical installations.

The Alpha Snap Shielded Outlet is available in standard single (25mm x 50mm) format.

Technical Data Table

Article-No.	Type	Performance Category	Height (H)	Width (W)	Depth (D)	Colour
852-05275	AS08PBC5ESLD/WH	Category 5E (Class D)	50.0	25.0	34.0	White (WH)

All dimensions in mm. Subject to technical changes.

Technical Description

The Alpha Snap Outlet is available in both proprietary HellermannTyton (Alpha Snap) and industry standard (Easy Clip) mounting sizes.

Tested to exceed all ISO/IEC 11801 and ANSI/TIA/EIA 568-C.2 Category 5e performance standards the Alpha Snap Outlet offers backward compatibility with Category 5 and voice products.

The Alpha Label software package, available for download at www.htdata.co.uk enables straightforward port labelling.

Technical Drawings

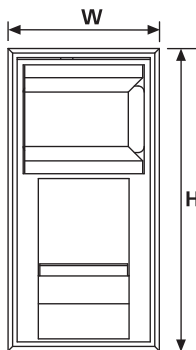

Front view of Category 5e Alpha Snap shielded module

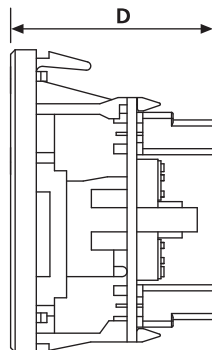

Side view of Category 5e Alpha Snap shielded module

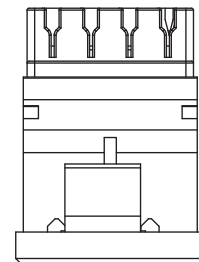

Top view of Category 5e Alpha Snap shielded module



Alpha Snap Shielded Category 5e Coloured Outlets

Features and Benefits

- Shielded Jack
- Fully modular PCB
- Exceeds Category 5e performance standards
- Patented slide label system and software
- 568A or 568B wiring options
- Module colour options available
- Rear cable tie point



Coloured Alpha Snap Category 5e Outlets

Product Description

Alpha Snap is the leading Category 5e product group within the HellermannTyton cabling system product range. Designed to offer exceptional Category 5e performance and to meet the exacting standards of mission critical installations.

The Alpha Snap Shielded Coloured Outlet is available in Black (BK), Blue (BL), Green (GN) and Red (RD).

The Alpha Snap Shielded Outlet is available in standard single (25mm x 50mm) format.

Technical Data Table

Article-No.	Type	Performance Category	Height (H)	Width (W)	Depth (D)	Port count	Colour
852-05607	AS08PBC5ESLD/BK	Category 5E (Class D)	50.0	25.0	34.0	1	Black (BK)
852-05608	AS08PBC5ESLD/BL	Category 5E (Class D)	50.0	25.0	34.0	1	Blue (BU)
852-05609	AS08PBC5ESLD/GN	Category 5E (Class D)	50.0	25.0	34.0	1	Green (GN)
852-05610	AS08PBC5ESLD/RD	Category 5E (Class D)	50.0	25.0	34.0	1	Red (RD)

All dimensions in mm. Subject to technical changes.

Technical Description

Alpha Snap Shielded Coloured Outlets are only available in proprietary HellermannTyton (Alpha Snap) mounting size.

Tested to exceed all ISO/IEC 11801 and ANSI/TIA/EIA 568-C.2 Category 5e performance standards the Alpha Snap Outlet offers backward compatibility with Category 5 and voice products.

The Alpha Label software package, available for download at www.htdata.co.uk enables straightforward port labelling.

Technical Drawings

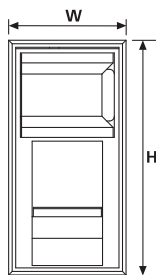

Front view of Category 5e Alpha Snap shielded module

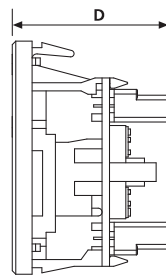

Side view of Category 5e Alpha Snap shielded module

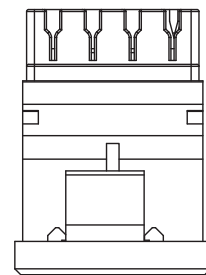

Top view of Category 5e Alpha Snap shielded module



Easy Clip Shielded Category 5e Single Outlet

Features and Benefits

- Shielded Jack
- Fully modular PCB
- Exceeds category 5e performance standards
- Patented slide label system and software
- 568A or 568B wiring options
- Black and white options available
- Rear cable tie point



Easy Clip Category 5e Outlets available in black and white

Product Description

Alpha Snap is the leading Category 5e product group within the HellermannTyton cabling system. Designed to offer exceptional Category 5e performance and to meet the exacting standards of mission critical installations.

The Alpha Snap Shielded Outlet is available in standard single (25mm x 50mm) format.

Technical Data Table

Article-No.	Type	Performance Category	Height (H)	Width (W)	Depth (D)	Port count	Quantity	Colour
852-05613	EC08KBC5ESLD/BK	Category 5E (Class D)	50.0	25.0	34.0	1	1	Black (BK)
852-05612	EC08KBC5ESLD/WH	Category 5E (Class D)	50.0	25.0	34.0	1	1	White (WH)

All dimensions in mm. Subject to technical changes.

Technical Description

The Alpha Snap Outlet is available in both proprietary HellermannTyton (Alpha Snap) and industry standard (Easy Clip) mounting sizes.

Tested to exceed all ISO/IEC 11801 and ANSI/TIA/EIA 568-C.2 Category 5e performance standards the Alpha Snap Outlet offers backward compatibility with Category 5 and voice products.

The Alpha Label software package, available for download at www.htdata.co.uk enables straightforward port labelling.

Technical Drawings

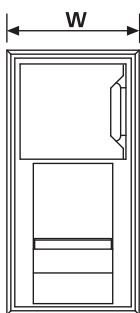

Front view of Category 5e Easy Clip shielded module

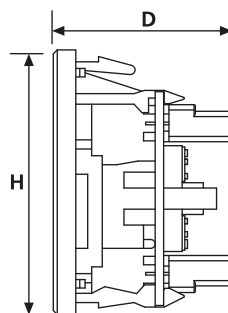

Side view of Category 5e Easy Clip shielded module

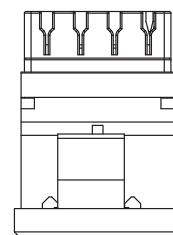

Top view of Category 5e Easy Clip shielded module



Keystone Jacks

Category 3 Jacks

3

Features and Benefits

- Industry standard modular 'Keystone' dimensions
- Rear cable tie point
- 110 IDC termination
- 12 coloured jack options
- Palm tool for easy on site installation
- 568A and 568B wiring options



Designed to give maximum performance in Category 3 applications

Product Description

Offered in 3 styles, HellermannTyton's Category 3 modular Keystone Jacks are designed to give the maximum performance in Category 3 applications.

Available in Black (BLK), Blue (BLU), Brown (BRN), Green (GRN), Grey (GRY), Ivory (I), Office White (FW), White (W), Yellow (YEL), Orange (ORN), Red (RED), Violet (VIO). Bulk packs of 50 Keystone Jacks available on request.

Technical Data Table

Article-No.	Type	Performance Category	Height (H)	Width (W)	Depth (D)	Port count	Quantity	Colour
852-25016	RJ45FC3-BLK	Category 3 (Class C)	23.0	19.0	42.0	1	1	Black (BK)
852-25017	RJ45FC3-BLU	Category 3 (Class C)	23.0	19.0	42.0	1	1	Blue (BU)
852-25018	RJ45FC3-BRN	Category 3 (Class C)	23.0	19.0	42.0	1	1	Brown (BN)
852-25020	RJ45FC3-FW	Category 3 (Class C)	23.0	19.0	42.0	1	1	Office White (OEWH)
852-25021	RJ45FC3-GRN	Category 3 (Class C)	23.0	19.0	42.0	1	1	Green (GN)
852-25022	RJ45FC3-GRY	Category 3 (Class C)	23.0	19.0	42.0	1	1	Grey (GY)
852-25023	RJ45FC3-I	Category 3 (Class C)	23.0	19.0	42.0	1	1	Ivory (IV)
852-25024	RJ45FC3-ORN	Category 3 (Class C)	23.0	19.0	42.0	1	1	Orange (OG)
852-25025	RJ45FC3-RED	Category 3 (Class C)	23.0	19.0	42.0	1	1	Red (RD)
852-25026	RJ45FC3-VIO	Category 3 (Class C)	23.0	19.0	42.0	1	1	Violet (VT)
852-25027	RJ45FC3-W	Category 3 (Class C)	23.0	19.0	42.0	1	1	White (WH)
852-25028	RJ45FC3-YEL	Category 3 (Class C)	23.0	19.0	42.0	1	1	Yellow (YE)

All dimensions in mm. Subject to technical changes.

Technical Description

Category 3 Keystone Jacks are available in a 6 & 8 positions/6 & 8 conductors 568A/B connector or USOC connector. The 6 position jack can be wired in a RJ11C (1 pair), RJ14C (2 pair), or RJ25 (3 pair) configuration.

Adapters are available to enable the Keystone Jack to be assembled with the GigaBand/Alpha Snap Shuttered Outlet and 6C Angled module.

Technical Drawings

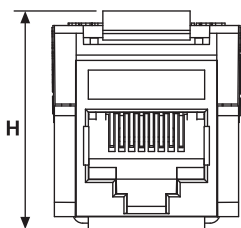

Front view of Category 3 Keystone RJ45 Jack

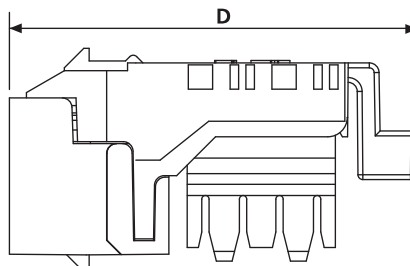

Side view of Category 3 Keystone RJ45 Jack

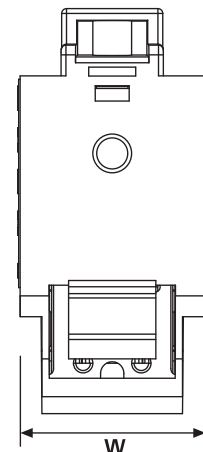

Top view of Category 3 Keystone RJ45 Jack



	Page
4.1 Fibre Adaptors	
Multimode LC Quad Adaptor	128
Single Mode LC Quad Adaptor	128
Multimode LC Duplex Adaptor	129
Single Mode LC Duplex Adaptor	129
Multimode SC Duplex Adaptor	130
Single Mode SC Duplex Adaptor	130
Multimode SC Simplex Adaptor	131
Single Mode SC Simplex Adaptor	131
4.2 Fibre Connectors	
Multimode LC Duplex Connector	132
Single Mode LC Duplex Connector	132
Multimode LC Simplex Connector	133
Single Mode LC Simplex Connector	133
Multimode SC Duplex Connector	134
Single Mode SC Duplex Connector	134
Multimode SC Simplex Connector	135
Single Mode SC Simplex Connector	135
4.3 Fibre Pigtails	
LC Pigtails	136
SC Pigtails	136

	Page
4.4 Fibre Fan Outs	
OM4 Multimode 24 Core MTP to LC Fan Out	137
OM3 Multimode 24 Core MTP to LC Fan Out	137
OS1 Single Mode 24 Core MTP to LC Fan Out	138
OM4 Multimode 12 Core MTP to LC Fan Out	138
OM3 Multimode 12 Core MTP to LC Fan Out	139
OS1 Single Mode 12 Core MTP to LC Fan Out	139
Multimode LC to LC Fan Out	140
Single Mode LC to LC Fan Out	140
Multimode SC to SC Fan Out	141
Single Mode SC to SC Fan Out	141
4.5 RapidNet MTP Back-Bone Cables	
OM4 Multimode 24 Core MTP	142
OM3 Multimode 24 Core MTP	142
OS1 Multimode 24 Core MTP	143
OM4 Multimode 12 Core MTP	143
OM3 Multimode 12 Core MTP	144
OS1 Single Mode 12 Core MTP	144
4.6 Fibre Panels	
LC Multimode Panel	145
LC Single Mode Panel	145
SC Multimode Panel	146
SC Single Mode Panel	146



Fibre Adaptors

Multimode LC Quad Adaptor

Features and Benefits

- High performance Multimode Quad Adaptor
- Compatible with fibre panels from HellermannTyton
- A fully populated panel offers up to 96 LC fibres in 1U of space
- Quad Adaptor accepts four LC Connectors

Product Description

The fibre adaptor is used to mate two connectors together, usually mounted in a distribution panel or wall box. In most cases it is the critical part of the system that aligns the ferrule of the connectors keeping the fibres in perfect alignment and minimising losses.

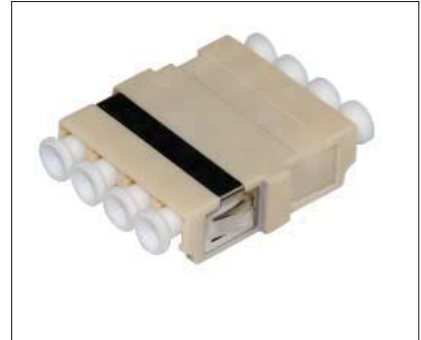

4 port Quad LC Multimode Adaptor, compatible with HellermannTyton Fibre Panels

Technical Data Table

Article-No.	Type	Performance Category	Port count	Colour
855-20041	FBAMMBG-LCLCQD-FL001	Multimode	4	Beige (BGE)

All dimensions in mm. Subject to technical changes.

Technical Description

The LC Adaptor sets the standard for small optical fibre inter-connects. With its simple to use latched lever locking mechanism preventing

accidental disconnection and precision housing for optimum performance.

Fibre Adaptors

Single Mode LC Quad Adaptor

Features and Benefits

- High performance Single Mode Quad Adaptor
- Compatible with fibre panels from HellermannTyton
- A fully populated panel offers up to 96 LC fibres in 1U of space
- Quad Adaptor accepts four LC Connectors

Product Description

The fibre adaptor is used to mate two connectors together, usually mounted in a distribution panel or wall box. In most cases it is the critical part of the system that aligns the ferrule of the connectors keeping the fibres in perfect alignment and minimising losses.

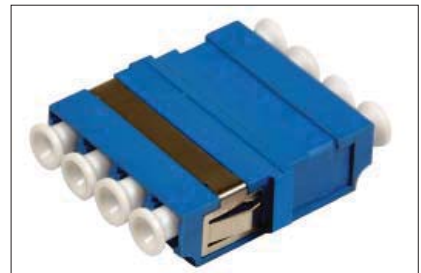

4 port Quad LC Single Mode Adaptor, compatible with HellermannTyton Fibre Panels

Technical Data Table

Article-No.	Type	Performance Category	Port count	Colour
855-20042	FBASMBL-LCLCQD-FL001	Single Mode	4	Blue (BU)

All dimensions in mm. Subject to technical changes.

Technical Description

The LC Adaptor sets the standard for small optical fibre inter-connects. With its simple to use latched lever locking mechanism preventing

accidental disconnection and precision housing for optimum performance.



Fibre Adaptors

Multimode LC Duplex Adaptor

Features and Benefits

- High performance Multimode Duplex Adaptor
- Compatible with fibre panels from HellermannTyton
- A fully populated panel offers up to 48 LC fibres in 1U of space
- Duplex Adaptor accepts two LC Connectors

Product Description

The fibre adaptor is used to mate two connectors together, usually mounted in a distribution panel or wall box. In most cases it is the critical part of the system that aligns the ferrule of the connectors keeping the fibres in perfect alignment and minimising losses.



LC Multimode Duplex Adaptor

Technical Data Table

Article-No.	Type	Performance Category	Port count	Colour
855-10049	FBAMMBG-LCLCDX-FL001	Multimode	2	Beige (BGE)

All dimensions in mm. Subject to technical changes.

Technical Description

The LC Adaptor sets the standard for small optical fibre inter-connects. With its simple to use latched lever locking mechanism preventing

accidental disconnection and precision housing for optimum performance.

Fibre Adaptors

Single Mode LC Duplex Adaptor

Features and Benefits

- High performance Single Mode Duplex Adaptor
- Compatible with fibre panels from HellermannTyton
- A fully populated panel offers up to 48 LC fibres in 1U of space
- Duplex Adaptor accepts two LC Connectors

Product Description

The fibre adaptor is used to mate two connectors together, usually mounted in a distribution panel or wall box. In most cases it is the critical part of the system that aligns the ferrule of the connectors keeping the fibres in perfect alignment and minimising losses.

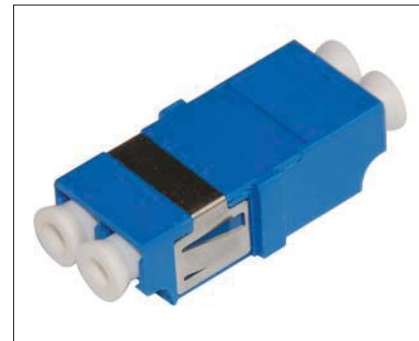

2 port LC Duplex Single Mode Adaptor, compatible with HellermannTyton Fibre Panels

Technical Data Table

Article-No.	Type	Performance Category	Port count	Colour
855-20055	FBASMBL-LCLCDX-FL001	Single Mode	2	Blue (BU)

All dimensions in mm. Subject to technical changes.

Technical Description

The LC Adaptor sets the standard for small optical fibre inter-connects. With its simple to use latched lever locking mechanism preventing

accidental disconnection and precision housing for optimum performance.



Fibre Adaptors

Multimode SC Duplex Adaptor

Features and Benefits

- High performance Multimode Duplex Adaptor
- Compatible with fibre panels from HellermannTyton
- A fully populated panel offers up to 48 SC fibres in 1U of space
- Duplex Adaptor accepts two SC Connectors

Product Description

The fibre adaptor is used to mate two connectors together, usually mounted in a distribution panel or wall box. In most cases it is the critical part of the system that aligns the ferrule of the connectors keeping the fibres in perfect alignment and minimising losses.

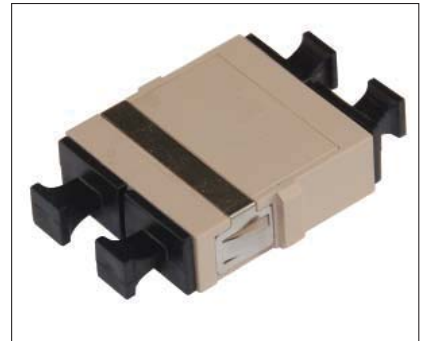

2 port SC Duplex Multimode Adaptor, compatible with HellermannTyton Fibre Panels

Technical Data Table

Article-No.	Type	Performance Category	Port count	Colour
855-10055	FBAMMBG-SCSCDX-FL001	Multimode	2	Beige (BGE)

All dimensions in mm. Subject to technical changes.

Technical Description

The SC Adaptor is a proven design used in modern optical fibre systems. With the audible click mechanism and full proof design this connector provides a secure inter-connect.

Fibre Adaptors

Single Mode SC Duplex Adaptor

Features and Benefits

- High performance Single Mode Duplex Adaptor
- Compatible with fibre panels from HellermannTyton
- A fully populated panel offers up to 48 SC fibres in 1U of space
- Duplex Adaptor accepts two SC Connectors

Product Description

The fibre adaptor is used to mate two connectors together, usually mounted in a distribution panel or wall box. In most cases it is the critical part of the system that aligns the ferrule of the connectors keeping the fibres in perfect alignment and minimising losses.



2 port SC Duplex Single Mode Adaptor, compatible with HellermannTyton Fibre Panels

Technical Data Table

Article-No.	Type	Performance Category	Port count	Colour
855-10054	FBASMBL-SCSCDX-FL001	Single Mode	2	Blue (BU)

All dimensions in mm. Subject to technical changes.

Technical Description

The SC Adaptor is a proven design used in modern optical fibre systems. With the audible click mechanism and full proof design this connector provides a secure inter-connect.



Fibre Adaptors

Multimode SC Simplex Adaptor

Features and Benefits

- High performance Multimode Simplex Adaptor
- Compatible with fibre panels from HellermannTyton
- A fully populated panel offers up to 24 SC fibres in 1U of space
- Simplex Adaptor accepts one SC Connector

Product Description

The fibre adaptor is used to mate two connectors together, usually mounted in a distribution panel or wall box. In most cases it is the critical part of the system that aligns the ferrule of the connectors keeping the fibres in perfect alignment and minimising losses.



SC Simplex Multimode Adapter, compatible with HellermannTyton Fibre Panels

Technical Data Table

Article-No.	Type	Performance Category	Port count	Colour
855-20030	FBAMMBG-SCSCSX-FL001	Multimode	1	Beige (BGE)

All dimensions in mm. Subject to technical changes.

Technical Description

The SC Adaptor is a proven design used in modern optical fibre systems. With the audible click mechanism and full proof design this connector provides a secure inter-connect.

Fibre Adaptors

Single Mode SC Simplex Adaptor

Features and Benefits

- High performance Single Mode Simplex Adaptor
- Compatible with fibre panels from HellermannTyton
- A fully populated panel offers up to 24 SC fibres in 1U of space
- Simplex Adaptor accepts one SC Connector

Product Description

The fibre adaptor is used to mate two connectors together, usually mounted in a distribution panel or wall box. In most cases it is the critical part of the system that aligns the ferrule of the connectors keeping the fibres in perfect alignment and minimising losses.



SC Simplex Single Mode Adapter, compatible with HellermannTyton Fibre Panels

Technical Data Table

Article-No.	Type	Performance Category	Port count	Colour
855-20031	FBASMBL-SCSCSX-FL001	Single Mode	1	Blue (BU)

All dimensions in mm. Subject to technical changes.

Technical Description

The SC Adaptor is a proven design and used in modern optical fibre systems. With the audible click mechanism and full proof design this connector provides a secure inter-connect.



Fibre Connectors

Multimode LC Duplex Connector

Features and Benefits

- Features a latched lever mechanism to provide secure mating into the adaptor
- Uses half the space of the SC Connector
- Connectors supplied in separate bags
- Available with 3.0mm boot

Product Description

The LC Connector is now used extensively in the local area network as a standard fitting for many market leading hubs and switches. The LC is the standard for small form factor connectors.



LC Multimode Duplex Connector available with 3.0mm boot

Technical Data Table

Article-No.	Type	Performance Category	Port count	Colour
855-10041	FBCMMBG-LCXXDX-3.0WH	Multimode	2	Beige (BGE)

All dimensions in mm. Subject to technical changes.

Technical Description

Multimode LC Connectors are supplied in individual bags including the connector, dust cover and a 3.0mm boot. All connectors comply with the IEC874-14 standard ensuring interoperability.

Fibre Connectors

Single Mode LC Duplex Connector

Features and Benefits

- Features a latched lever mechanism to provide secure mating into the adaptor
- Uses half the space of the SC Connector
- Connectors supplied in separate bags
- Available with 3.0mm boot

Product Description

The LC Connector is now used extensively in the local area network as a standard fitting for many market leading hubs and switches. The LC is the standard for small form factor connectors.



LC Single Mode Duplex Connector available with 3.0mm boot

Technical Data Table

Article-No.	Type	Performance Category	Port count	Colour
855-10053	FBCSMBL-LCXXDX-3.0WH	Single Mode	2	Blue (BU)

All dimensions in mm. Subject to technical changes.

Technical Description

Single Mode LC Connectors are supplied in individual bags including the connector, dust cover and a 3.0mm boot. All connectors comply with the IEC874-14 standard ensuring interoperability.



Fibre Connectors

Multimode LC Simplex Connector

Features and Benefits

- Features a latched lever mechanism to provide secure mating into the adaptor
- Uses half the space of the SC Connector
- Connectors supplied in separate bags
- Available with 0.9mm or 3.0mm boot

Product Description

The LC Connector is now used extensively in the local area network as a standard fitting for many market leading hubs and switches. The LC is the standard for small form factor connectors.



LC Multimode Simplex Connector available with 3.0mm and 0.9mm boots

Technical Data Table

Article-No.	Type	Performance Category	Port count	Colour
855-10011	FBCMMBG-LCXXSX-0.9WH	Multimode	1	Beige (BGE)
855-10026	FBCMMBG-LCXXSX-3.0WH	Multimode	1	Beige (BGE)

All dimensions in mm. Subject to technical changes.

Technical Description

Multimode LC Connectors are supplied in individual bags including the connector, dust cover and a 3.0mm or 0.9mm boot. All connectors comply with the IEC874-14 standard ensuring interoperability.

Fibre Connectors

Single Mode LC Simplex Connector

Features and Benefits

- Features a latched lever mechanism to provide secure mating into the adaptor
- Uses half the space of the SC Connector
- Connectors supplied in separate bags
- Available with 0.9mm or 3.0mm boot

Product Description

The LC Connector is now used extensively in the local area network as a standard fitting for many market leading hubs and switches. The LC is the standard for small form factor connectors.



LC Single Mode Simplex Connector available with 3.0mm and 0.9mm boots

Technical Data Table

Article-No.	Type	Performance Category	Port count	Colour
855-10012	FBCSMBL-LCXXSX-0.9WH	Single Mode	1	Blue (BU)
855-10052	FBCSMBL-LCXXSX-3.0WH	Single Mode	1	Blue (BU)

All dimensions in mm. Subject to technical changes.

Technical Description

Single Mode LC Connectors are supplied in individual bags including the connector, dust cover and a 3.0mm or 0.9mm boot. All connectors comply with the IEC874-14 standard ensuring interoperability.



Fibre Connectors

Multimode SC Duplex Connector

Features and Benefits

- Features keyed connector to ensure secure mating into the adaptor
- Suitable for 2-3mm cables
- Connectors supplied in separate bags
- Available with 3.0mm boot

Product Description

The SC Connector is a proven design and is widely used in fibre optic systems. The connectors are keyed to ensure correct orientation on insertion.



SC Multimode Duplex Connectors

Technical Data Table

Article-No.	Type	Performance Category	Port count	Colour
855-10051	FBCMMBG-SCXXDX-3.0MX	Multimode	2	Beige (BGE)

All dimensions in mm. Subject to technical changes.

Technical Description

Multimode SC Connectors are supplied in individual bags including the connector, dust cover and a 3.0mm boot. All connectors comply with the IEC874-14 standard ensuring interoperability.

Fibre Connectors

Single Mode SC Duplex Connector

Features and Benefits

- Features keyed connector to ensure secure mating into the adaptor
- Suitable for 2-3mm cables
- Connectors supplied in separate bags
- Available with 3.0mm boot

Product Description

The SC Connector is a proven design and is widely used in fibre optic systems. The connectors are keyed to ensure correct orientation on insertion.

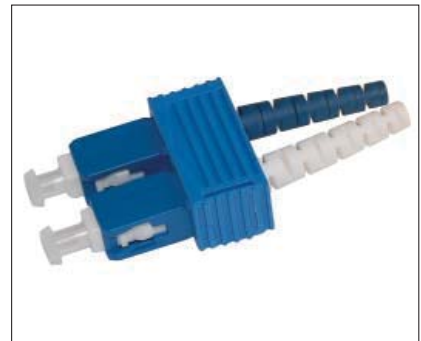

SC Duplex Single Mode Connectors

Technical Data Table

Article-No.	Type	Performance Category	Port count	Colour
855-14222	FBCSMBL-SCXXDX-3.0MX	Single Mode	2	Blue (BU)

All dimensions in mm. Subject to technical changes.

Technical Description

Single Mode SC Connectors are supplied in individual bags including the connector, dust cover and a 3.0mm boot. All connectors comply with the IEC874-14 standard ensuring interoperability.



Fibre Connectors

Multimode SC Simplex Connector

Features and Benefits

- Features keyed connector to ensure secure mating into the adaptor
- Suitable for 2-3mm cables
- Connectors supplied in separate bags
- Available with 0.9mm or 3.0mm boot

Product Description

The SC Connector is a proven design and is widely used in fibre optic systems. The connectors are keyed to ensure correct orientation on insertion.



SC Multimode Simplex Connectors

Technical Data Table

Article-No.	Type	Performance Category	Port count	Colour
855-10032	FBCMMBG-SCXXSX-0.9WH	Multimode	1	Beige (BGE)
855-10029	FBCMMBG-SCXXSX-3.0WH	Multimode	1	Beige (BGE)

All dimensions in mm. Subject to technical changes.

Technical Description

Multimode SC Connectors are supplied in individual bags including the connector, dust cover and a 3.0mm or 0.9mm boot. All connectors comply with the IEC874-14 standard ensuring interoperability.

Fibre Connectors

Single Mode SC Simplex Connector

Features and Benefits

- Features keyed connector to ensure secure mating into the adaptor
- Suitable for 2-3mm cables
- Connectors supplied in separate bags
- Available with 0.9mm or 3.0mm boot

Product Description

The SC Connector is a proven design and is widely used in fibre optic systems. The connectors are keyed to ensure correct orientation on insertion.



SC Single Mode Simplex Connectors

Technical Data Table

Article-No.	Type	Performance Category	Port count	Colour
855-10045	FBCSMBL-SCXXSX-0.9WH	Single Mode	1	Blue (BU)
855-10046	FBCSMBL-SCXXSX-3.0WH	Single Mode	1	Blue (BU)

All dimensions in mm. Subject to technical changes.

Technical Description

Single Mode SC Connectors are supplied in individual bags including the connector, dust cover and a 3.0mm or 0.9mm boot. All connectors comply with the IEC874-14 standard ensuring interoperability.



Fibre Pigtails

LC Pigtails

Features and Benefits

- Available in single mode and multimode
- LC and SC Connectors
- Manufactured to ISO standards
- Pre-terminated connector saves installation time on site
- Standard length 1m

Product Description

LC Pigtails are available in both single mode and multimode and are supplied in standard lengths of 1m. Other lengths and fibre types can be supplied on request.

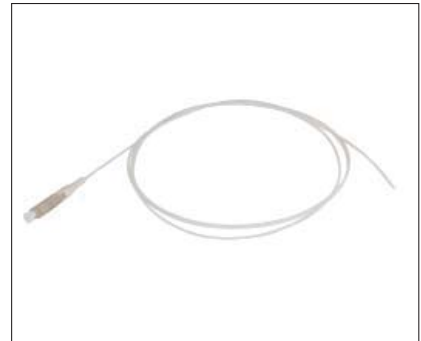

LC Fibre Pigtails

Technical Data Table

Article-No.	Type	Performance Category	Length (L)	Port count	Colour
855-25033	FBTXOM3-LCXXSW-01.0M	OM3 Multimode	1.0 m	1	Beige (BGE)
855-25009	FBTXOS1-LCXXSW-01.0M	OS1 Single Mode	1.0 m	1	Blue (BU)

All dimensions in mm. Subject to technical changes.

Technical Description

The LC Pigtail is designed to be spliced onto existing fibre cables, eliminating the need to polish fibre ends on site.

NB. OM3 and OS1 as standard. Other fibre types (OM4, OM2, OM1 and OS2) available on request.

Fibre Pigtails

SC Pigtails

Features and Benefits

- Available in single mode and multimode
- LC and SC Connectors
- Manufactured to ISO standards
- Pre-terminated connector saves installation time on site
- Standard length 1m

Product Description

SC Pigtails are available in both single mode and multimode and are supplied in standard lengths of 1m. Other lengths and fibre types can be supplied on request.

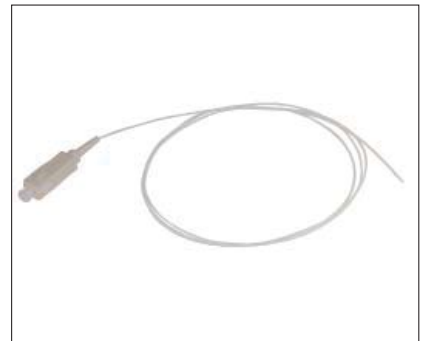

SC Fibre Pigtails

Technical Data Table

Article-No.	Type	Performance Category	Length (L)	Port count	Colour
855-25028	FBTXOM3-SCXXSW-01.0M	OM3 Multimode	1.0 m	1	Beige (BGE)
855-25017	FBTXOS1-SCXXSW-01.0M	OS1 Single Mode	1.0 m	1	Blue (BU)

All dimensions in mm. Subject to technical changes.

Technical Description

The SC Pigtail is designed to be spliced onto existing fibre cables, eliminating the need to polish fibre ends on site.

NB. OM3 and OS1 as standard. Other fibre types (OM4, OM2, OM1 and OS2) available on request.



RapidNet MTP Fan Out Cables OM4 Multimode 24 Core MTP to LC Fan Out

Features and Benefits

- High performance low loss Elite® Connectors from US Conec
- Compatible with all MTP RapidNet Cassettes
- Available in OM3, OM4 and OS1
- LC Fan Out ideal for inter-connect with active hardware
- Pre-tested with test results supplied

Product Description

The MTP to LC Fan Out is pre-terminated and pre-tested ensuring the highest performance. The MTP Connector is the low loss Elite® Connector from US Conec and is compatible with all RapidNet MTP Cassettes.

The LC Fan Out end provides 24 LC connectors, designed as a high performance inter-connect for any patching to active hardware equipment.

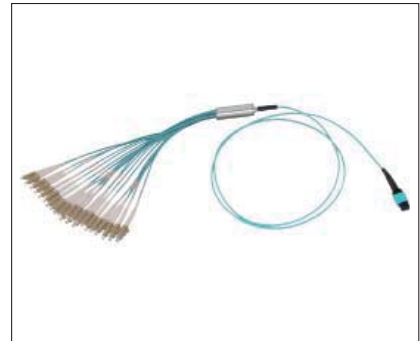

MTP 24 core LC Fan Out Cable ideal for high performance fibre patching

Technical Data Table

Article-No.	Type	Performance Category	Length (L)	Port count	Colour
860-00034	FLS24M4-MFLFDA-10.0M	OM4 Multimode	10.0 m	24	Aquamarine (AE)

All dimensions in mm. Subject to technical changes.

Technical Description

All MTP Connectors and adaptors are keyed so they connect in the correct orientation ensuring the correct polarity for the link. This helps to ensure that the installation is as quick and smooth as possible and error free.

The fan out unit includes integral strain relief and the furcation tubing on the individual fibres means that the breakout fibres can be used as a standard patch lead.

NB. Part numbers shown are for 10m length. Other lengths are available. The standard fan out breakout length is 0.5m for cable lengths between 2m to 5m and 1m for cable lengths over 5m.

RapidNet MTP Fan Out Cables OM3 Multimode 24 Core MTP to LC Fan Out

Features and Benefits

- High performance low loss Elite® Connectors from US Conec
- Compatible with all MTP RapidNet Cassettes
- Available in OM3, OM4 and OS1
- LC Fan Out ideal for inter-connect with active hardware
- Pre-tested with test results supplied

Product Description

The MTP to LC Fan Out is pre-terminated and pre-tested ensuring the highest performance. The MTP Connector is the low loss Elite® Connector from US Conec and is compatible with all RapidNet MTP Cassettes.

The LC Fan Out end provides 24 LC connectors, designed as a high performance inter-connect for any patching to active hardware equipment.

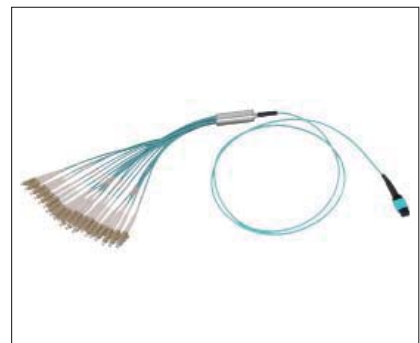

MTP 24 core LC Fan Out Cable ideal for high performance fibre patching

Technical Data Table

Article-No.	Type	Performance Category	Length (L)	Port count	Colour
860-00036	FLS24M3-MFLFDA-10.0M	OM3 Multimode	10.0 m	24	Aquamarine (AE)

All dimensions in mm. Subject to technical changes.

Technical Description

All MTP Connectors and adaptors are keyed so they connect in the correct orientation ensuring the correct polarity for the link. This helps to ensure that the installation is as quick and smooth as possible and error free.

The fan out unit includes integral strain relief and the furcation tubing on the individual fibres means that the breakout fibres can be used as a standard patch lead.

NB. Part numbers shown are for 10m length. Other lengths are available. The standard fan out breakout length is 0.5m for cable lengths between 2m to 5m and 1m for cable lengths over 5m.



RapidNet MTP Fan Out Cables OS1 Single Mode 24 Core MTP to LC Fan Out

Features and Benefits

- High performance connectors from US Conec
- Compatible with all MTP RapidNet Cassettes
- Available in OM3, OM4 and OS1
- LC Fan Out ideal for inter-connect with active hardware
- Pre-tested with test results supplied

Product Description

The MTP to LC Fan Out is pre-terminated and pre-tested ensuring the highest performance. The MTP Connector from US Conec is compatible with all RapidNet MTP Cassettes.

The LC Fan Out end provides 24 LC connectors, designed as a high performance inter-connect for any patching to active hardware equipment.

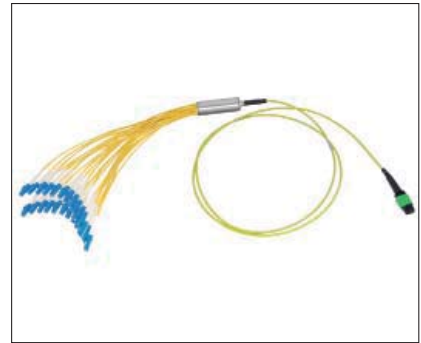

MTP 24 core LC Fan Out Cable ideal for high performance fibre patching

Technical Data Table

Article-No.	Type	Performance Category	Length (L)	Port count	Colour
860-00045	FLS24S1-MFLFDY-10.0M	OS1 Single Mode	10.0 m	24	Yellow (YE)

All dimensions in mm. Subject to technical changes.

Technical Description

All MTP Connectors and Adaptors are keyed so they connect in the correct orientation ensuring the correct polarity for the link. This helps to ensure that the installation is as quick and smooth as possible and error free.

The fan out unit includes integral strain relief and the furcation tubing on the individual fibres means that the breakout fibres can be used as a standard patch lead.

NB. Part numbers shown are for 10m length. Other lengths are available. The standard fan out breakout length is 0.5m for cable lengths between 2m to 5m and 1m for cable lengths over 5m.

RapidNet MTP Fan Out Cables OM4 Multimode 12 Core MTP to LC Fan Out

Features and Benefits

- High performance low loss Elite® Connectors from US Conec
- Compatible with all MTP RapidNet Cassettes
- Available in OM3, OM4 and OS1
- LC Fan Out ideal for inter-connect with active hardware
- Pre-tested with test results supplied

Product Description

The MTP to LC Fan Out is pre-terminated and pre-tested ensuring the highest performance. The MTP Connector is the low loss Elite® Connector from US Conec and is compatible with all RapidNet MTP Cassettes.

The LC Fan Out end provides 12 LC connectors, designed as a high performance inter-connect for any patching to active hardware equipment.



MTP 12 core LC Fan Out Cable ideal for high performance fibre patching

Technical Data Table

Article-No.	Type	Performance Category	Length (L)	Port count	Colour
860-00028	FLS12M4-MFLFDA-10.0M	OM4 Multimode	10.0 m	12	Aquamarine (AE)

All dimensions in mm. Subject to technical changes.

Technical Description

All MTP Connectors and Adaptors are keyed so they connect in the correct orientation ensuring the correct polarity for the link. This helps to ensure that the installation is as quick and smooth as possible and error free.

The fan out unit includes integral strain relief and the furcation tubing on the individual fibres means that the breakout fibres can be used as a standard patch lead.

NB. Part numbers shown are for 10m length. Other lengths are available. The standard fan out breakout length is 0.5m for cable lengths between 2m to 5m and 1m for cable lengths over 5m.



RapidNet MTP Fan Out Cables OM3 Multimode 12 Core MTP to LC Fan Out

Features and Benefits

- High performance low loss Elite® Connectors from US Conec
- Compatible with all MTP RapidNet Cassettes
- Available in OM3, OM4 and OS1
- LC Fan Out ideal for inter-connect with active hardware
- Pre-tested with test results supplied

Product Description

The MTP to LC Fan Out is pre-terminated and pre-tested ensuring the highest performance. The MTP Connector is the low loss Elite® Connector from US Conec and is compatible with all RapidNet MTP Cassettes.

The LC Fan Out end provides 12 LC connectors, designed as a high performance inter-connect for any patching to active hardware equipment.



MTP 12 core LC Fan Out Cable ideal for high performance fibre patching

Technical Data Table

Article-No.	Type	Performance Category	Length (L)	Port count	Colour
860-00030	FLS12M3-MFLFDA-10.0M	OM3 Multimode	10.0 m	12	Aquamarine (AE)

All dimensions in mm. Subject to technical changes.

Technical Description

All MTP Connectors and Adaptors are keyed so they connect in the correct orientation ensuring the correct polarity for the link. This helps to ensure that the installation is as quick and smooth as possible and error free.

The fan out unit includes integral strain relief and the furcation tubing on the individual fibres means that the breakout fibres can be used as a standard patch lead.

NB. Part numbers shown are for 10m length. Other lengths are available. The standard fan out breakout length is 0.5m for cable lengths between 2m to 5m and 1m for cable lengths over 5m.

RapidNet MTP Fan Out Cables OS1 Single Mode 12 Core MTP to LC Fan Out

Features and Benefits

- High performance low loss Elite® Connectors from US Conec
- Compatible with all MTP RapidNet Cassettes
- Available in OM3, OM4 and OS1
- LC Fan Out ideal for inter-connect with active hardware
- Pre-tested with test results supplied

Product Description

The MTP to LC Fan Out is pre-terminated and pre-tested ensuring the highest performance. The MTP Connector is the low loss Elite® Connector from US Conec and is compatible with all RapidNet MTP Cassettes.

The LC Fan Out end provides 12 LC connectors, designed as a high performance inter-connect for any patching to active hardware equipment.

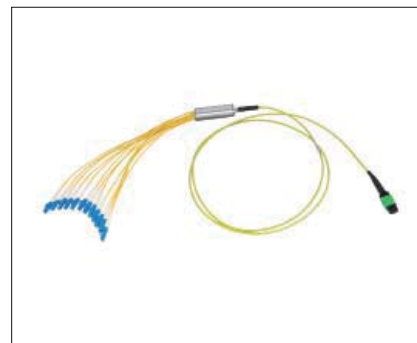

MTP 12 core LC Fan Out Cable ideal for high performance fibre patching

Technical Data Table

Article-No.	Type	Performance Category	Length (L)	Port count	Colour
860-00043	FLS12S1-MFLFDY-10.0M	OS1 Single Mode	10.0 m	12	Yellow (YE)

All dimensions in mm. Subject to technical changes.

Technical Description

All MTP Connectors and Adaptors are keyed so they connect in the correct orientation ensuring the correct polarity for the link. This helps to ensure that the installation is as quick and smooth as possible and error free.

The fan out unit includes integral strain relief and the furcation tubing on the individual fibres means that the breakout fibres can be used as a standard patch lead.

NB. Part numbers shown are for 10m length. Other lengths are available. The standard fan out breakout length is 0.5m for cable lengths between 2m to 5m and 1m for cable lengths over 5m.



Fibre Fan Outs

Multimode LC to LC Fan Out

Features and Benefits

- No fibre terminations on site
- Direct patching of equipment
- Metal fan out unit with integral cable strain relief for both distribution cable and single elements
- Simple neat patching solutions

Product Description

The LC to LC Fibre Fan Out to Fan Out cable is pre-terminated offering high performance multimode patching at both ends.

HellermannTyton are able to supply this fan out construction in a number of options from 12-144 core in OM4, OM3, OS1 and OS2.



Multimode 24 core LC Fan Out to LC Fan Out

Technical Data Table

Article-No.	Type	Performance Category	Length (L)	Port count	Colour
859-21024	RNFTD12-LFLFM3-10.0M	OM3 Multimode	10.0 m	12	Aquamarine (AE)
859-21266	RNFTD24-LFLFM3-10.0M	OM3 Multimode	10.0 m	24	Aquamarine (AE)
859-21267	RNFTD48-LFLFM3-10.0M	OM3 Multimode	10.0 m	48	Aquamarine (AE)
859-21269	RNFTD96-LFLFM3-10.0M	OM3 Multimode	10.0 m	96	Aquamarine (AE)
859-21270	RNFTDH4-LFLFM3-10.0M	OM3 Multimode	10.0 m	144	Aquamarine (AE)

All dimensions in mm. Subject to technical changes.

Technical Description

The cable being a multicore cable, is much smaller than the equivalent number of standard patch leads and therefore takes up less space in the trays and pathways. The fan out unit includes integral strain relief and the furcation tubing on the individual fibres means that the breakout fibres can be used as a standard patch lead.

NB. Part numbers shown are for 10m length. Other lengths are available. The standard fan out breakout length is 0.5m for cable lengths between 2m to 5m and 1m for cable lengths over 5m.

Fibre Fan Outs

Single Mode LC to LC Fan Out

Features and Benefits

- No fibre terminations on site
- Direct patching of equipment
- Metal fan out unit with integral cable strain relief for both distribution cable and single elements
- Simple neat patching solutions

Product Description

The LC to LC Fibre Fan Out to Fan Out cable is pre-terminated offering high performance single mode patching at both ends.

HellermannTyton are able to supply this fan out construction in a number of options from 12-144 core in OM4, OM3, OS1 and OS2.

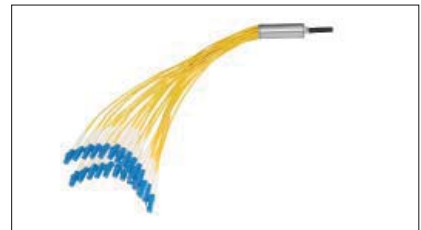

Single Mode 24 core LC Fan Out to LC Fan Out

Technical Data Table

Article-No.	Type	Performance Category	Length (L)	Port count	Colour
859-21302	RNFTD12-LFLFS1-10.0M	OS1 Single Mode	10.0 m	12	Yellow (YE)
859-21303	RNFTD24-LFLFS1-10.0M	OS1 Single Mode	10.0 m	24	Yellow (YE)
859-21304	RNFTD48-LFLFS1-10.0M	OS1 Single Mode	10.0 m	48	Yellow (YE)
859-21306	RNFTD96-LFLFS1-10.0M	OS1 Single Mode	10.0 m	96	Yellow (YE)
859-21307	RNFTDH4-LFLFS1-10.0M	OS1 Single Mode	10.0 m	144	Yellow (YE)

All dimensions in mm. Subject to technical changes.

Technical Description

The cable being a multicore cable, is much smaller than the equivalent number of standard patch leads and therefore takes up less space in the trays and pathways. The fan out unit includes integral strain relief and the furcation tubing on the individual fibres means that the breakout fibres can be used as a standard patch lead.

NB. Part numbers shown are for 10m length. Other lengths are available. The standard fan out breakout length is 0.5m for cable lengths between 2m to 5m and 1m for cable lengths over 5m.



Fibre Fan Outs

Multimode SC to SC Fan Out

Features and Benefits

- No fibre terminations on site
- Direct patching of equipment
- Metal fan out unit with integral cable strain relief for both distribution cable and single elements
- Simple neat patching solutions

Product Description

The SC to SC Fibre Fan Out to Fan Out cable is pre-terminated offering high performance multimode patching at both ends.

HellermannTyton are able to supply this fan out construction in a number of options from 12-144 core in OM4, OM3, OS1 and OS2.

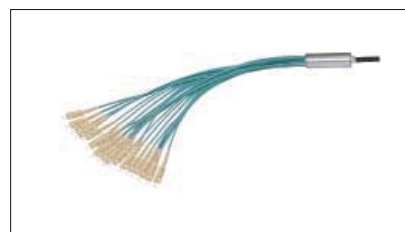

Multimode 24 core SC Fan Out to SC Fan Out

Technical Data Table

Article-No.	Type	Performance Category	Length (L)	Port count	Colour
859-21735	RNFTD12-SFSFM3-10.0M	OM3 Multimode	10.0 m	12	Aquamarine (AE)
859-21279	RNFTS24-SFSFM3-10.0M	OM3 Multimode	10.0 m	24	Aquamarine (AE)
859-21736	RNFTD48-SFSFM3-10.0M	OM3 Multimode	10.0 m	48	Aquamarine (AE)
859-21737	RNFTD96-SFSFM3-10.0M	OM3 Multimode	10.0 m	96	Aquamarine (AE)
859-21738	RNFTDH4-SFSFM3-10.0M	OM3 Multimode	10.0 m	144	Aquamarine (AE)

All dimensions in mm. Subject to technical changes.

Technical Description

The cable being a multicore cable, is much smaller than the equivalent number of standard patch leads and therefore takes up less space in the trays and pathways. The fan out unit includes integral strain relief and the furcation tubing on the individual fibres means that the breakout fibres can be used as a standard patch lead.

NB. Part numbers shown are for 10m length. Other lengths are available. The standard fan out breakout length is 0.5m for cable lengths between 2m to 5m and 1m for cable lengths over 5m.

Fibre Fan Outs

Single Mode SC to SC Fan Out

Features and Benefits

- No fibre terminations on site
- Direct patching of equipment
- Metal fan out unit with integral cable strain relief for both distribution cable and single elements
- Simple neat patching solutions

Product Description

The SC to SC Fibre Fan Out to Fan Out cable is pre-terminated offering high performance single mode patching at both ends.

HellermannTyton are able to supply this fan out construction in a number of options from 12-144 core in OM4, OM3, OS1 and OS2.

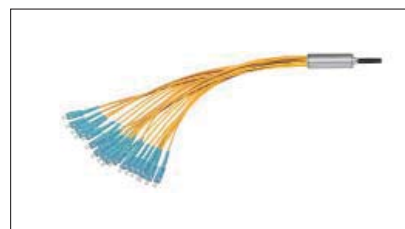

Single Mode 24 core SC Fan Out to SC Fan Out

Technical Data Table

Article-No.	Type	Performance Category	Length (L)	Port count	Colour
859-21739	RNFTD12-SFSFS1-10.0M	OS1 Single Mode	10.0 m	12	Yellow (YE)
859-21315	RNFTS24-SFSFS1-10.0M	OS1 Single Mode	10.0 m	24	Yellow (YE)
859-21740	RNFTD48-SFSFS1-10.0M	OS1 Single Mode	10.0 m	48	Yellow (YE)
859-21741	RNFTD96-SFSFS1-10.0M	OS1 Single Mode	10.0 m	96	Yellow (YE)
859-21742	RNFTDH4-SFSFS1-10.0M	OS1 Single Mode	10.0 m	144	Yellow (YE)

All dimensions in mm. Subject to technical changes.

Technical Description

The cable being a multicore cable, is much smaller than the equivalent number of standard patch leads and therefore takes up less space in the trays and pathways. The fan out unit includes integral strain relief and the furcation tubing on the individual fibres means that the breakout fibres can be used as a standard patch lead.

NB. Part numbers shown are for 10m length. Other lengths are available. The standard fan out breakout length is 0.5m for cable lengths between 2m to 5m and 1m for cable lengths over 5m.



RapidNet MTP Back-Bone Cables OM4 Multimode 24 Core MTP

Features and Benefits

- High performance low loss Elite® Connectors from US Conec
- Compatible with all MTP RapidNet Cassettes
- Available in OM3, OM4 and OS1
- Can be used as back-bone fibre link or MTP Patch Lead
- Pre-tested with test results supplied

Product Description

The MTP Back-Bone cable is pre-terminated and pre-tested ensuring the highest performance. The MTP Connector is the low loss Elite® Connector from US Conec and is compatible with all RapidNet MTP Cassettes.

The MTP Back-Bone cable can be used for high density patching between two MTP ports.



MTP Back-Bone cable with low loss Elite® Connectors from US Conec

Technical Data Table

Article-No.	Type	Performance Category	Length (L)	Colour
860-00008	FLX24M4-MFMFXA-10.0M	OM4 Multimode	10.0	Aquamarine (AE)

All dimensions in mm. Subject to technical changes.

Technical Description

US Conec MTP brand Connectors provide quick and simple connection for 12 or 24 fibres in a single housing. The Elite® low loss Connector ensures the optical alignment through patented high precision pins and floating ferrule and conforms with IEC 61754-7 and TIA 604-5.

NB. Part numbers shown are for 10m length. Other lengths are available.

RapidNet MTP Back-Bone Cables OM3 Multimode 24 Core MTP

Features and Benefits

- High performance low loss Elite® Connectors from US Conec
- Compatible with all MTP RapidNet Cassettes
- Available in OM3, OM4 and OS1
- Can be used as back-bone fibre link or MTP Patch Lead
- Pre-tested with test results supplied

Product Description

The MTP Back-Bone cable is pre-terminated and pre-tested ensuring the highest performance. The MTP Connector is the low loss Elite® Connector from US Conec and is compatible with all RapidNet MTP Cassettes.

The MTP Back-Bone cable can be used for high density patching between two MTP ports.



MTP Back-Bone cable with low loss Elite® Connectors from US Conec

Technical Data Table

Article-No.	Type	Performance Category	Length (L)	Colour
860-00011	FLX24M3-MFMFXA-10.0M	OM3 Multimode	10.0 m	Aquamarine (AE)

All dimensions in mm. Subject to technical changes.

Technical Description

US Conec MTP brand Connectors provide quick and simple connection for 12 or 24 fibres in a single housing. The Elite® low loss Connector ensures the optical alignment through patented high precision pins and floating ferrule and conforms with IEC 61754-7 and TIA 604-5.

NB. Part numbers shown are for 10m length. Other lengths are available.



RapidNet MTP Back-Bone Cables
OS1 Multimode 24 Core MTP

Features and Benefits

- High performance connectors from US Conec
- Compatible with all MTP RapidNet Cassettes
- Available in OM3, OM4 and OS1
- Can be used as back-bone fibre link or MTP Patch Lead
- Pre-tested with test results supplied

Product Description

The MTP Back-Bone cable is pre-terminated and pre-tested ensuring the highest performance. The MTP connector from US Conec is compatible with all RapidNet MTP Cassettes.

The MTP Back-Bone cable can be used for high density patching between two MTP ports.



MTP Back-Bone cable with connectors from US Conec

Technical Data Table

Article-No.	Type	Performance Category	Length (L)	Colour
860-00014	FLS24S1-MFMFX-10.0M	OS1 Single Mode	10.0 m	Yellow (YE)

All dimensions in mm. Subject to technical changes.

Technical Description

US Conec MTP brand Connectors provide quick and simple connection for 12 or 24 fibres in a single housing. The patented floating ferrule design helps to ensure good optical alignment of all fibres and conforms with IEC 61754-7 and TIA 604-5.

NB. Part numbers shown are for 10m length. Other lengths are available.

RapidNet MTP Back-Bone Cables
OM4 Multimode 12 Core MTP

Features and Benefits

- High performance low loss Elite® Connectors from US Conec
- Compatible with all MTP RapidNet Cassettes
- Available in OM3, OM4 and OS1
- Can be used as back-bone fibre link or MTP Patch Lead
- Pre-tested with test results supplied

Product Description

The MTP Back-Bone cable is pre-terminated and pre-tested ensuring the highest performance. The MTP Connector is the low loss Elite® Connector from US Conec and is compatible with all RapidNet MTP Cassettes.

The MTP Back-Bone cable can be used for high density patching between two MTP ports.



MTP Back-Bone cable with low loss Elite® Connectors from US Conec

Technical Data Table

Article-No.	Type	Performance Category	Length (L)	Colour
860-00017	FLS12M4-MFMFXA-10.0M	OM4 Multimode	10.0 m	Aquamarine (AE)

All dimensions in mm. Subject to technical changes.

Technical Description

US Conec MTP brand Connectors provide quick and simple connection for 12 or 24 fibres in a single housing. The Elite® low loss Connector ensures the optical alignment through patented high precision pins and floating ferrule and conforms with IEC 61754-7 and TIA 604-5.

NB. Part numbers shown are for 10m length. Other lengths are available.



RapidNet MTP Back-Bone Cables OM3 Multimode 12 Core MTP

Features and Benefits

- High performance low loss Elite® Connectors from US Conec
- Compatible with all MTP RapidNet Cassettes
- Available in OM3, OM4 and OS1
- Can be used as back-bone fibre link or MTP Patch Lead
- Pre-tested with test results supplied

Product Description

The MTP Back-Bone cable is pre-terminated and pre-tested ensuring the highest performance. The MTP Connector is the low loss Elite® Connector from US Conec and is compatible with all RapidNet MTP Cassettes.

The MTP Back-Bone cable can be used for high density patching between two MTP ports.



MTP Back-Bone cable with low loss Elite® Connectors from US Conec

Technical Data Table

Article-No.	Type	Performance Category	Length (L)	Colour
860-00020	FLS12M3-MFMFXA-10.0M	OM3 Multimode	10.0 m	Aquamarine (AE)

All dimensions in mm. Subject to technical changes.

Technical Description

US Conec MTP brand Connectors provide quick and simple connection for 12 or 24 fibres in a single housing. The Elite® low loss Connector ensures the optical alignment through patented high precision pins and floating ferrule and conforms with IEC 61754-7 and TIA 604-5.

NB. Part numbers shown are for 10m length. Other lengths are available.

RapidNet MTP Back-Bone Cables OS1 Single Mode 12 Core MTP

Features and Benefits

- High performance low loss Elite® Connectors from US Conec
- Compatible with all MTP RapidNet Cassettes
- Available in OM3, OM4 and OS1
- Can be used as back-bone fibre link or MTP Patch Lead
- Pre-tested with test results supplied

Product Description

The MTP Back-Bone cable is pre-terminated and pre-tested ensuring the highest performance. The MTP Connector is the low loss Elite® Connector from US Conec and is compatible with all RapidNet MTP cassettes.

The MTP Back-Bone cable can be used for high density patching between two MTP ports.



MTP Back-Bone cable with low loss Elite® Connectors from US Conec

Technical Data Table

Article-No.	Type	Performance Category	Length (L)	Colour
860-00023	FLS12S1-MFMFXA-10.0M	OS1 Single Mode	10.0 m	Yellow (YE)

All dimensions in mm. Subject to technical changes.

Technical Description

US Conec MTP brand Connectors provide quick and simple connection for 12 or 24 fibres in a single housing. The Elite® low loss Connector ensures the optical alignment through patented high precision pins and floating ferrule and conforms with IEC 61754-7 and TIA 604-5.

NB. Part numbers shown are for 10m length. Other lengths are available.



Fibre Panels

LC Multimode Panel

Features and Benefits

- Sliding Panels for easy access when terminating
- On board Fibre Optic Management
- Multiple cable entry options and securing points
- Available in Duplex (48 fibre) and Quad (96 fibre)
- Also available in single mode
- Supplied with Rack Snap mounting fixings

Product Description

The 19" sliding drawer patch panel with 24 vertical slots for LC Adaptors (duplex or quad).

The panel is supplied pre-loaded with the required adaptors with any unused slots fitted with blanks, each fibre port is numbered separately to make identification easier.



Fibre panels from HellermannTyton can be fitted with LC Duplex, LC Quad, SC Simplex and SC Duplex adapters

Technical Data Table

Article-No.	Type	Performance Category	Height (H)	Width (W)	Depth (D)	Port count	Colour
855-00221	FBPDBKL-LCMMDX-24VF1	Multimode	44.0	483.0	200.0	48	Black (BK)
855-00266	FBPDBKL-LCMMQD-24VF1	Multimode	44.0	483.0	200.0	96	Black (BK)

All dimensions in mm. Subject to technical changes.

Technical Description

The rear of the drawer offers a number of cable options including 4x10mm and 2x20mm gland holes, and a removable section in the centre for specialist cables or patch leads. In addition, the base of the tray has cable securing points and cable management holes for

securing Fibre Optic Management (FOM). Adjustable mounting ears allow the panel to be positioned within the rack or frame.

Fibre Panels

LC Single Mode Panel

Features and Benefits

- Sliding Panels for easy access when terminating
- On board Fibre Optic Management
- Multiple cable entry options and securing points
- Available in Duplex (48 fibre) and Quad (96 fibre)
- Also available in multimode
- Supplied with Rack Snap mounting fixings

Product Description

The 19" sliding drawer patch panel with 24 vertical slots for LC Adaptors (duplex or quad).

The panel is supplied pre-loaded with the required adaptors with any unused slots fitted with blanks, each fibre port is numbered separately to make identification easier.



Fibre panels from HellermannTyton can be fitted with LC Duplex, LC Quad, SC Simplex and SC Duplex adapters

Technical Data Table

Article-No.	Type	Performance Category	Height (H)	Width (W)	Depth (D)	Port count	Colour
855-00222	FBPDBKL-LCSMDX-24VF1	Single Mode	44.0	483.0	200.0	48	Black (BK)
855-00268	FBPDBKL-LCSMQD-24VF1	Single Mode	44.0	483.0	200.0	96	Black (BK)

All dimensions in mm. Subject to technical changes.

Technical Description

The rear of the drawer offers a number of cable options including 4x10mm and 2x20mm gland holes, and a removable section in the centre for specialist cables or patch leads. In addition, the base of the tray has cable securing points and cable management holes for

securing Fibre Optic Management (FOM). Adjustable mounting ears allow the panel to be positioned within the rack or frame.



Fibre Panels

SC Multimode Panel

Features and Benefits

- Sliding Panels for easy access when terminating
- On board Fibre Optic Management
- Multiple cable entry options and securing points
- Available in duplex (48 fibre)
- Also available in multimode
- Supplied with Rack Snap mounting fixings

Product Description

The 19" sliding drawer patch panel with 24 vertical slots for SC Adaptors (simplex or duplex).

The panel is supplied pre-loaded with the required adaptors with any unused slots fitted with blanks, each fibre port is numbered separately to make identification easier.



Fibre panels from HellermannTyton can be fitted with LC Duplex, LC Quad, SC Simplex and SC Duplex adapters

Technical Data Table

Article-No.	Type	Performance Category	Height (H)	Width (W)	Depth (D)	Port count	Colour
855-00218	FBPDBKL-SCMMDX-24VF1	Multimode	44.0	483.0	200.0	48	Black (BK)

All dimensions in mm. Subject to technical changes.

Technical Description

The rear of the drawer offers a number of cable options including 4x10mm and 2x20mm gland holes, and a removable section in the centre for specialist cables or patch leads. In addition, the base of the tray has cable securing points and cable management holes for

securing Fibre Optic Management (FOM). Adjustable mounting ears allow the panel to be positioned within the rack or frame.

Fibre Panels

SC Single Mode Panel

Features and Benefits

- Sliding Panels for easy access when terminating
- On board Fibre Optic Management
- Multiple cable entry options and securing points
- Available in duplex (48 fibre)
- Also available in multimode
- Supplied with Rack Snap mounting fixings

Product Description

The 19" sliding drawer patch panel with 24 vertical slots for SC Adaptors (simplex or duplex).

The panel is supplied pre-loaded with the required adaptors with any unused slots fitted with blanks, each fibre port is numbered separately to make identification easier.



Fibre panels from HellermannTyton can be fitted with LC Duplex, LC Quad, SC Simplex and SC Duplex adapters

Technical Data Table

Article-No.	Type	Performance Category	Height (H)	Width (W)	Depth (D)	Port count	Colour
855-00219	FBPDBKL-SCSMDX-24VF1	Single Mode	44.0	483.0	200.0	48	Black (BK)

All dimensions in mm. Subject to technical changes.

Technical Description

The rear of the drawer offers a number of cable options including 4x10mm and 2x20mm gland holes, and a removable section in the centre for specialist cables or patch leads. In addition, the base of the tray has cable securing points and cable management holes for

securing Fibre Optic Management (FOM). Adjustable mounting ears allow the panel to be positioned within the rack or frame.

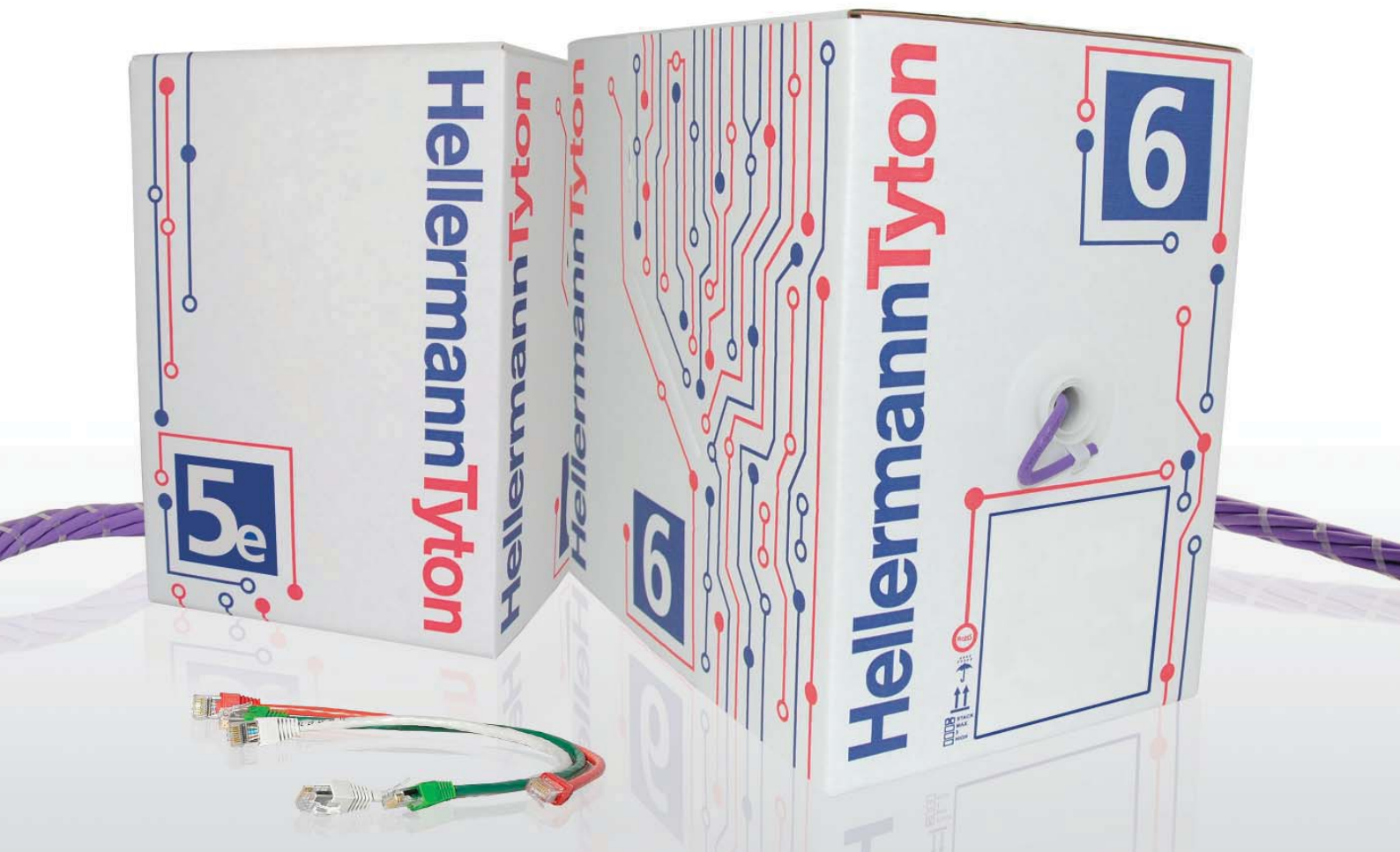

5 Cable

	Page
5.1 Bulk Copper Cable	
Category 6A LS0H Shielded U/FTP Cable	148
Category 6 LS0H Unshielded U/UTP Cable	148
Category 6 LS0H Shielded F/UTP Cable	149
Category 6 PVC Unshielded U/UTP Cable	149
Category 6 PVC Shielded F/UTP Cable	150
Category 5e LS0H Unshielded U/UTP Cable	150
Category 5e LS0H Shielded F/UTP Cable	151
Category 5e PVC Unshielded U/UTP Cable	151
Category 5e PVC Shielded F/UTP Cable	152
5.2 Patch Leads	
Category 6A Shielded LS0H	152
Category 6 LS0H – Blue	153
Category 6 LS0H – Green	153
Category 6 LS0H – Grey	154
Category 6 LS0H – Red	154
Category 6 LS0H – Yellow	155
Category 5e LS0H – Blue	155
Category 5e LS0H – Green	156
Category 5e LS0H – Grey	156
Category 5e LS0H – Red	157
Category 5e LS0H – Yellow	157
Category 5e PVC – Blue	158
Category 5e PVC – Green	158
Category 5e PVC – Grey	159
Category 5e PVC – Red	159
Category 5e PVC – Yellow	160

	Page
5.3 Bulk Fibre Cable	
Multimode OM4 Loose Tube	160
Multimode OM3 Loose Tube	161
Single Mode OS1 Loose Tube	161
Multimode OM4 Tight Buffered	162
Multimode OM3 Tight Buffered	162
Single Mode OS1 Tight Buffered	163
5.4 Fibre Patch Leads	
LC to LC Multimode	163
LC to LC Single Mode	164
SC to SC Multimode	164
SC to SC Single Mode	165



Bulk Copper Cable Category 6A LS0H Shielded Cable

Features and Benefits

- Exceeds Category 6A performance standards
- Uncompromised support for 10G
- Shielding eliminates alien crosstalk
- Supplied on 500m drums

Product Description

The Category 6A Cable is a U/FTP construction with individual pair screening eliminating the possibility of alien crosstalk.

The cable is marked at 1m intervals for accurate measuring.'

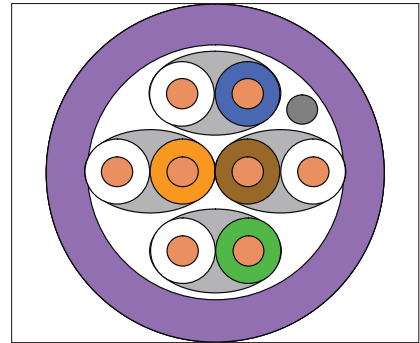

Category 6A U/FTP Cable

Technical Data Table

Article-No.	Type	Performance Category	Length (L)	Quantity per	Colour
851-05049	CA159	Category 6A (Class EA)	500.0 m	drum	Violet (VT)

Subject to technical changes.

Technical Description

The Category 6A Cable is constructed as a U/FTP Cable and meets or exceeds the relevant performance requirements of ISO/IEC 11801-2 and TIA/ANSI 568-C.2 EN50173, IEC 61156-5, EN 50288-10-1.

The LS0H sheath conforms with fire rating IEC 60332-1, 60754-2 and 61034.

The copper conductor is AWG 23 and the cable has a nominal overall diameter of 7.2mm

Bulk Copper Cable Category 6 LS0H Unshielded Cable

Features and Benefits

- Exceeds Category 6 standards
- LS0H sheath
- Supplied in sturdy boxes of 305m
- Metre marked for accurate measuring

Product Description

Category 6 U/UTP Cable from HellermannTyton is supplied in boxes of 305m and comes with a LS0H sheath.

The cable is marked at 1m intervals for accurate measuring.

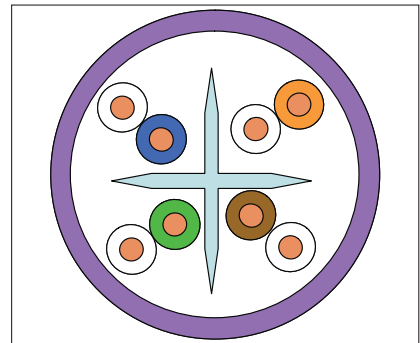

Unshielded Category 6 Cable

Technical Data Table

Article-No.	Type	Performance Category	Length (L)	Quantity per	Colour
851-05012	CA076	Category 6 (Class E)	305.0 m	box	Violet (VT)

Subject to technical changes.

Technical Description

The Category 6 Cable is constructed as a U/UTP Cable and meets or exceeds the relevant performance requirements of ISO/IEC 11801-2 and TIA/ANSI 568-C.2 EN50173, IEC 61156-5, EN 50288-10-1.

The LS0H sheath conforms with fire rating IEC 60332-1, 60754-2 and 61034.

The copper conductor is AWG 23 and the cable has a nominal overall diameter of 6.2mm



Bulk Copper Cable Category 6 LSOH Shielded Cable

Features and Benefits

- Exceeds Category 6 performance standards
- LSOH sheath
- Supplied on a 500m drum
- Foil shielding for increased performance
- Metre marked for accurate measuring

Product Description

Category 6 F/UTP Cable from HellermannTyton is supplied on a drum of 500m and comes with a LSOH sheath.

The cable is marked at 1m intervals for accurate measuring.

6

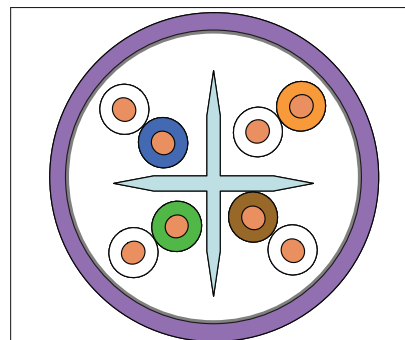

Category 6 LSOH Shielded Cable

Technical Data Table

Article-No.	Type	Performance Category	Length (L)	Quantity per	Colour
851-05036	CA120	Category 6 (Class E)	500.0 m	drum	Violet (VT)

Subject to technical changes.

Technical Description

The Category 6 Cable is constructed as a F/UTP Cable and meets or exceeds the relevant performance requirements of ISO/IEC 11801-2 and TIA/ANSI 568-C.2 EN50173, IEC 61156-5, EN 50288-10-1.

The LSOH sheath conforms with fire rating IEC 60332-1, 60754-2 and 61034.

The copper conductor is AWG 23 and the cable has a nominal overall diameter of 7.2mm

Bulk Copper Cable Category 6 PVC Unshielded Cable

Features and Benefits

- Exceeds Category 6 performance standards
- PVC sheath
- Supplied in a box of 305m
- Metre marked for accurate measuring

Product Description

Category 6 U/UTP PVC Cable from HellermannTyton is supplied in boxes of 305m and comes with PVC sheath.

The cable is marked at 1m intervals for accurate measuring.

6

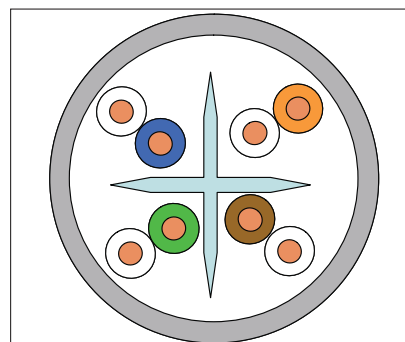

Category 6 PVC Unshielded Cable

Technical Data Table

Article-No.	Type	Performance Category	Length (L)	Quantity per	Colour
851-05016	CA085	Category 6 (Class E)	305.0 m	box	Grey (GY)

Subject to technical changes.

Technical Description

The Category 6 Cable is constructed as a U/UTP Cable and meets or exceeds the relevant performance requirements of ISO/IEC 11801-2 and TIA/ANSI 568-C.2 EN50173, IEC 61156-5, EN 50288-10-1.

The PVC sheath conforms with fire rating IEC 60332-1.

The copper conductor is AWG 23 and the cable has a nominal overall diameter of 6.2mm



Bulk Copper Cable Category 6 PVC Shielded Cable

Features and Benefits

- Exceeds Category 6 performance standards
- PVC sheath
- Supplied on a drum of 305m
- Foil shielding for increased performance
- Metre marked for accurate measuring

Product Description

Category 6 F/UTP PVC Cable from HellermannTyton is supplied on drums of 305m and comes with PVC sheath.

The cable is marked at 1m intervals for accurate measuring.

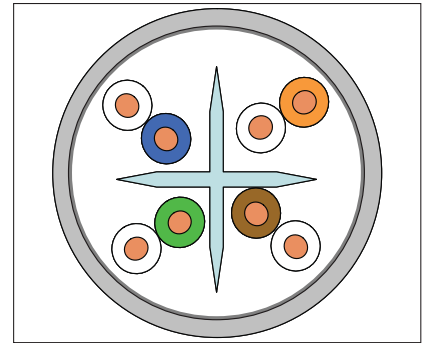
6

Category 6 PVC shielded Cable

Technical Data Table

Article-No.	Type	Performance Category	Length (L)	Quantity per	Colour
851-05020	CA113	Category 6 (Class E)	305.0 m	drum	Grey (GY)

Subject to technical changes.

Technical Description

The Category 6 Cable is constructed as a F/UTP Cable and meets or exceeds the relevant performance requirements of ISO/IEC 11801-2 and TIA/ANSI 568-C.2 EN50173, IEC 61156-5, EN 50288-10-1.

The PVC sheath conforms with fire rating IEC 60332-1.

The copper conductor is AWG 23 and the cable has a nominal overall diameter of 7.2mm

Bulk Copper Cable Category 5e LSOH Unshielded Cable

Features and Benefits

- Exceeds Category 5e standards
- LSOH sheath
- Supplied in sturdy boxes of 305m
- Metre marked for accurate measuring

Product Description

Category 5e U/UTP Cable from HellermannTyton is supplied in Reelex boxes of 305m and comes with a LSOH sheath.

Each box is supplied with Reelex for easy pulling during installation.

The cable is marked at 1m intervals for accurate measuring.

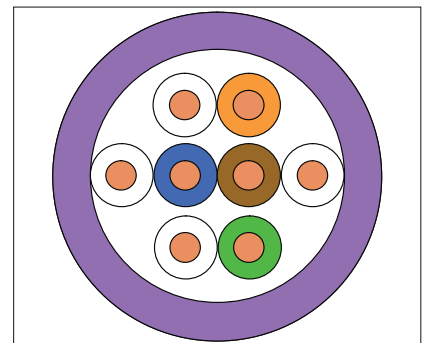
5e

Category 5e LSOH Unshielded Cable

Technical Data Table

Article-No.	Type	Performance Category	Length (L)	Quantity per	Colour
851-05011	CA075	Category 5E (Class D)	305.0 m	box	Violet (VT)

Subject to technical changes.

Technical Description

The Category 5e Cable is constructed as a U/UTP Cable and meets or exceeds the relevant performance requirements of ISO/IEC 11801-2 and TIA/ANSI 568-C.2 EN50173, IEC 61156-5, EN 50288-10-1.

The LSOH sheath conforms with fire rating IEC 60332-1, 60754-2 and 61034.

The copper conductor is AWG 24 and the cable has a nominal overall diameter of 5.1mm



Bulk Copper Cable

Category 5e LS0H Shielded Cable

Features and Benefits

- Exceeds Category 5e performance standards
- LS0H sheath
- Supplied in boxes of 305m
- Foil shielding for increased performance
- Metre marked for accurate measuring

Product Description

Category 5e F/UTP Cable from HellermannTyton is supplied in Reelex boxes of 305m and comes with a LS0H sheath.

Each box is supplied with Reelex for easy pulling during installation.

The cable is marked at 1m intervals for accurate measuring.

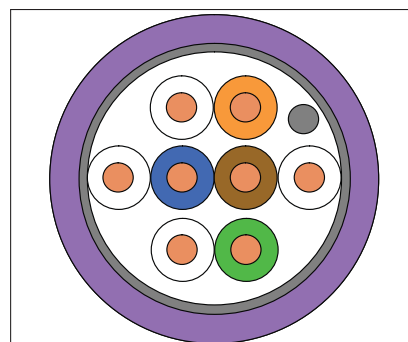

Category 5e LS0H shielded Cable

Technical Data Table

Article-No.	Type	Performance Category	Length (L)	Quantity per	Colour
851-05013	CA079	Category 5E (Class D)	305.0 m	box	Violet (VT)

Subject to technical changes.

Technical Description

The Category 5e Cable is constructed as a F/UTP Cable and meets or exceeds the relevant performance requirements of ISO/IEC 11801-2 and TIA/ANSI 568-C.2 EN50173, IEC 61156-5, EN 50288-10-1.

The LS0H sheath conforms with fire rating IEC 60332-1, 60754-2 and 61034.

The copper conductor is AWG 24 and the cable has a nominal overall diameter of 6.1mm

Bulk Copper Cable

Category 5e PVC Unshielded Cable

Features and Benefits

- Exceeds Category 5e performance standards
- PVC sheath
- Supplied in a box of 305m
- Metre marked for accurate measuring

Product Description

Category 5e U/UTP Cable from HellermannTyton is supplied in boxes of 305m and comes with PVC sheath.

Each box is supplied with Reelex for easy pulling during installation.

The cable is marked at 1m intervals for accurate measuring.

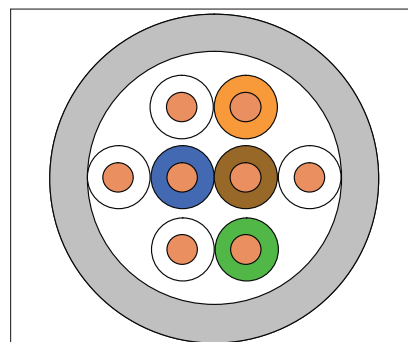

Category 5e PVC unshielded grey Cable

Technical Data Table

Article-No.	Type	Performance Category	Length (L)	Quantity per	Colour
851-05014	CA082	Category 5E (Class D)	305.0 m	box	Grey (GY)
851-05015	CA083	Category 5E (Class D)	305.0 m	box	Blue (BU)

Subject to technical changes.

Technical Description

The Category 5e Cable is constructed as a U/UTP Cable and meets or exceeds the relevant performance requirements of ISO/IEC 11801-2 and TIA/ANSI 568-C.2 EN50173, IEC 61156-5, EN 50288-10-1.

The PVC sheath conforms with fire rating IEC 60332-1.

The copper conductor is AWG 24 and the cable has a nominal overall diameter of 5.1mm



Bulk Copper Cable

Category 5e PVC Shielded Cable

Features and Benefits

- Exceeds Category 5e performance standards
- PVC sheath
- Supplied in a box of 305m
- Foil shielding for increased performance
- Metre marked for accurate measuring

Product Description

Category 5e F/UTP Cable from HellermannTyton is supplied in Reelex boxes of 305m and comes with PVC sheath.

Each box is supplied with Reelex for easy pulling during installation.

The cable is marked at 1m intervals for accurate measuring.

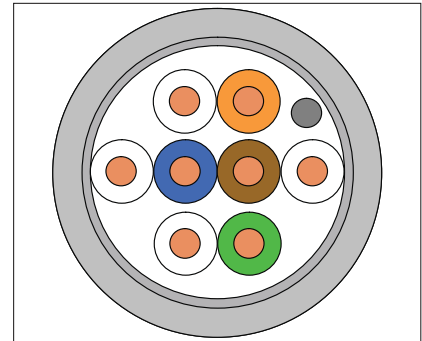

Category 5e PVC Shielded Cable

Technical Data Table

Article-No.	Type	Performance Category	Length (L)	Quantity per	Colour
851-05017	CA086	Category 5E (Class D)	305.0 m	box	Grey (GY)

Subject to technical changes.

Technical Description

The Category 5e Cable is constructed as a F/UTP Cable and meets or exceeds the relevant performance requirements of ISO/IEC 11801-2 and TIA/ANSI 568-C.2 EN50173, IEC 61156-5, EN 50288-10-1.

The PVC sheath conforms with fire rating IEC 60332-1.

The copper conductor is AWG 24 and the cable has a nominal overall diameter of 6.1mm

Patch Leads

Category 6A LS0H Shielded

Features and Benefits

- Uncompromised support for 10G
- Shielding eliminates alien crosstalk
- Exceeds Category 6A performance standards
- Supplied with test results
- LS0H Sheath

Product Description

Category 6A Shielded Copper Patch Leads are a critical component in ensuring the end to end performance of a 10G network. HellermannTyton's Patch Leads are manufactured and tested to the highest quality and exceed the component compliant requirements of the ISO/EIA 11801:2.2 and ANSI/TIA/EIA 568 - C.3 standards.



Category 6A LS0H Patch Leads

Technical Data Table

Article-No.	Type	Performance Category	Length (L)	Colour
851-30000	RJ45C6AGY-1.0M	Category 6A (Class EA)	1.0 m	Grey (GY)
851-30001	RJ45C6AGY-2.0M	Category 6A (Class EA)	2.0 m	Grey (GY)
851-30002	RJ45C6AGY-3.0M	Category 6A (Class EA)	3.0 m	Grey (GY)
851-30004	RJ45C6AGY-5.0M	Category 6A (Class EA)	5.0 m	Grey (GY)
851-30005	RJ45C6AGY-10.0M	Category 6A (Class EA)	10.0 m	Grey (GY)

Subject to technical changes.

Technical Description

The Category 6A Patch Leads incorporate a low profile shielded plug suitable for high density applications with an integral strain relief boot to minimise force on the terminations and to assist in

managing the bend radius of the cable. The patch lead cable is sheathed in LS0H material making them suitable for internal use.



Patch Leads

Category 6 LSOH - Blue

Features and Benefits

- Exceeds Category 6 performance standards
- Supplied with test results
- LSOH sheath
- Available in standard lengths of 1m, 2m, 3m, 5m and 10m

Product Description

Category 6 Copper Patch Leads are a critical component in ensuring the end to end performance of a network.

HellermannTyton's Patch Leads are manufactured and tested to the highest quality and exceed the component compliant requirements of the ISO/IEC 11801:2.2 and ANSI/TIA/EIA 568-C.2 standards.



Blue patch leads are available in standard lengths of 1m, 2m, 3m, 5m and 10m

6

Technical Data Table

Article-No.	Type	Performance Category	Length (L)	Colour
851-15235	RJ45NGB-1.0MBL	Category 6 (Class E)	1.0 m	Blue (BU)
851-15268	RJ45NGB-2.0MBL	Category 6 (Class E)	2.0 m	Blue (BU)
851-15283	RJ45NGB-3.0MBL	Category 6 (Class E)	3.0 m	Blue (BU)
851-15305	RJ45NGB-5.0M/BLUE	Category 6 (Class E)	5.0 m	Blue (BU)
851-15255	RJ45NGB-10.0MBL	Category 6 (Class E)	10.0 m	Blue (BU)

Subject to technical changes.

Technical Description

The Category 6 Patch Leads incorporate a low profile plug suitable for high density applications with an integral strain relief boot to minimise force on the terminations and to assist in managing the

bend radius of the cable. The patch lead cable is sheathed in LSOH material making them suitable for internal use.

Patch Leads

Category 6 LSOH - Green

Features and Benefits

- Exceeds Category 6 performance standards
- Supplied with test results
- LSOH sheath
- Available in standard lengths of 1m, 2m, 3m, 5m and 10m

Product Description

Category 6 Copper Patch Leads are a critical component in ensuring the end to end performance of a network.

HellermannTyton's Patch Leads are manufactured and tested to the highest quality and exceed the component compliant requirements of the ISO/IEC 11801:2.2 and ANSI/TIA/EIA 568-C.2 standards.



Green patch leads are available in standard lengths of 1m, 2m, 3m, 5m and 10m

6

Technical Data Table

Article-No.	Type	Performance Category	Length (L)	Colour
851-15236	RJ45NGB-1.0M/GREEN	Category 6 (Class E)	1.0 m	Green (GN)
851-15269	RJ45NGB-2.0MGN	Category 6 (Class E)	2.0 m	Green (GN)
851-15284	RJ45NGB-3.0M/GREEN	Category 6 (Class E)	3.0 m	Green (GN)
851-15306	RJ45NGB-5.0M/GREEN	Category 6 (Class E)	5.0 m	Green (GN)
851-15981	RJ45NGB-10.0M/GN	Category 6 (Class E)	10.0 m	Green (GN)

Subject to technical changes.

Technical Description

The Category 6 Patch Leads incorporate a low profile plug suitable for high density applications with an integral strain relief boot to minimise force on the terminations and to assist in managing the

bend radius of the cable. The patch lead cable is sheathed in LSOH material making them suitable for internal use.



Patch Leads

Category 6 LSOH - Grey

Features and Benefits

- Exceeds Category 6 performance standards
- Supplied with test results
- LSOH sheath
- Available in standard lengths of 1m, 2m, 3m, 5m and 10m

Product Description

Category 6 Copper Patch Leads are a critical component in ensuring the end to end performance of a network.

HellermannTyton's Patch Leads are manufactured and tested to the highest quality and exceed the component compliant requirements of the ISO/IEC 11801:2.2 and ANSI/TIA/EIA 568-C.2 standards.



Grey patch leads are available in standard lengths of 1m, 2m, 3m, 5m and 10m

6

Technical Data Table

Article-No.	Type	Performance Category	Length (L)	Colour
851-15823	RJ45NGB-1.0M/GY	Category 6 (Class E)	1.0 m	Grey (GY)
851-15270	RJ45NGB-2.0M/GY	Category 6 (Class E)	2.0 m	Grey (GY)
851-15285	RJ45NGB-3.0M/GY	Category 6 (Class E)	3.0 m	Grey (GY)
851-15224	RJ45NGB-5.0M/GY	Category 6 (Class E)	5.0 m	Grey (GY)
851-15983	RJ45NGB-10.0M/GY	Category 6 (Class E)	10.0 m	Grey (GY)

Subject to technical changes.

Technical Description

The Category 6 Patch Leads incorporate a low profile plug suitable for high density applications with an integral strain relief boot to minimise force on the terminations and to assist in managing the

bend radius of the cable. The patch lead cable is sheathed in LSOH material making them suitable for internal use.

Patch Leads

Category 6 LSOH - Red

Features and Benefits

- Exceeds Category 6 performance standards
- Supplied with test results
- LSOH sheath
- Available in standard lengths of 1m, 2m, 3m, 5m and 10m

Product Description

Category 6 Copper Patch Leads are a critical component in ensuring the end to end performance of a network.

HellermannTyton's Patch Leads are manufactured and tested to the highest quality and exceed the component compliant requirements of the ISO/IEC 11801:2.2 and ANSI/TIA/EIA 568-C.2 standards.



Red patch leads are available in standard lengths of 1m, 2m, 3m, 5m and 10m

6

Technical Data Table

Article-No.	Type	Performance Category	Length (L)	Colour
851-15241	RJ45NGB-1.0M/RD	Category 6 (Class E)	1.0 m	Red (RD)
851-15274	RJ45NGB-2.0M/RD	Category 6 (Class E)	2.0 m	Red (RD)
851-15289	RJ45NGB-3.0M/RD	Category 6 (Class E)	3.0 m	Red (RD)
851-15310	RJ45NGB-5.0M/RD	Category 6 (Class E)	5.0 m	Red (RD)
851-15257	RJ45NGB-10.0M/RD	Category 6 (Class E)	10.0 m	Red (RD)

Subject to technical changes.

Technical Description

The Category 6 Patch Leads incorporate a low profile plug suitable for high density applications with an integral strain relief boot to minimise force on the terminations and to assist in managing the

bend radius of the cable. The patch lead cable is sheathed in LSOH material making them suitable for internal use.



Patch Leads

Category 6 LSOH - Yellow

Features and Benefits

- Exceeds Category 6 performance standards
- Supplied with test results
- LSOH sheath
- Available in standard lengths of 1m, 2m, 3m, 5m and 10m

Product Description

Category 6 Copper Patch Leads are a critical component in ensuring the end to end performance of a network.

HellermannTyton's Patch Leads are manufactured and tested to the highest quality and exceed the component compliant requirements of the ISO/IEC 11801:2.2 and ANSI/TIA/EIA 568-C.2 standards.



Yellow patch leads are available in standard lengths of 1m, 2m, 3m, 5m and 10m

6

Technical Data Table

Article-No.	Type	Performance Category	Length (L)	Colour
851-15243	RJ45NGB-1.0M/YL	Category 6 (Class E)	1.0 m	Yellow (YE)
851-15276	RJ45NGB-2.0M/YL	Category 6 (Class E)	2.0 m	Yellow (YE)
851-15291	RJ45NGB-3.0M/YELLOW	Category 6 (Class E)	3.0 m	Yellow (YE)
851-15312	RJ45NGB-5.0M/YL	Category 6 (Class E)	5.0 m	Yellow (YE)
851-15404	RJ45NGB-10.0M/YL	Category 6 (Class E)	10.0 m	Yellow (YE)

Subject to technical changes.

Technical Description

The Category 6 Patch Leads incorporate a low profile plug suitable for high density applications with an integral strain relief boot to minimise force on the terminations and to assist in managing the

bend radius of the cable. The patch lead cable is sheathed in LSOH material making them suitable for internal use.

Patch Leads

Category 5e LSOH - Blue

Features and Benefits

- Exceeds Category 5e performance standards
- Supplied with test results
- LSOH sheath
- Available in standard lengths of 1m, 2m, 3m, 5m and 10m

Product Description

Category 5e Copper Patch Leads are a critical component in ensuring the end to end performance of a network.

HellermannTyton's Patch Leads are manufactured and tested to the highest quality and exceed the component compliant requirements of the ISO/IEC 11801:2.2 and ANSI/TIA/EIA 568-C.2 standards.



Blue patch leads are available in standard lengths of 1m, 2m, 3m, 5m and 10m

5e

Technical Data Table

Article-No.	Type	Performance Category	Length (L)	Colour
851-10813	RJ45C5E-1.0MLSBL	Category 5E (Class D)	1.0 m	Blue (BU)
851-10698	RJ45C5E-2.0M-LSOH/BL	Category 5E (Class D)	2.0 m	Blue (BU)
851-10699	RJ45C5E-3.0M-LSOH/BL	Category 5E (Class D)	3.0 m	Blue (BU)
851-10775	RJ45C5E-5.0MLS/BL	Category 5E (Class D)	5.0 m	Blue (BU)
851-10776	RJ45C5E-10.0MLSBL	Category 5E (Class D)	10.0 m	Blue (BU)

Subject to technical changes.

Technical Description

The Category 5e Patch Leads incorporate a low profile plug suitable for high density applications with an integral strain relief boot to minimise force on the terminations and to assist in managing the

bend radius of the cable. The patch lead cable is sheathed in LSOH material making them suitable for internal use.



Patch Leads

Category 5e LSOH - Green

Features and Benefits

- Exceeds Category 5e performance standards
- Supplied with test results
- LSOH sheath
- Available in standard lengths of 1m, 2m, 3m, 5m and 10m

Product Description

Category 5e Copper Patch Leads are a critical component in ensuring the end to end performance of a network.

HellermannTyton's Patch Leads are manufactured and tested to the highest quality and exceed the component compliant requirements of the ISO/IEC 11801:2.2 and ANSI/TIA/EIA 568-C.2 standards.



Green patch leads are available in standard lengths of 1m, 2m, 3m, 5m and 10m



Technical Data Table

Article-No.	Type	Performance Category	Length (L)	Colour
851-10749	RJ45C5E-1.0MLS/GN	Category 5E (Class D)	1.0 m	Green (GN)
851-10751	RJ45C5E-2.0MLS/GN	Category 5E (Class D)	2.0 m	Green (GN)
851-10778	RJ45C5E-3.0MLS/GN	Category 5E (Class D)	3.0 m	Green (GN)
851-10779	RJ45C5E-5.0MLS/GN	Category 5E (Class D)	5.0 m	Green (GN)
851-10780	RJ45C5E-10.0MLS/GN	Category 5E (Class D)	10.0 m	Green (GN)

Subject to technical changes.

Technical Description

The Category 5e Patch Leads incorporate a low profile plug suitable for high density applications with an integral strain relief boot to minimise force on the terminations and to assist in managing the

bend radius of the cable. The patch lead cable is sheathed in LSOH material making them suitable for internal use.

Patch Leads

Category 5e LSOH - Grey

Features and Benefits

- Exceeds Category 5e performance standards
- Supplied with test results
- LSOH sheath
- Available in standard lengths of 1m, 2m, 3m, 5m and 10m

Product Description

Category 5e Copper Patch Leads are a critical component in ensuring the end to end performance of a network.

HellermannTyton's Patch Leads are manufactured and tested to the highest quality and exceed the component compliant requirements of the ISO/IEC 11801:2.2 and ANSI/TIA/EIA 568-C.2 standards.



Grey patch leads are available in standard lengths of 1m, 2m, 3m, 5m and 10m



Technical Data Table

Article-No.	Type	Performance Category	Length (L)	Colour
851-10682	RJ45C5E-1.0M-LSOH/GY	Category 5E (Class D)	1.0 m	Grey (GY)
851-10685	RJ45C5E-2.0M-LSOH/GY	Category 5E (Class D)	2.0 m	Grey (GY)
851-10310	RJ45C5E-3.0M-LSOH/GY	Category 5E (Class D)	3.0 m	Grey (GY)
851-10611	RJ45C5E-5.0M-LSOH/GY	Category 5E (Class D)	5.0 m	Grey (GY)
851-10777	RJ45C5E-10.0MLS/GY	Category 5E (Class D)	10.0 m	Grey (GY)

Subject to technical changes.

Technical Description

The Category 5e Patch Leads incorporate a low profile plug suitable for high density applications with an integral strain relief boot to minimise force on the terminations and to assist in managing the

bend radius of the cable. The patch lead cable is sheathed in LSOH material making them suitable for internal use.



Patch Leads

Category 5e LS0H - Red

Features and Benefits

- Exceeds Category 5e performance standards
- Supplied with test results
- LS0H sheath
- Available in standard lengths of 1m, 2m, 3m, 5m and 10m

Product Description

Category 5e Copper Patch Leads are a critical component in ensuring the end to end performance of a network.

HellermannTyton's Patch Leads are manufactured and tested to the highest quality and exceed the component compliant requirements of the ISO/IEC 11801:2.2 and ANSI/TIA/EIA 568-C.2 standards.



Red patch leads are available in standard lengths of 1m, 2m, 3m, 5m and 10m



Technical Data Table

Article-No.	Type	Performance Category	Length (L)	Colour
851-10748	RJ45C5E-1.0MLS/RD	Category 5E (Class D)	1.0 m	Red (RD)
851-10700	RJ45C5E-2.0M-LS0H/RD	Category 5E (Class D)	2.0 m	Red (RD)
851-10311	RJ45C5E-3.0M-LS0H/RD	Category 5E (Class D)	3.0 m	Red (RD)
851-10773	RJ45C5E-5.0MLS/RD	Category 5E (Class D)	5.0 m	Red (RD)
851-10774	RJ45C5E-10.0MLS/RD	Category 5E (Class D)	10.0 m	Red (RD)

Subject to technical changes.

Technical Description

The Category 5e Patch Leads incorporate a low profile plug suitable for high density applications with an integral strain relief boot to minimise force on the terminations and to assist in managing the

bend radius of the cable. The patch lead cable is sheathed in LS0H material making them suitable for internal use.

Patch Leads

Category 5e LS0H - Yellow

Features and Benefits

- Exceeds Category 5e performance standards
- Supplied with test results
- LS0H sheath
- Available in standard lengths of 1m, 2m, 3m, 5m and 10m

Product Description

Category 5e Copper Patch Leads are a critical component in ensuring the end to end performance of a network.

HellermannTyton's Patch Leads are manufactured and tested to the highest quality and exceed the component compliant requirements of the ISO/IEC 11801:2.2 and ANSI/TIA/EIA 568-C.2 standards.



Yellow patch leads are available in standard lengths of 1m, 2m, 3m, 5m and 10m



Technical Data Table

Article-No.	Type	Performance Category	Length (L)	Colour
851-10781	RJ45C5E-1.0MLS/YL	Category 5E (Class D)	1.0 m	Yellow (YE)
851-10281	RJ45C5E-2.0M-LS0H/YL	Category 5E (Class D)	2.0 m	Yellow (YE)
851-10312	RJ45C5E-3.0M-LS0H/YL	Category 5E (Class D)	3.0 m	Yellow (YE)
851-10378	RJ45C5E-5.0M/LS0H/YL	Category 5E (Class D)	5.0 m	Yellow (YE)
851-10783	RJ45C5E-10.0MLS/YL	Category 5E (Class D)	10.0 m	Yellow (YE)

Subject to technical changes.

Technical Description

The Category 5e Patch Leads incorporate a low profile plug suitable for high density applications with an integral strain relief boot to minimise force on the terminations and to assist in managing the

bend radius of the cable. The patch lead cable is sheathed in LS0H material making them suitable for internal use.



Patch Leads

Category 5e PVC - Blue

Features and Benefits

- Exceeds Category 5e performance standards
- Supplied with test results
- Manufactured with PVC sheath
- Available in standard lengths of 1m, 2m, 3m, 5m and 10m

Product Description

Category 5e Copper Patch Leads are a critical component in ensuring the end to end performance of a network.

HellermannTyton's Patch Leads are manufactured and tested to the highest quality and exceed the component compliant requirements of the ISO/IEC 11801:2.2 and ANSI/TIA/EIA 568-C.2 standards.



Blue patch leads are available in standard lengths of 1m, 2m, 3m, 5m and 10m



Technical Data Table

Article-No.	Type	Performance Category	Length (L)	Colour
851-10223	RJ45C5E-1.0M/BL	Category 5E (Class D)	1.0 m	Blue (BU)
851-10263	RJ45C5E-2.0M/BL	Category 5E (Class D)	2.0 m	Blue (BU)
851-10301	RJ45C5E-3.0M/BL	Category 5E (Class D)	3.0 m	Blue (BU)
851-10334	RJ45C5E-5.0M/BL	Category 5E (Class D)	5.0 m	Blue (BU)
851-10244	RJ45C5E-10.0M/BL	Category 5E (Class D)	10.0 m	Blue (BU)

Subject to technical changes.

Technical Description

The Category 5e Patch Leads incorporate a low profile plug suitable for high density applications with an integral strain relief boot to minimise force on the terminations and to assist in managing the bend radius of the cable.

The patch lead cable is sheathed in PVC material.

Patch Leads

Category 5e PVC - Green

Features and Benefits

- Exceeds Category 5e performance standards
- Supplied with test results
- Manufactured with PVC sheath
- Available in standard lengths of 1m, 2m, 3m, 5m and 10m

Product Description

Category 5e Copper Patch Leads are a critical component in ensuring the end to end performance of a network.

HellermannTyton's Patch Leads are manufactured and tested to the highest quality and exceed the component compliant requirements of the ISO/IEC 11801:2.2 and ANSI/TIA/EIA 568-C.2 standards.



Green patch leads are available in standard lengths of 1m, 2m, 3m, 5m and 10m



Technical Data Table

Article-No.	Type	Performance Category	Length (L)	Colour
851-10225	RJ45C5E-1.0M/GN	Category 5E (Class D)	1.0 m	Green (GN)
851-10268	RJ45C5E-2.0M/GN	Category 5E (Class D)	2.0 m	Green (GN)
851-10303	RJ45C5E-3.0M/GN	Category 5E (Class D)	3.0 m	Green (GN)
851-10337	RJ45C5E-5.0M/GN	Category 5E (Class D)	5.0 m	Green (GN)
851-10245	RJ45C5E-10.0M/GN	Category 5E (Class D)	10.0 m	Green (GN)

Subject to technical changes.

Technical Description

The Category 5e Patch Leads incorporate a low profile plug suitable for high density applications with an integral strain relief boot to minimise force on the terminations and to assist in managing the bend radius of the cable.

The patch lead cable is sheathed in PVC material.



Patch Leads

Category 5e PVC - Grey

Features and Benefits

- Exceeds Category 5e performance standards
- Supplied with test results
- Manufactured with PVC sheath
- Available in standard lengths of 1m, 2m, 3m, 5m and 10m

Product Description

Category 5e Copper Patch Leads are a critical component in ensuring the end to end performance of a network.

HellermannTyton's Patch Leads are manufactured and tested to the highest quality and exceed the component compliant requirements of the ISO/IEC 11801:2.2 and ANSI/TIA/EIA 568-C.2 standards.



Grey patch leads are available in standard lengths of 1m, 2m, 3m, 5m and 10m



Technical Data Table

Article-No.	Type	Performance Category	Length (L)	Colour
851-10226	RJ45C5E-1.0M/GY	Category 5E (Class D)	1.0 m	Grey (GY)
851-10270	RJ45C5E-2.0M/GY	Category 5E (Class D)	2.0 m	Grey (GY)
851-10304	RJ45C5E-3.0M/GY	Category 5E (Class D)	3.0 m	Grey (GY)
851-10338	RJ45C5E-5.0M/GY	Category 5E (Class D)	5.0 m	Grey (GY)
851-10246	RJ45C5E-10.0M/GY	Category 5E (Class D)	10.0 m	Grey (GY)

Subject to technical changes.

Technical Description

The Category 5e Patch Leads incorporate a low profile plug suitable for high density applications with an integral strain relief boot to minimise force on the terminations and to assist in managing the bend radius of the cable.

The patch lead cable is sheathed in PVC material.

Patch Leads

Category 5e PVC - Red

Features and Benefits

- Exceeds Category 5e performance standards
- Supplied with test results
- Manufactured with PVC sheath
- Available in standard lengths of 1m, 2m, 3m, 5m and 10m

Product Description

Category 5e Copper Patch Leads are a critical component in ensuring the end to end performance of a network.

HellermannTyton's Patch Leads are manufactured and tested to the highest quality and exceed the component compliant requirements of the ISO/IEC 11801:2.2 and ANSI/TIA/EIA 568-C.2 standards.



Red patch leads are available in standard lengths of 1m, 2m, 3m, 5m and 10m



Technical Data Table

Article-No.	Type	Performance Category	Length (L)	Colour
851-10228	RJ45C5E-1.0M/RD	Category 5E (Class D)	1.0 m	Red (RD)
851-10272	RJ45C5E-2.0M/RD	Category 5E (Class D)	2.0 m	Red (RD)
851-10306	RJ45C5E-3.0M/RD	Category 5E (Class D)	3.0 m	Red (RD)
851-10340	RJ45C5E-5.0M/RD	Category 5E (Class D)	5.0 m	Red (RD)
851-10247	RJ45C5E-10.0M/RD	Category 5E (Class D)	10.0 m	Red (RD)

Subject to technical changes.

Technical Description

The Category 5e Patch Leads incorporate a low profile plug suitable for high density applications with an integral strain relief boot to minimise force on the terminations and to assist in managing the bend radius of the cable.

The patch lead cable is sheathed in PVC material.



Patch Leads

Category 5e PVC - Yellow

Features and Benefits

- Exceeds Category 5e performance standards
- Supplied with test results
- Manufactured with PVC sheath
- Available in standard lengths of 1m, 2m, 3m, 5m and 10m

Product Description

Category 5e Copper Patch Leads are a critical component in ensuring the end to end performance of a network.

HellermannTyton's Patch Leads are manufactured and tested to the highest quality and exceed the component compliant requirements of the ISO/IEC 11801:2.2 and ANSI/TIA/EIA 568-C.2 standards.



Yellow patch leads are available in standard lengths of 1m, 2m, 3m, 5m and 10m



Technical Data Table

Article-No.	Type	Performance Category	Length (L)	Colour
851-10232	RJ45C5E-1.0M/YL	Category 5E (Class D)	1.0 m	Yellow (YE)
851-10279	RJ45C5E-2.0M/YL	Category 5E (Class D)	2.0 m	Yellow (YE)
851-10309	RJ45C5E-3.0M/YL	Category 5E (Class D)	3.0 m	Yellow (YE)
851-10343	RJ45C5E-5.0M/YL	Category 5E (Class D)	5.0 m	Yellow (YE)
851-10248	RJ45C5E-10.0M/YL	Category 5E (Class D)	10.0 m	Yellow (YE)

Subject to technical changes.

Technical Description

The Category 5e Patch Leads incorporate a low profile plug suitable for high density applications with an integral strain relief boot to minimise force on the terminations and to assist in managing the bend radius of the cable.

The patch lead cable is sheathed in PVC material.

Bulk Fibre Cable

Multimode OM4 Loose Tube

Features and Benefits

- Up to 24 fibres as standard
- Made with LSOH sheath
- Level 1 Rodent Protection
- Withstands damp environments
- Sold per metre
- Lightweight and compact cable ideal for building backbone applications

Product Description

All cables are designed to be easy to terminate, strong and capable of withstanding the strains of installation.

Using LSOH sheaths allows for cables to be used in both internal dry installation but still withstand the rigors of damp environments.

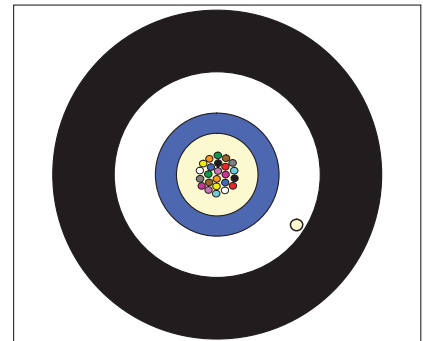

HellermannTyton's Loose Tube Fibre is available in OM4, OM3, OS1 and OS2

Technical Data Table

Article-No.	Type	Performance Category	Colour
855-40111	HT-OM4-12-LT	OM4 Multimode	Black (BK)
855-40112	HT-OM4-24-LT	OM4 Multimode	Black (BK)

All dimensions in mm. Subject to technical changes.

Technical Description

Using non-flammable gel moisture barrier and the LSOH sheath allows the loose tube cable to run all the way to the distribution point. This can eliminate the need for a splice point as the cable enters a building.

The fibre cable used is a 50/125µm OM4 multimode loose tube cable. The colour code of fibre conforms to TIA 568-C3.

Standard products listed, other core counts and cable constructions available on request.



Bulk Fibre Cable
Multimode OM3 Loose Tube

Features and Benefits

- Up to 24 fibres as standard
- Made with LSOH sheath
- Level 1 Rodent Protection
- Withstands damp environments
- Sold per metre
- Lightweight and compact cable ideal for building backbone applications

Product Description

All cables are designed to be easy to terminate, strong and capable of withstanding the strains of installation.

Using LSOH sheaths allows for cables to be used in both internal dry installation but still withstand the rigors of damp environments.

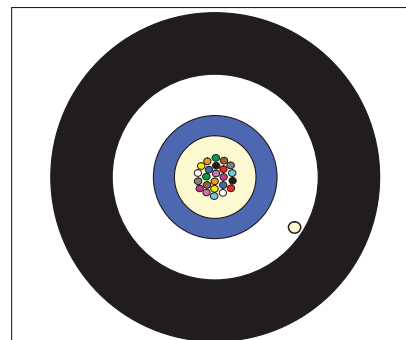

HellermannTyton's Loose Tube Fibre is available in OM4, OM3, OS1 and OS2

Technical Data Table

Article-No.	Type	Performance Category	Colour
855-40069	HT-OM3-4-LT	OM3 Multimode	Black (BK)
855-40070	HT-OM3-8-LT	OM3 Multimode	Black (BK)
855-40071	HT-OM3-12-LT	OM3 Multimode	Black (BK)
855-40073	HT-OM3-24-LT	OM3 Multimode	Black (BK)

All dimensions in mm. Subject to technical changes.

Technical Description

Using non-flammable gel moisture barrier and the LSOH sheath allows the loose tube cable to run all the way to the distribution point. This can eliminate the need for a splice point as the cable enters a building.

The fibre cable used is a 50/125µm OM3 multimode loose tube cable. The colour code of fibre conforms to TIA 568-C3.

Standard products listed, other core counts and cable constructions available on request.

Bulk Fibre Cable
Single Mode OS1 Loose Tube

Features and Benefits

- Up to 24 fibres as standard
- Made with LSOH sheath
- Level 1 Rodent Protection
- Withstands damp environments
- Sold per metre
- Lightweight and compact cable ideal for building backbone applications

Product Description

All cables are designed to be easy to terminate, strong and capable of withstanding the strains of installation.

Using LSOH sheaths allows for cables to be used in both internal dry installation but still withstand the rigors of damp environments.

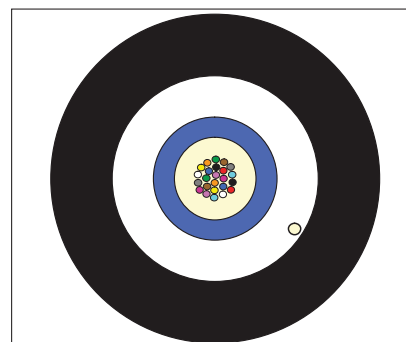

HellermannTyton's Loose Tube Fibre is available in OM4, OM3, OS1 and OS2

Technical Data Table

Article-No.	Type	Performance Category	Colour
855-40074	HT-OS1-4-LT	OS1 Single Mode	Black (BK)
855-40075	HT-OS1-8-LT	OS1 Single Mode	Black (BK)
855-40076	HT-OS1-12-LT	OS1 Single Mode	Black (BK)
855-40078	HT-OS1-24-LT	OS1 Single Mode	Black (BK)

All dimensions in mm. Subject to technical changes.

Technical Description

Using non-flammable gel moisture barrier and the LSOH sheath allows the loose tube cable to run all the way to the distribution point. This can eliminate the need for a splice point as the cable enters a building.

The fibre cable used is a 9/125µm OS1 single mode loose tube cable. The colour code of fibre conforms to TIA 568-C3.

Standard products listed, other core counts and cable constructions available on request.



Bulk Fibre Cable

Multimode OM4 Tight Buffered

Features and Benefits

- Up to 24 fibres as standard
- Made with LSOH sheath
- Level 1 Rodent Protection
- Withstands damp environments
- Sold in lengths per metre
- Lightweight and compact cable ideal for building backbone applications

Product Description

All cables are designed to be easy to terminate, strong and capable of withstanding the strains of installation.



HellermannTyton's Tight Buffered Fibre Cable is available in OM4, OM3, OS1 and OS2

Technical Data Table

Article-No.	Type	Performance Category	Colour
855-40113	HT-OM4-12-TB	OM4 Multimode	Black (BK)
855-40114	HT-OM4-24-TB	OM4 Multimode	Black (BK)

All dimensions in mm. Subject to technical changes.

Technical Description

The fibre cable used is a 50/125µm OM4 multimode tight buffered cable. The colour code of fibre conforms to TIA 568-C3.

Standard products listed, other core counts and cable constructions available on request.

Bulk Fibre Cable

Multimode OM3 Tight Buffered

Features and Benefits

- Up to 24 fibres as standard
- Made with LSOH sheath
- Level 1 Rodent Protection
- Withstands damp environments
- Sold in lengths per metre
- Lightweight and compact cable ideal for building backbone applications

Product Description

All cables are designed to be easy to terminate, strong and capable of withstanding the strains of installation.



HellermannTyton's Tight Buffered Fibre Cable is available in OM4, OM3, OS1 and OS2

Technical Data Table

Article-No.	Type	Performance Category	Colour
855-40089	HT-OM3-4-TB	OM3 Multimode	Black (BK)
855-40090	HT-OM3-8-TB	OM3 Multimode	Black (BK)
855-40091	HT-OM3-12-TB	OM3 Multimode	Black (BK)
855-40093	HT-OM3-24-TB	OM3 Multimode	Black (BK)

All dimensions in mm. Subject to technical changes.

Technical Description

The fibre cable used is a 50/125µm OM3 multimode tight buffered cable. The colour code of fibre conforms to TIA 568-C3.

Standard products listed, other core counts and cable constructions available on request.



Bulk Fibre Cable
Single Mode OS1 Tight Buffered

Features and Benefits

- Up to 24 fibres as standard
- Made with LSOH sheath
- Level 1 Rodent Protection
- Withstands damp or wet environments
- Sold in lengths per metre
- Lightweight and compact cable ideal for building backbone applications

Product Description

All cables are designed to be easy to terminate, strong and capable of withstanding the strains of installation.



HellermannTyton's Tight Buffered Fibre Cable is available in OM4, OM3, OS1 and OS2

Technical Data Table

Article-No.	Type	Performance Category	Colour
855-40094	HT-OS1-4-TB	OS1 Single Mode	Black (BK)
855-40095	HT-OS1-8-TB	OS1 Single Mode	Black (BK)
855-40096	HT-OS1-12-TB	OS1 Single Mode	Black (BK)
855-40098	HT-OS1-24-TB	OS1 Single Mode	Black (BK)

All dimensions in mm. Subject to technical changes.

Technical Description

The fibre cable used is a 9/125µm OS1 single mode tight buffered cable. The colour code of fibre conforms to TIA 568-C3.

Standard products listed, other core counts and cable constructions available on request.

Fibre Patch Leads
LC to LC Multimode

Features and Benefits

- Simplex and duplex options available
- Supplied with individual test results
- 3.0mm buffered fibre optic cable
- Available in 1,2,3,5 and 10 metre lengths as standard
- Patch leads are packaged individually in bags with test results

Product Description

Optical fibre patch leads are a defining factor in ensuring your network performs to the highest level.

All HellermannTyton Duplex Patch Leads are supplied as a cross over configuration as standard. Straight through patch leads are available on request. Cables are sheathed with LSOH material making them suitable for internal use.



Multimode LC to LC Patch Leads available in OM3 and OM4

Technical Data Table

Article-No.	Type	Performance Category	Length (L)	Colour
855-30920	FLCXXM4-LCLCDA-01.0M	OM4 Multimode	1.0 m	Aquamarine (AE)
855-30921	FLCXXM4-LCLCDA-02.0M	OM4 Multimode	2.0 m	Aquamarine (AE)
855-30922	FLCXXM4-LCLCDA-03.0M	OM4 Multimode	3.0 m	Aquamarine (AE)
855-30923	FLCXXM4-LCLCDA-05.0M	OM4 Multimode	5.0 m	Aquamarine (AE)
855-30924	FLCXXM4-LCLCDA-10.0M	OM4 Multimode	10.0 m	Aquamarine (AE)
855-30425	FLCXXM3-LCLCDA-01.0M	OM3 Multimode	1.0 m	Aquamarine (AE)
855-30426	FLCXXM3-LCLCDA-02.0M	OM3 Multimode	2.0 m	Aquamarine (AE)
855-30427	FLCXXM3-LCLCDA-03.0M	OM3 Multimode	3.0 m	Aquamarine (AE)
855-30429	FLCXXM3-LCLCDA-05.0M	OM3 Multimode	5.0 m	Aquamarine (AE)
855-30447	FLCXXM3-LCLCDA-10.0M	OM3 Multimode	10.0 m	Aquamarine (AE)

All dimensions in mm. Subject to technical changes.

Technical Description

- 3.0mm buffered fibre optic cable
- Cross over configuration as standard
- LSOH sheath
- Meets performance standards ISO/IEC 11801 and TIA/ANSI 568

Standard products listed. Other lengths and connector options available on request.



Fibre Patch Leads

LC to LC Single Mode

Features and Benefits

- Simplex and duplex options available
- Supplied with individual test results
- 3.0mm buffered fibre optic cable
- Available in 1,2,3,5 and 10 metre lengths as standard

Product Description

Optical fibre patch leads are a defining factor in ensuring your network performs to the highest level.

All HellermannTyton Duplex Patch Leads are supplied as a cross over configuration as standard. Straight through patch leads are available on request.

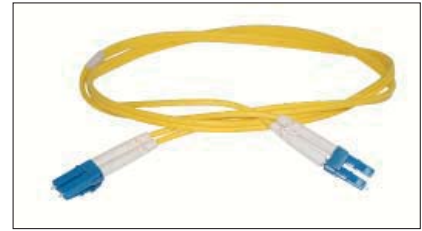

Single Mode Fibre LC Patch Leads

Technical Data Table

Article-No.	Type	Performance Category	Length (L)	Colour
855-30156	FLCXXS1-LCLCDY-01.0M	OS1 Single Mode	1.0 m	Yellow (YE)
855-30015	FLCXXS1-LCLCDY-02.0M	OS1 Single Mode	2.0 m	Yellow (YE)
855-30272	FLCXXS1-LCLCDY-03.0M	OS1 Single Mode	3.0 m	Yellow (YE)
855-30157	FLCXXS1-LCLCDY-05.0M	OS1 Single Mode	5.0 m	Yellow (YE)
855-30450	FLCXXS1-LCLCDY-10.0M	OS1 Single Mode	10.0 m	Yellow (YE)
855-30909	FLCXXS2-LCLCDY-01.0M	OS2 Single Mode	1.0 m	Yellow (YE)
855-30910	FLCXXS2-LCLCDY-02.0M	OS2 Single Mode	2.0 m	Yellow (YE)
855-30911	FLCXXS2-LCLCDY-03.0M	OS2 Single Mode	3.0 m	Yellow (YE)
855-30912	FLCXXS2-LCLCDY-05.0M	OS2 Single Mode	5.0 m	Yellow (YE)
855-30913	FLCXXS2-LCLCDY-10.0M	OS2 Single Mode	10.0 m	Yellow (YE)

All dimensions in mm. Subject to technical changes.

Technical Description

- 3.0mm buffered fibre optic cable
- Cross over configuration as standard
- LSOH sheath
- Meets performance standards ISO/IEC 11801 and TIA/ANSI 568

Standard products listed. Other lengths and connector options available on request.

Fibre Patch Leads

SC to SC Multimode

Features and Benefits

- Simplex and duplex options available
- Supplied with individual test results
- 3.0mm buffered fibre optic cable
- Available in 1,2,3,5 and 10 metre lengths as standard

Product Description

Optical fibre patch leads are a defining factor in ensuring your network performs to the highest level.

All HellermannTyton Duplex Patch Leads are supplied as a cross over configuration as standard. Straight through patch leads are available on request.



Multimode SC Fibre Patch Leads

Technical Data Table

Article-No.	Type	Performance Category	Length (L)	Colour
855-30925	FLCXXM4-SCSCDA-01.0M	OM4 Multimode	1.0 m	Aquamarine (AE)
855-30926	FLCXXM4-SCSCDA-02.0M	OM4 Multimode	2.0 m	Aquamarine (AE)
855-30927	FLCXXM4-SCSCDA-03.0M	OM4 Multimode	3.0 m	Aquamarine (AE)
855-30928	FLCXXM4-SCSCDA-05.0M	OM4 Multimode	5.0 m	Aquamarine (AE)
855-30929	FLCXXM4-SCSCDA-10.0M	OM4 Multimode	10.0 m	Aquamarine (AE)
855-30148	FLCXXM3-SCSCDA-01.0M	OM3 Multimode	1.0 m	Aquamarine (AE)
855-30309	FLCXXM3-SCSCDA-02.0M	OM3 Multimode	2.0 m	Aquamarine (AE)
855-30206	FLCXXM3-SCSCDA-03.0M	OM3 Multimode	3.0 m	Aquamarine (AE)
855-30448	FLCXXM3-SCSCDA-05.0M	OM3 Multimode	5.0 m	Aquamarine (AE)
855-30449	FLCXXM3-SCSCDA-10.0M	OM3 Multimode	10.0 m	Aquamarine (AE)

All dimensions in mm. Subject to technical changes.

Technical Description

- 3.0mm buffered fibre optic cable
- Cross over configuration as standard
- LSOH sheath
- Meets performance standards ISO/IEC 11801 and TIA/ANSI 568

Standard products listed. Other lengths and connector options available on request.



Fibre Patch Leads

SC to SC Single Mode

Features and Benefits

- Simplex and duplex options available
- Supplied with individual test results
- 3.0mm buffered fibre optic cable
- Available in 1,2,3,5 and 10 metre lengths as standard
- Patch leads are packaged individually in bags with test results

Product Description

Optical fibre patch leads are a defining factor in ensuring your network performs to the highest level.

All HellermannTyton Duplex Patch Leads are supplied as a cross over configuration as standard. Straight through patch leads are available on request. Cables are sheathed with LS0H material making them suitable for internal use.



Single Mode SC Fibre Patch Leads from HellermannTyton are supplied with test results

Technical Data Table

Article-No.	Type	Performance Category	Length (L)	Colour
855-30093	FLCXXS1-SCSCDY-01.0M	OS1 Single Mode	1.0 m	Yellow (YE)
855-30094	FLCXXS1-SCSCDY-02.0M	OS1 Single Mode	2.0 m	Yellow (YE)
855-30095	FLCXXS1-SCSCDY-03.0M	OS1 Single Mode	3.0 m	Yellow (YE)
855-30096	FLCXXS1-SCSCDY-05.0M	OS1 Single Mode	5.0 m	Yellow (YE)
855-30451	FLCXXS1-SCSCDY-10.0M	OS1 Single Mode	10.0 m	Yellow (YE)
855-30914	FLCXXS2-SCSCDY-01.0M	OS2 Single Mode	1.0 m	Yellow (YE)
855-30915	FLCXXS2-SCSCDY-02.0M	OS2 Single Mode	2.0 m	Yellow (YE)
855-30916	FLCXXS2-SCSCDY-03.0M	OS2 Single Mode	3.0 m	Yellow (YE)
855-30917	FLCXXS2-SCSCDY-05.0M	OS2 Single Mode	5.0 m	Yellow (YE)
855-30918	FLCXXS2-SCSCDY-10.0M	OS2 Single Mode	10.0 m	Yellow (YE)

All dimensions in mm. Subject to technical changes.

Technical Description

- 3.0mm buffered fibre optic cable
- Cross over configuration as standard
- LS0H sheath
- Meets performance standards ISO/IEC 11801 and TIA/ANSI 568

Standard products listed. Other lengths and connector options available on request.



HellermannTyton's extensive product range provides full end to end solutions for cabling projects of any size to all types of business

the sky's the limit

AlphaSnap

RapidNet

Deca¹⁰

EcoBand

Global

GigaBand

FibreBand

iD

iDActive

MegaBand

Better Technology through Innovation

www.htdata.co.uk

HellermannTyton



6 Accessories

	Page
6.1 Plastic Mounting Hardware	
Alpha Snap Double Gang Bevelled Faceplate	168
Alpha Snap Single Gang Bevelled Faceplate	168
Alpha Snap Double Gang Flat Faceplate	169
Alpha Snap Single Gang Flat Faceplate	169
Easy Clip Double Gang Faceplate	170
Easy Clip Single Gang Faceplate	170
MegaBand Double Gang Faceplate	171
MegaBand Single Gang Faceplate	171
Alpha Snap Half Blanks	172
Alpha Snap Quarter Blanks	172
Easy Clip Half Blanks	173
Easy Clip Quarter Blanks	173
MegaBand Half Blanks	174
MegaBand Quarter Blanks	174
6C Half Blanks	175
6C Adapters	175
GigaBand Empty Single Category 6 Modules	176
Alpha Snap Empty Single Category 5e Modules	176
Alpha Snap Angled Module	177
Easy Clip Angled Module	177
6C Angled Module	178
Alpha Snap Keystone Adapter	178
27mm Single Back Box	179
37mm Double Back Box	179
37mm Single Back Box	180

	Page
6.2 Cable Management	
Out Of Rack - 1U Space/2U RapidNet	180
Out Of Rack - 3U RapidNet	181
Out Of Rack - 3U Space	181
Front Cable Management	182
Rear Cable Management	182
1U Brush Strip Panel	183
Triple Rack Snaps	183
Single Rack Snaps	184
3U Hinged Wall Bracket	184
2U Hinged Wall Bracket	185
6.3 Accessories	
3 Port LAN Lock Unit	185
6 Port LAN Lock Unit	186
Sub Floor Box	186
Coolport Blue - Data and Voice Ports	187
Coolport Purple - 2 Data Ports	187
Coolport Red - Data and Voice Ports	188
Coolport Yellow - Voice Ports	188
Category 6A Termination Tool	189
Keystone Jack Palm Tool	189
RJ45 Dust Cover	190
MTP Fibre Cleaner	190
Fibre Connector Cleaning Pen	191



Plastic Mounting Hardware Alpha Snap Double Gang Bevelled Faceplate

Features and Benefits

- Strong, durable ABS plastic
- Accepts up to 4 Alpha Snap Outlets in a double gang
- Offers extra 10mm depth to the back box
- Supplied with fixing screws
- Can be individually screen printed with custom logo

Product Description

The bevelled double faceplate accepts 4 single Alpha Snap modules or 2 triple Alpha Snap modules.

The Alpha Snap Faceplate is made from white ABS plastic which is fire retardant and completes any installation with a professional look.



The Double Gang Faceplates accepts 4 single modules or 2 triple modules, to offer 4 or 6 ports

Technical Data Table

Article-No.	Type	Height (H)	Width (W)	Depth (D)	Quantity	Colour
854-35101	ASFP02/WH	87.0	148.0	15.0	15	White (WH)

All dimensions in mm. Subject to technical changes.

Plastic Mounting Hardware Alpha Snap Single Gang Bevelled Faceplate

Features and Benefits

- Strong, durable ABS plastic
- Accepts up to 2 Alpha Snap Outlets in a single gang
- Offers extra 10mm depth to the back box
- Supplied with fixing screws
- Can be individually screen printed with custom logo

Product Description

The bevelled single faceplate accepts 2 single Alpha Snap modules or 1 triple Alpha Snap module.

The Alpha Snap Faceplate is made from white ABS plastic which is fire retardant and completes any installation with a professional look.



The Single Gang Faceplates accepts 2 single modules or 1 triple module, to offer 2 or 3 RJ45 ports

Technical Data Table

Article-No.	Type	Height (H)	Width (W)	Depth (D)	Quantity	Colour
854-35202	ASFP01/WH	87.0	87.0	15.0	20	White (WH)

All dimensions in mm. Subject to technical changes.



Plastic Mounting Hardware

Alpha Snap Double Gang Flat Faceplate

Features and Benefits

- Strong, durable ABS plastic
- Accepts up to 4 Alpha Snap Outlets in a double gang
- Supplied with fixing screws
- Can be individually screen printed with custom logo

Product Description

The flat double faceplate accepts 4 single Alpha Snap modules or 2 triple Alpha Snap modules.

The Alpha Snap Faceplate is made from white ABS plastic which is fire retardant and completes any installation with a professional look.



The Double Gang Faceplates accepts 4 single modules or 2 triple modules, to offer 4 or 6 ports

Technical Data Table

Article-No.	Type	Height (H)	Width (W)	Depth (D)	Quantity	Colour
854-35224	ASFP02F/WH	86.0	147.0	10.0	22	White (WH)

All dimensions in mm. Subject to technical changes.

Plastic Mounting Hardware

Alpha Snap Single Gang Flat Faceplate

Features and Benefits

- Strong, durable ABS plastic
- Accepts up to 2 Alpha Snap Outlets in a single gang
- Supplied with fixing screws
- Can be individually screen printed with custom logo

Product Description

The flat single faceplate accepts 2 single Alpha Snap modules or 1 triple Alpha Snap module.

The Alpha Snap Faceplate is made from white ABS plastic which is fire retardant and completes any installation with a professional look.



Single Gang Faceplates can be fitted with a triple outlet module or 2 single outlet modules

Technical Data Table

Article-No.	Type	Height (H)	Width (W)	Depth (D)	Quantity	Colour
854-35210	ASFP01F/WH	86.0	86.0	10.0	25	White (WH)

All dimensions in mm. Subject to technical changes.



Plastic Mounting Hardware Easy Clip Double Gang Faceplate

Features and Benefits

- Strong, durable ABS plastic
- Accepts up to 4 Easy Clip Outlets in a double gang
- Supplied with fixing screws
- Can be individually screen printed with custom logo

Product Description

The double faceplate accepts 4 single Easy Clip modules.

The Easy Clip Faceplate is made from white ABS plastic which is fire retardant and completes any installation with a professional look.



The Double Gang Faceplates accept 4 single modules

Technical Data Table

Article-No.	Type	Height (H)	Width (W)	Depth (D)	Quantity	Colour
854-35321	ECFP02/WH	86.0	147.0	10.0	22	White (WH)

All dimensions in mm. Subject to technical changes.

Plastic Mounting Hardware Easy Clip Single Gang Faceplate

Features and Benefits

- Strong, durable ABS plastic
- Accepts up to 2 Easy Clip Outlets in a single gang
- Supplied with fixing screws
- Can be individually screen printed with custom logo

Product Description

The single faceplate accepts 2 single Easy Clip modules.

The Easy Clip Faceplate is made from white ABS plastic which is fire retardant and completes any installation with a professional look.



Single Gang Faceplates accept 2 single outlet modules

Technical Data Table

Article-No.	Type	Height (H)	Width (W)	Depth (D)	Quantity	Colour
854-35315	ECFP01/WH	86.0	86.0	10.0	25	White (WH)

All dimensions in mm. Subject to technical changes.



**Plastic Mounting Hardware
MegaBand Double Gang Faceplate**

Features and Benefits

- Strong, durable ABS plastic
- Accepts up to 4 MegaBand Outlets in a double gang
- Supplied with fixing screws
- Can be individually screen printed with custom logo

Product Description

The double faceplate accepts 4 single MegaBand modules, presenting 4 RJ45 outlets.

The MegaBand Faceplate is made from white ABS plastic which is fire retardant and completes any installation with a professional look.



The Double Gang Faceplates accept up to 4 single modules

Technical Data Table

Article-No.	Type	Height (H)	Width (W)	Depth (D)	Quantity	Colour
854-35484	MBFP02/WH	86.0	147.0	10.0	22	White (WH)

All dimensions in mm. Subject to technical changes.

**Plastic Mounting Hardware
MegaBand Single Gang Faceplate**

Features and Benefits

- Strong, durable ABS plastic
- Accepts up to 2 MegaBand Outlets in a single gang
- Supplied with fixing screws
- Can be individually screen printed with custom logo

Product Description

The single faceplate accepts 2 single MegaBand modules, presenting 2 RJ45 outlets.

The MegaBand Faceplate is made from white ABS plastic which is fire retardant and completes any installation with a professional look.



Single Gang Faceplates accept up to 2 single modules

Technical Data Table

Article-No.	Type	Height (H)	Width (W)	Depth (D)	Quantity	Colour
854-35329	MBFP01/WH	86.0	86.0	10.0	25	White (WH)

All dimensions in mm. Subject to technical changes.



Plastic Mounting Hardware

Alpha Snap Half Blanks

Features and Benefits

- White ABS plastic
- Compatible with Alpha Snap Faceplates and modules
- Half Blank - 50mm x 25mm full module size
- Blank off space within a faceplate

Product Description

The Alpha Snap Half Blank fits into both the bevelled and flat Alpha Snap Faceplates, providing a professional finish where any spaces may be left.

The blanks can be simply removed if additional outlets are required in the future.



The Half Blank can be used with faceplates to fill any voids where additional outlets are not required

Technical Data Table

Article-No.	Type	Height (H)	Width (W)	Depth (D)	Quantity	Colour
854-35174	AS050/WH	50.0	25.0	14.0	1	White (WH)

All dimensions in mm. Subject to technical changes.

Plastic Mounting Hardware

Alpha Snap Quarter Blanks

Features and Benefits

- White ABS plastic
- Compatible with Alpha Snap Faceplates and modules
- Quarter Blank - 50mm x 12.5mm half module size
- Blank off space within a faceplate

Product Description

The Alpha Snap Quarter Blank fits into both the bevelled and flat Alpha Snap Faceplates, providing a professional finish where any spaces may be left.

The blanks can be simply removed if additional outlets are required in the future.



The Quarter Blank can be used with faceplates to fill any voids where additional outlets are not required

Technical Data Table

Article-No.	Type	Height (H)	Width (W)	Depth (D)	Quantity	Colour
854-35172	AS025/WH	50.0	12.5	14.0	1	White (WH)

All dimensions in mm. Subject to technical changes.



Plastic Mounting Hardware
Easy Clip Half Blanks

Features and Benefits

- White ABS plastic
- Compatible with Easy Clip Faceplates
- Half Blank - 50mm x 25mm full module size
- Blank off space within a faceplate

Product Description

The Easy Clip Half Blank fits into the Easy Clip Faceplates, providing a professional finish where any spaces may be left.

The blanks can be simply removed if additional outlets are required in the future.



The Half Blank can be used with faceplates to fill any voids where additional outlets are not required

Technical Data Table

Article-No.	Type	Height (H)	Width (W)	Depth (D)	Quantity	Colour
854-35309	EC050/WH	50.0	25.0	14.0	1	White (WH)

All dimensions in mm. Subject to technical changes.

Plastic Mounting Hardware
Easy Clip Quarter Blanks

Features and Benefits

- White ABS plastic
- Compatible with Easy Clip Faceplates
- Half Blank - 50mm x 12.5mm half module size
- Blank off space within a faceplate

Product Description

The Easy Clip Quarter Blank fits into the Easy Clip Faceplates, providing a professional finish where any spaces may be left.

The blanks can be simply removed if additional outlets are required in the future.



The Quarter Blank can be used with faceplates to fill any voids where additional outlets are not required

Technical Data Table

Article-No.	Type	Height (H)	Width (W)	Depth (D)	Quantity	Colour
854-35753	EC025/WH	50.0	12.5	14.0	1	White (WH)

All dimensions in mm. Subject to technical changes.



Plastic Mounting Hardware MegaBand Half Blanks

Features and Benefits

- White ABS plastic
- Compatible with MegaBand Faceplates
- Half Blank - 50mm x 25mm full module size
- Blank off space within a faceplate

Product Description

The MegaBand Half Blank fits into the MegaBand Faceplates, providing a professional finish where any spaces may be left.

The blanks can be simply removed if additional outlets are required in the future.



The Half Blank can be used with faceplates to fill any voids where additional outlets are not required

Technical Data Table

Article-No.	Type	Height (H)	Width (W)	Depth (D)	Quantity	Colour
854-35482	MB050/WH	50.0	25.0	15.0	1	White (WH)

All dimensions in mm. Subject to technical changes.

Plastic Mounting Hardware MegaBand Quarter Blanks

Features and Benefits

- White ABS plastic
- Compatible with MegaBand Faceplates
- Quarter Blank - 50mm x 12.5mm half module size
- Blank off space within a faceplate

Product Description

The MegaBand Quarter Blank fits into the MegaBand Faceplates, providing a professional finish where any spaces may be left.

The blanks can be simply removed if additional outlets are required in the future.



The Quarter Blank can be used with faceplates to fill any voids where additional outlets are not required

Technical Data Table

Article-No.	Type	Height (H)	Width (W)	Depth (D)	Quantity	Colour
854-35481	MB025/WH	50.0	12.5	14.0	1	White (WH)

All dimensions in mm. Subject to technical changes.



Plastic Mounting Hardware

6C Half Blanks

Features and Benefits

- White ABS plastic
- Compatible with 6C sized faceplates and outlet apertures
- Half Blank - 50mm x 25mm full module size
- Blanks off space within a faceplate

Product Description

The 6C Half Blank fits into standard LJ6C dimension mounting apertures, providing a professional finish where any spaces may be left.

The blanks can be simply removed if additional outlets are required in the future.



The 6C Half Blank clips into the 6C Adapters and standard LJ6C mounting apertures

Technical Data Table

Article-No.	Type	Height (H)	Width (W)	Depth (D)	Quantity	Colour
852-30005	6C050	38.0	25.0	11.0	1	White (WH)

All dimensions in mm. Subject to technical changes.

Plastic Mounting Hardware

6C Adapters

Features and Benefits

- White ABS plastic
- Accepts 2 x LJ6C Outlets
- Snaps into all Alpha Snap Faceplates
- Can also be used with Angled 6C Outlets

Product Description

The 6C Adapter allows 6C sized outlets and modules to be used in the HellermannTyton Alpha Snap Faceplates and sub floor boxes.

The 6C Adapter provides space for 2 6C modules.



The 6C Adapter allows 6C modules to be fitted into Alpha Snap Faceplates

Technical Data Table

Article-No.	Type	Height (H)	Width (W)	Depth (D)	Quantity	Colour
854-35121	6C ADP	50.0	50.0	8.0	1	White (WH)

All dimensions in mm. Subject to technical changes.



GigaBand

Empty Single Category 6 Modules

Features and Benefits

- Patented slide label system
- 5 Colour options available
- Labelling software available

Product Description

The GigaBand Outlet forms part of the premium Category 6 GigaBand product range from HellermannTyton. The individual modular design of the GigaBand system allows for uncompromised performance and quality.

GigaBand modules are available in standard (25mm x 50mm) size.

6



GigaBand modules are available in a range of colours

Technical Data Table

Article-No.	Type	Performance Category	Height (H)	Width (W)	Depth (D)	Port count	Colour
852-05599	ASPMC6/BK	Category 6 (Class E)	50.0	25.0	34.0	1	Black (BK)
852-05600	ASPMC6/BL	Category 6 (Class E)	50.0	25.0	34.0	1	Blue (BU)
852-05601	ASPMC6/GN	Category 6 (Class E)	50.0	25.0	34.0	1	Green (GN)
852-05602	ASPMC6/RD	Category 6 (Class E)	50.0	25.0	34.0	1	Red (RD)
852-05326	ASPMC6/WH	Category 6 (Class E)	50.0	25.0	34.0	1	White (WH)

All dimensions in mm. Subject to technical changes

Alpha Snap

Empty Single Category 5e Modules

Features and Benefits

- Patented slide label system
- 5 colour options available
- Labelling software available

Product Description

Alpha Snap is the leading Category 5e product group within the HellermannTyton cabling system product range. Designed to offer exceptional Category 5e performance and to meet the exacting standards of mission critical installations.

The Alpha Snap Outlet is available in standard single (25mm x 50mm)

5e



Coloured Alpha Snap Category 5e modules

Technical Data Table

Article-No.	Type	Performance Category	Height (H)	Width (W)	Depth (D)	Port count	Colour
852-05615	ASPMC5/BK	Category 5E (Class D)	50.0	25.0	34.0	1	Black (BK)
852-05616	ASPMC5/BL	Category 5E (Class D)	50.0	25.0	34.0	1	Blue (BU)
852-05617	ASPMC5/GN	Category 5E (Class D)	50.0	25.0	34.0	1	Green (GN)
852-05618	ASPMC5/RD	Category 5E (Class D)	50.0	25.0	34.0	1	Red (RD)
852-05614	ASPMC5/WH	Category 5E (Class D)	50.0	25.0	34.0	1	White (WH)

All dimensions in mm. Subject to technical changes



Plastic Mounting Hardware Alpha Snap Angled Module

Features and Benefits

- Angled design allows for patch lead bend management in floor box applications
- Minimal depth in front of module
- Accepts HellermannTyton Category 6A, Category 6 and Category 5e Keystone Jacks
- Shuttered to ensure dust free operation
- Labelling field

Product Description

The Alpha Snap angled module is a low profile module that has been developed to give the user a reliable cabling outlet that reduces the space required both in front and behind the outlet.

Designed for use in the floor box to prevent crushing of the patch lead as it exits the outlet, it is equally at home in a wall or desk outlet. The Alpha Snap angled module fits into all Alpha Snap Faceplates.



The Angled Outlet is the ideal solution for areas where space and bend radius are a possible issue

Technical Data Table

Article-No.	Type	Height (H)	Width (W)	Depth (D)	Quantity	Colour
854-35228	ASFPANG/WH	50.0	25.0	27.0	1	White (WH)

All dimensions in mm. Subject to technical changes.

Plastic Mounting Hardware Easy Clip Angled Module

Features and Benefits

- Angled design allows for patch lead bend management in floor box applications
- Minimal depth in front of module
- Accepts HellermannTyton Category 6A, Category 6 and Category 5e Keystone Jacks
- Shuttered to ensure dust free operation
- Labelling field

Product Description

The Easy Clip angled module is a low profile module that has been developed to give the user a reliable cabling outlet that reduces the space required both in front and behind the outlet.

Designed for use in the floor box to prevent crushing of the patch lead as it exits the outlet, it is equally at home in a wall or desk outlet. The Easy Clip angled module fits into all Easy Clip Faceplates.



The Angled Outlet is the ideal solution for areas where space and bend radius are a possible issue

Technical Data Table

Article-No.	Type	Height (H)	Width (W)	Depth (D)	Quantity	Colour
854-39399	EC-ANG-PMO/WH	50.0	25.0	27.0	1	White (WH)

All dimensions in mm. Subject to technical changes.



Plastic Mounting Hardware

6C Angled Module

Features and Benefits

- Angled design allows for patch lead bend management in floor box applications
- Minimal depth in front of module
- Accepts HellermannTyton Category 6A, Category 6 and Category 5e Keystone Jacks
- Shuttered to ensure dust free operation
- Labelling field

Product Description

The 6C angled module is a low profile module that has been developed to give the user a reliable cabling outlet that reduces the space required both in front and behind the outlet.

Designed for use in the floor box to prevent crushing of the patch lead as it exits the outlet, it is equally at home in a wall or desk outlet. The 6C angled module fits into all industry standard LJ6C outlet apertures.



The Angled Outlet is the ideal solution for areas where space and bend radius are a possible issue

Technical Data Table

Article-No.	Type	Height (H)	Width (W)	Depth (D)	Quantity	Colour
852-30047	6C-ANG-PMO/WH	38.0	25.0	20.0	1	White (WH)

All dimensions in mm. Subject to technical changes.

Plastic Mounting Hardware

Alpha Snap Keystone Adapter

Features and Benefits

- White ABS plastic
- Available for Category 6 and Category 5e Keystone Jacks
- Snaps into both Alpha Snap and Easy Clip modules

Product Description

The Keystone Adapter has been designed to fit the HellermannTyton Keystone Jack into both Alpha Snap and Easy Clip Outlet modules.



The Keystone Adapter is available for both Alpha Snap and Easy Clip Outlets

Technical Data Table

Article-No.	Type	Height (H)	Width (W)	Depth (D)	Quantity	Colour
852-05575	KS ASPMC5E/WH	26.0	19.0	9.0	1	White (WH)
852-05576	KS ASPMC6/WH	26.0	19.0	9.0	1	White (WH)

All dimensions in mm. Subject to technical changes.



Plastic Mounting Hardware 27mm Single Back Box

Features and Benefits

- White ABS plastic
- Surface mountable
- Multiple cable entry points

Product Description

The single back box is designed to work with all single faceplates. The back box is wall mountable and has multiple punch-out cable entry points.



The Single 27mm back box is a wall mountable, low profile solution

Technical Data Table

Article-No.	Type	Height (H)	Width (W)	Depth (D)	Quantity	Colour
854-35181	ASBB01-27MM/WH	86.0	86.0	27.0	1	White (WH)

All dimensions in mm. Subject to technical changes.

Plastic Mounting Hardware 37mm Double Back Box

Features and Benefits

- ABS plastic
- Surface mountable
- Multiple cable entry points
- Deeper box for added cable protection

Product Description

The double back box is designed to work with all single faceplates. The back box is wall mountable and has multiple punch-out cable entry points.

The deeper box allows more room for cable, providing better protection and space for optimum bend radius.



The Double 37mm back box is a wall mountable and has multiple cable entry points

Technical Data Table

Article-No.	Type	Height (H)	Width (W)	Depth (D)	Quantity	Colour
854-35187	ASBB02-37MM/WH	86.0	147.0	37.0	1	White (WH)

All dimensions in mm. Subject to technical changes.



Plastic Mounting Hardware

37mm Single Back Box

Features and Benefits

- ABS plastic
- Surface mountable
- Multiple cable entry points
- Deeper box for added cable protection

Product Description

The single back box is designed to work with all single faceplates. The back box is wall mountable and has multiple punch-out cable entry points.

The deeper box allows more room for cable, providing better protection and space for optimum bend radius.



The Single 37mm back box is a wall mountable and has multiple cable entry points

Technical Data Table

Article-No.	Type	Height (H)	Width (W)	Depth (D)	Quantity	Colour
854-35183	ASBB01-37MM/WH	86.0	86.0	37.0	1	White (WH)

All dimensions in mm. Subject to technical changes.

Cable Management

Out Of Rack - 1U Space/2U RapidNet

Features and Benefits

- 600mm width for the narrowest server rack
- Adjustable vertical height
- Single person overhead installation
- Fits any 50mm pitch basket tray
- Vertical cable management into the rack or cabinet
- RapidNet ready

Product Description

This Out of Rack configuration provides 2U of space to accommodate any 6 port UTP copper and any fibre RapidNet Cassettes. The remaining 1U of space can be used to accommodate a 1U switch or other active equipment of that size.

The Out of Rack solution is designed to house the majority of the network patching and connectivity above the rack or cabinet, allowing the space within the cabinet to hold more active equipment.



This Out of Rack configuration provides 1U of space for a switch as well as 2U of RapidNet connectivity

Technical Data Table

Article-No.	Type	Height (H)	Width (W)	Depth (D)	Quantity	Colour
854-20025	RNAORC2	225.0	590.0	278.0	1	Black (BK)

All dimensions in mm. Subject to technical changes.

Technical Description

The Out of Rack solution is designed to be installed onto the overhead cable basket and is suspended above the racks, providing either additional patching for the rack or an alternative patching area to enable more space for active equipment.

There are many Out of Rack accessories available on request including gland/conduit kits, basket trays and mini patch leads.



Cable Management
Out Of Rack - 3U RapidNet

Features and Benefits

- 600mm width for the narrowest server rack
- Adjustable vertical height
- Single person overhead installation
- Fits any 50mm pitch basket tray
- Vertical cable management into the rack or cabinet
- RapidNet ready

Product Description

This Out of Rack configuration provides 3U of space to accommodate any 6 port UTP copper and any fibre RapidNet Cassettes.

The Out of Rack solution is designed to house the majority of the network patching and connectivity above the rack or cabinet, allowing the space within the cabinet to hold more active equipment.



This Out of Rack configuration offers 3U of RapidNet Connectivity

Technical Data Table

Article-No.	Type	Height (H)	Width (W)	Depth (D)	Quantity	Colour
854-20024	RNAORC1	225.0	590.0	278.0	1	Black (BK)

All dimensions in mm. Subject to technical changes.

Technical Description

The Out of Rack solution is designed to be installed onto the overhead cable basket and is suspended above the racks, providing either additional patching for the rack or an alternative patching area to enable more space for active equipment.

There are many Out of Rack accessories available on request including gland/conduit kits, basket trays and mini patch leads.

Cable Management
Out Of Rack - 3U Space

Features and Benefits

- 600mm width for the narrowest server rack
- Adjustable vertical height
- Single person overhead installation
- Fits any 50mm pitch basket tray
- Vertical cable management into the rack or cabinet
- RapidNet ready

Product Description

This Out of Rack configuration provides 3U of space to accommodate any patch panels or additional active hardware, giving the user total flexibility with the space and how it's used.

The Out of Rack solution is designed to house the majority of the network patching and connectivity above the rack or cabinet, allowing the space within the cabinet to hold more active equipment.



This Out of Rack configuration offers 3U of space to give the user maximum flexibility

Technical Data Table

Article-No.	Type	Height (H)	Width (W)	Depth (D)	Quantity	Colour
854-20026	RNAORC3	225.0	590.0	278.0	1	Black (BK)

All dimensions in mm. Subject to technical changes.

Technical Description

The Out of Rack solution is designed to be installed onto the overhead cable basket and is suspended above the racks, providing either additional patching for the rack or an alternative patching area to enable more space for active equipment.

There are many Out of Rack accessories available on request including gland/conduit kits, basket trays and mini patch leads.



Cable Management

Front Cable Management

Features and Benefits

- Manages patch leads horizontally
- 1U and 2U options available
- 5 Plastic rings
- Supplied with Rack Snaps mounting fixings

Product Description

Cable management is an important part of any installation. The 1U and 2U Front Cable Management panels come complete with five flexible plastic rings which are designed to aid installations by providing a speedy method of cable dressing.



The Front Cable Management Panel is available in both 1U and 2U sizes

Technical Data Table

Article-No.	Type	Height (H)	Width (W)	Depth (D)	Quantity	Colour
854-05028	1CTV-P/BK	44.0	484.0	75.0	1	Black (BK)
854-05041	2CTV-P/BK	44.0	484.0	83.0	1	Black (BK)

All dimensions in mm. Subject to technical changes.

Technical Description

The Front Cable Management Panel is available in both 1U and 2U sizes. Each has 5 plastic rings, which hold and support the cables

in position. It is recommended that there is provision for cable management for every 2U of cabling or patching in a cabinet or rack.

Cable Management

Rear Cable Management

Features and Benefits

- Provides cable strain relief
- Will manage up to 48 cables
- Light weight aluminium construction
- Quick and easy installation
- For use with GigaBand, Alpha Snap, Global and MegaBand Panels

Product Description

The Rear Cable Management bar fits easily onto HellermannTyton's GigaBand, Alpha Snap, Global and MegaBand Panels, providing excellent cable strain relief for rear cables. There are cable anchor points for up to 48 cables, enabling use with high density panels.



The Rear Cable Manager Bar is compatible with GigaBand, Alpha Snap, Global and Megband Patch Panels from HellermannTyton

Technical Data Table

Article-No.	Type	Height (H)	Width (W)	Depth (D)	Quantity	Colour
854-05113	CM2000G	18.0	140.0	126.0	1	Black (BK)
854-05114	CM2000HD	18.0	140.0	126.0	1	Black (BK)

All dimensions in mm. Subject to technical changes.

Technical Description

The Rear Cable Management bar is sold in two versions. The CM2000G is compatible with Global and MegaBand Panels

whereas the CM2000HD is compatible with the GigaBand and Alpha Snap Panels.



Cable Management

1U Brush Strip Panel

Features and Benefits

- Allows front to rear patching
- Helps maintains constant airflow within a cabinet
- Enables patch cords to be displayed tidily
- 1U presentation with brush strips covering cable entry space

Product Description

The 1U brush strip panel makes it possible for front to rear patching, connecting active equipment to patch panels with front presentation. The panels also provides a neat and tidy cable management solution for the cabinet or rack.



The 1U Brush Strip is ideal for front to rear connectivity within the cabinet

Technical Data Table

Article-No.	Type	Height (H)	Width (W)	Depth (D)	Quantity	Colour
854-05009	1CTLB-R/BK	44.0	484.0	2.0	1	Black (BK)

All dimensions in mm. Subject to technical changes.

Technical Description

The brush strip panel presents 2 'letter box' style holes with a brush strip attached to cover the holes. The brushes help maintain a constant airflow within the cabinet or rack.

Cable Management

Triple Rack Snaps

Features and Benefits

- Reduces time taken to install patch panels into a cabinet
- Tool-less Installation
- Suitable for rack mounting plate thicknesses between 1.2mm & 2.4mm
- M5 screw size

Product Description

The Triple Rack Snap is supplied in blocks of three, with the screws positioned to the standard patch panel size.

The easy installation of the Rack Snaps enables the installer to quickly position and secure patch panels or active equipment in the rack or cabinet.



The Triple Rack Snap is supplied with M5 screws in individual packs or packs of 100

Technical Data Table

Article-No.	Type	Height (H)	Width (W)	Depth (D)	Quantity	Colour
854-40074	RS002	44.0	14.0	19.0	1	Black (BK)
854-40077	RS100	44.0	14.0	19.0	100	Black (BK)

All dimensions in mm. Subject to technical changes.

Technical Description

The Triple Rack Snap is available individually or in packs of 100 and is supplied together with M5 screws.



Cable Management

Single Rack Snaps

Features and Benefits

- Reduces time taken to install patch panels into a cabinet
- Tool-less Installation
- Suitable for rack mounting plate thicknesses between 1.2mm & 2.4mm
- M5 screw size

Product Description

The Single Rack Snap is supplied as individual blocks and are fitted with a quality brass M5 sized gromet.

The easy installation of the Rack Snaps enables the installer to quickly position and secure patch panels or active equipment in the rack or cabinet.



The Single Rack Snap is available in packs of 50, 100 or as singles

Technical Data Table

Article-No.	Type	Height (H)	Width (W)	Depth (D)	Quantity	Colour
854-40080	RS103	16.0	14.0	19.0	1	Black (BK)
854-05151	RS103 (100)	16.0	14.0	19.0	100	Black (BK)
853-15036	RS103 (50)	16.0	14.0	19.0	50	Black (BK)

All dimensions in mm. Subject to technical changes.

Technical Description

The single Rack Snap is available individually, in packs of 50 or packs of 100 and require M5 screws. Panel installation with the Rack Snap is significantly faster than using cage nuts.

Accessories

3U Hinged Wall Bracket

Features and Benefits

- Wall mountable
- Hinged bracket
- Cable entry either top or bottom.
- Accommodates up to 3 1U patch panels

Product Description

The 3U hinged wall bracket can accommodate up to 3U of patch panels or active equipment and is the ideal solution for installations where there is only a minimum requirement for patching.



The 3U Wall box is hinged to allow easy access to the rear of the patch panel

Technical Data Table

Article-No.	Type	Height (H)	Width (W)	Depth (D)	Quantity	Colour
854-25020	WB-3U	139.0	484.0	152.0	1	Black (BK)

All dimensions in mm. Subject to technical changes.

Technical Description

The wall bracket is wall mountable with hinged mounting on one side to allow easy access to the rear of any patching or active equipment.

The wall bracket is made from 2mm mild steel with a black powder coated finish.



Accessories

2U Hinged Wall Bracket

Features and Benefits

- Wall mountable
- Hinged bracket
- Cable entry at either top or bottom
- Accommodates up to 2 1U patch panels

Product Description

The 2U hinged wall bracket can accommodate up to 2U of patch panels or active equipment and is the ideal solution for installations where there is only a minimum requirement for patching.



The 2U Wall box is hinged to allow easy access to the rear of the patch panel

Technical Data Table

Article-No.	Type	Height (H)	Width (W)	Depth (D)	Quantity	Colour
854-25015	WB-2U	94.0	484.0	154.0	1	Black (BK)

All dimensions in mm. Subject to technical changes.

Technical Description

The wall bracket is wall mountable with hinged mounting on one side to allow easy access to the rear of any patching or active equipment.

The wall bracket is made from 2mm mild steel with a black powder coated finish.

Lockable Outlets

3 Port LAN Lock Unit

Features and Benefits

- Surface mountable
- Internal patch lead fixing point
- 3 port configuration
- Supplied unloaded
- Compatible with Category 6 and Category 5e Keystone modules
- Tamper-proof screw option

Product Description

The LAN lock unit is designed to prevent unauthorised patch lead removal. It is the ideal solution for any areas with public access, for example hospitals, schools, reception areas or any place where network security is a concern.

Available in 3 or 6 port sizes, LAN lock's two part, low profile casing is moulded from sturdy ABS and will accept either UTP or FTP patch leads.

Sold unloaded requiring HellermannTyton Category 6 or Category 5e Keystone modules.



Designed to prevent patch lead removal

Technical Data Table

Article-No.	Type	Height (H)	Width (W)	Depth (D)	Port count	Quantity	Colour
854-35460	LL03U/WH/WH	25.0	86.0	120.0	3	1	White (WH)

All dimensions in mm. Subject to technical changes.

Technical Description

The LAN lock unit can be easily mounted onto most surfaces and utilises HellermannTyton's 16 and 25mm standard trunking adaptors,

incorporating rear cable entry and internal patch lead anchor points. This 3 Port version has fixings suitable for standard back boxes.



Lockable Outlets

6 Port LAN Lock Unit

Features and Benefits

- Surface mountable
- Internal patch lead fixing point
- 6 port configuration
- Supplied unloaded
- Compatible with Category 6 and Category 5e Keystone modules
- Tamper-proof screw

Product Description

The LAN lock unit is designed to prevent unauthorised patch lead removal. It is the ideal solution for any areas with public access, for example hospitals, schools, reception areas or any place where network security is a concern.

Available in 3 or 6 port sizes, LAN lock's two part, low profile casing is moulded from sturdy ABS and will accept either UTP or FTP patch leads.

Sold unloaded requiring HellermannTyton Category 6 or Category 5e Keystone modules.



Ideal solution for hospitals, schools and reception areas

Technical Data Table

Article-No.	Type	Height (H)	Width (W)	Depth (D)	Port count	Quantity	Colour
854-35465	LL06U/WH/WH	25.0	147.0	160.0	6	1	White (WH)

All dimensions in mm. Subject to technical changes.

Technical Description

The LAN lock unit can be easily mounted onto most surfaces and utilises HellermannTyton's 16 and 25mm standard trunking adaptors,

incorporating rear cable entry and internal patch lead anchor points. The 6 Port version has fixings suitable for standard back boxes.

Accessories

Sub Floor Box

Features and Benefits

- Aluminium extrusion
- Accepts single or triple Alpha Snap Outlets
- Can be used with 6C adaptor
- Cable knockouts at both ends 20/25mm

Product Description

The Sub Floor Box is an attractive easy to assemble design which can present up to 12 RJ45 outlets. This sub floor box is an ideal solution in any work area where there is a raised floor.



The Sub Floor Box offers up to 12 ports using triple outlets from the Alpha Snap range

Technical Data Table

Article-No.	Type	Height (H)	Width (W)	Depth (D)	Quantity	Colour
854-15035	AS08/12ESFB	70.0	160.0	205.0	1	White (WH)

All dimensions in mm. Subject to technical changes.

Technical Description

The sub floor box can accommodate upto 4 triple outlets or 8 single outlets, or a mixture of both depending on the users requirements. The sub floor box has cable entry points at both ends.



Accessories

Coolport Blue - Data and Voice Ports

Features and Benefits

- Data and Voice connectivity
- Plug and Play installation
- Enables quick equipment deployment in disaster recovery situations
- Provides simple and effective additional capacity
- Sleek, modern design

Product Description

The Blue Coolport is a 3 port outlet (1 x data and 2 x voice) which connects to one 4-pair cable. All 3 devices are then continuously available.

Easily mounted onto a desk or wall, Coolports are supplied singularly or in pairs as a kit including patch leads.



The Blue Coolport offers 1 Data port and 2 Voice ports from one connecting cable

Technical Data Table

Article-No.	Type	Height (H)	Width (W)	Depth (D)	Quantity	Colour
852-35080	CP3/1DA/2DV Blue	40.0	60.0	69.0	1	Blue (BU)
852-35081	CP3/1DA/2DV KIT Blue	40.0	60.0	69.0	2	Blue (BU)

All dimensions in mm. Subject to technical changes.

Technical Description

Coolports provide an instant method for adding more devices to a single cable port - ideal in emergency situations where not enough network outlets are available, or when the cost or disruption caused by installing additional cabling is prohibitive.

A Coolport is required at both the work area and patch panel.

Accessories

Coolport Purple - 2 Data Ports

Features and Benefits

- 2 x Data connectivity
- Plug and Play installation
- Enables quick equipment deployment in disaster recovery situations
- Provides simple and effective additional capacity
- Sleek, modern design

Product Description

The Purple Coolport is a 2 port outlet (2 x data) which connects to one 4-pair cable. Both connected devices are then continuously available.

Easily mounted onto a desk or wall, Coolports are supplied singularly or in pairs as a kit including patch leads.



The Purple Coolport offers 2 Data ports from one connecting cable

Technical Data Table

Article-No.	Type	Height (H)	Width (W)	Depth (D)	Quantity	Colour
852-35078	CP2/2DA Purple	40.0	60.0	69.0	1	Purple (PE)
852-35079	CP2/2DA KIT Purple	40.0	60.0	69.0	2	Purple (PE)

All dimensions in mm. Subject to technical changes.

Technical Description

Coolports provide an instant method for adding more devices to a single cable port - ideal in emergency situations where not enough network outlets are available, or when the cost or disruption caused by installing additional cabling is prohibitive.

A Coolport is required at both the work area and patch panel.



Accessories

Coolport Red - Data and Voice Ports

Features and Benefits

- 2 x Data and Voice connectivity
- Plug and Play installation
- Enables quick equipment deployment in disaster recovery situations
- Provides simple and effective additional capacity
- Sleek, modern design

Product Description

The Red Coolport is a 2 port outlet (1 x data and 1 x voice) which connects to one 4-pair cable. Both connected devices are then continuously available.

Easily mounted onto a desk or wall, Coolports are supplied singularly or in pairs as a kit including patch leads.



The Red Coolport offers 1 Data port and 1 Voice port from one connecting cable

Technical Data Table

Article-No.	Type	Height (H)	Width (W)	Depth (D)	Quantity	Colour
852-35076	CP2/1DA/1AV Red	40.0	60.0	69.0	1	Red (RD)
852-35077	CP2/1DA/1AV KIT Red	40.0	60.0	69.0	2	Red (RD)

All dimensions in mm. Subject to technical changes.

Technical Description

Coolports provide an instant method for adding more devices to a single cable port - ideal in emergency situations where not enough network outlets are available, or when the cost or disruption caused by installing additional cabling is prohibitive.

A Coolport is required at both the work area and patch panel.

Accessories

Coolport Yellow - Voice Ports

Features and Benefits

- 3 x Voice connectivity
- Plug and Play installation
- Enables quick equipment deployment in disaster recovery situations
- Provides simple and effective additional capacity
- Sleek, modern design

Product Description

The Yellow Coolport is a 3 port outlet (3 x voice) which connects to one 4-pair cable. All three connected devices are then continuously available.

Easily mounted onto a desk or wall, Coolports are supplied singularly or in pairs as a kit including patch leads.



The Yellow Coolport offers 3 Voice ports from one connecting cable

Technical Data Table

Article-No.	Type	Height (H)	Width (W)	Depth (D)	Quantity	Colour
852-35082	CP3/3DV Amber	40.0	60.0	69.0	1	Yellow (YE)
852-35083	CP3/3DV KIT Amber	40.0	60.0	69.0	2	Yellow (YE)

All dimensions in mm. Subject to technical changes.

Technical Description

Coolports provide an instant method for adding more devices to a single cable port - ideal in emergency situations where not enough network outlets are available, or when the cost or disruption caused by installing additional cabling is prohibitive.

A Coolport is required at both the work area and patch panel.



Accessories

Category 6A Termination Tool

Features and Benefits

- For use with HellermannTyton Category 6A Deca¹⁰ Jack
- Terminates and crops all 8 cores in one single action
- Manufactured with soft ergonomic grip
- Quick and easy to use

Product Description

The HellermannTyton Deca¹⁰ Keystone Jack has been designed to be 'non-punchdown'. Using the Category 6A Termination Tool all 8 terminations are made at once, helping to ensure quality and consistency of the connections and speeding up the termination process.

The single action operation terminates the conductors and crops excess cable simultaneously meaning no further operation is required.



The Deca¹⁰ Tool provides fast and simple terminations for HellermannTyton's Category 6A system

Technical Data Table

Article-No.	Type	Height (H)	Width (W)	Depth (D)	Length (L)	Quantity
854-40195	HT-KSJ08S-TT	22.7	15.5	35.5	238.0	1

All dimensions in mm. Subject to technical changes.

Technical Description

The Category 6A Termination Tool has a sprung ratchet mechanism and a soft ergonomic grip, making all Category 6A terminations as quick and easy as possible.

Accessories

Keystone Jack Palm Tool

Features and Benefits

- Compatible with all HellermannTyton UTP Keystone Jacks
- Ergonomically fits into palm
- Quick and easy to use
- Has colour coded wiring label to help avoid termination errors

Product Description

The Keystone Jack Palm Tool aids installation. The useful palm tool from HellermannTyton fits ergonomically in the hand to ease the punch down process of modular Keystone Jacks and individual Alpha Snap ports.



The hand held palm tool holds the Keystone Jack, making punching down easier

Technical Data Table

Article-No.	Type	Height (H)	Width (W)	Length (L)	Quantity	Colour
854-40073	PIPT	15.0	64.0	80.0	1	Blue (BU)

All dimensions in mm. Subject to technical changes.

Technical Description

One tool is also included in each box of 50 modular Jacks. The tool comes complete with a colour coded wiring guide to help avoid any errors during termination.



Accessories

RJ45 Dust Cover

Features and Benefits

- Fits all RJ45 ports
- Protects unused ports from dust and dirt
- Easy to insert and remove in high density applications with swing tab design
- Ideal for expensive active equipment
- Soft rubber material

Product Description

The RJ45 Dust Cover protects unused ports on active equipment and patch panels in the data centre or comms room. It fits all RJ45 ports including switches, servers, patch panels and other exposed outlets.



The RJ45 Dust Cover is ideal for unused ports in comms rooms and data centres

Technical Data Table

Article-No.	Type	Height (H)	Width (W)	Depth (D)	Quantity	Colour
854-40177	DCMJST	12.0	12.0	11.0	1	Blue (BU)

All dimensions in mm. Subject to technical changes.

Technical Description

Compact and low profile, the RJ45 Dust Cover is ideal for data centre applications such as blade servers. It is easy to insert and remove

where space is limited and is made from a soft flexible material, ensuring the Dust Cover stays firmly in position.

Accessories

MTP Fibre Cleaner

Features and Benefits

- Upto 600 cleans per pen
- Cleans both male & female connectors
- Cleans all MTP connector types

Product Description

A simple to use cleaning pen which utilises a specially designed lint free, low static ribbon tape to clean dust and debris from both male and female connector types (with or without pins).

Upto 600 cleans from each pen and the design ensures that the complete fibre area is cleaned.



MTP Fibre Cleaning Tool

Technical Data Table

Article-No.	Type	Quantity	Colour
855-15038	RNAFXCL-MTCPUS	1	Blue (BU)

All dimensions in mm. Subject to technical changes.

Technical Description

The head is inserted into the adaptor, or the un-mated connector in the special coupling. The user then turns the wheel on the top and the ribbon rotates to clean the end face of the fibre.

The special design of the ribbon means that under normal conditions solvents are not required to ensure a clean end face.



Accessories

Fibre Connector Cleaning Pen

Features and Benefits

- Over 500 cleans per pen
- Cleans both male & female connectors
- 1.25mm and 2.5mm ferrule options

Product Description

A simple to use cleaning pen which utilises a specially designed lint free, low static ribbon tape to clean dust and debris from both male and female connector types (with & without pins). Over 500 cleans from each pen and the design ensures that the complete fibre area is cleaned.

The end tip rotates while the ribbon is drawn over the face of the connector cleaning the complete face.



LC and SC Fibre Cleaning Pens

Technical Data Table

Article-No.	Type	Quantity	Colour
855-15036	RNAFXCL-LCCPUS	1	Blue (BU)
855-15037	RNAFXCL-SCCPUS	1	Blue (BU)

All dimensions in mm. Subject to technical changes.

Technical Description

The head is inserted into the adaptor, or the un-mated connector in the special coupling, the user presses the body of the cleaner forward until it 'clicks', this pulls the cleaning thread through so it is always clean. This also rotates the head through 180° across the face of the connector.

The special design of the ribbon means that under normal conditions solvents are not required to ensure a clean end face.

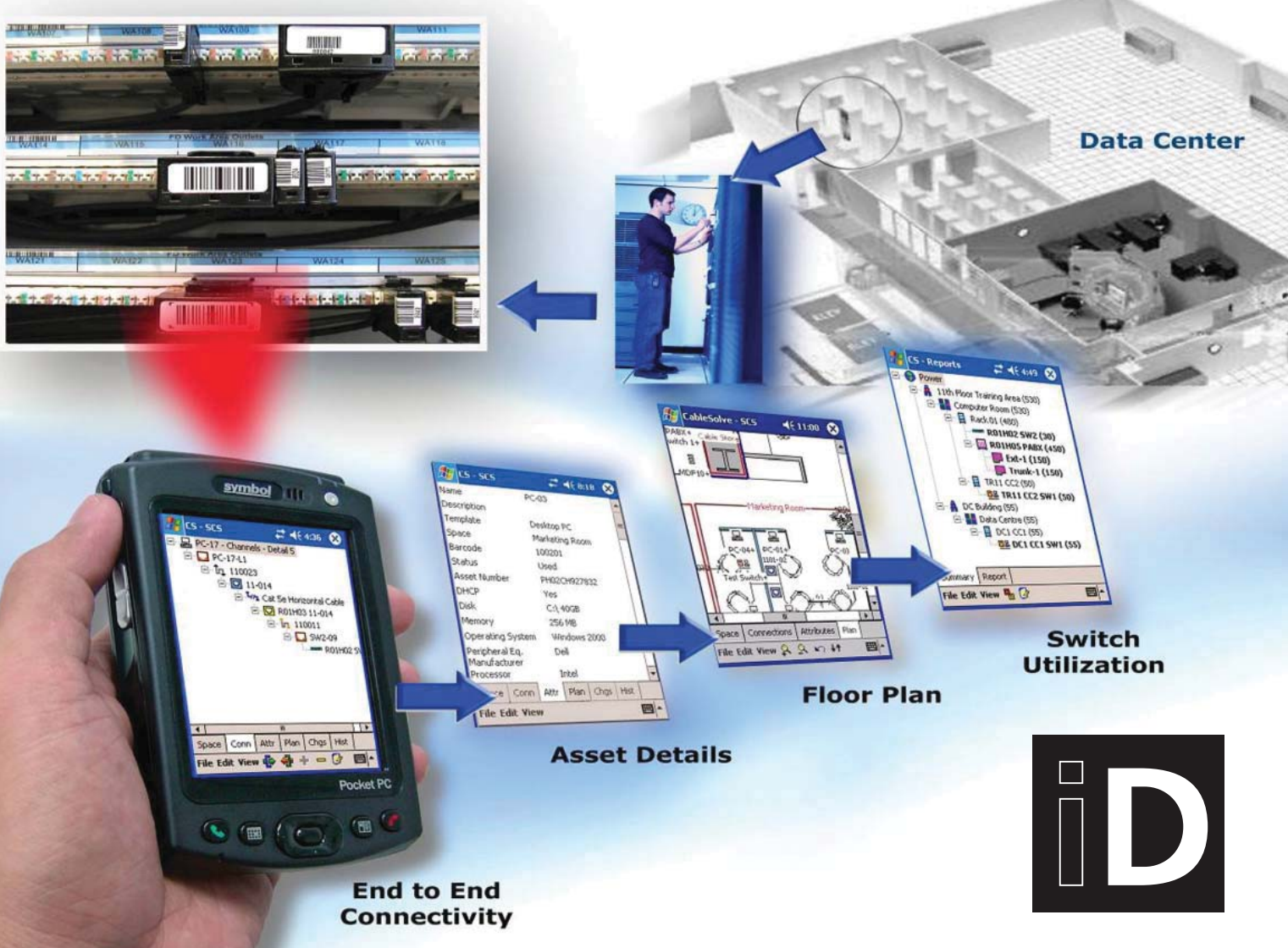

iD - Intelligent Infrastructure Management Software

Intelligent Infrastructure Management

HellermannTyton have developed the Intelligent Infrastructure Management (IIM) software, iD, to offer additional features and benefits that are designed to assist network and data centre managers.

Including all the existing features and functionality of iD, Version 6 delivers greater visibility of the network and its environment and at the same time offers the network manager additional flexibility.

Remote Web Access

iD V.6 brings together all aspects of physical layer control while providing required management information using a combination of handheld, server, desktop and web functionality. Through web access to your network, you can access and manage what you want, when you want from any remote location in real-time.

Total Visibility

iD provides visibility and control of the entire IT infrastructure. With complete visibility, significant efficiencies can be achieved with fewer equipment and infrastructure problems and reduced outages caused by incorrect change or capacity issues. Greater visibility ensures an efficient, more productive greener data centre or network.

Rack and Plan Views

iD supports rack and plan views of the infrastructure. iD automatically updates equipment moves within the infrastructure so there is always an exact representation of where things are. All graphical views are fully supported on the handheld. Capacity information can be overlaid on plan views to visually show current capacity using both static and network queried data.

Features and Benefits

- Total network visibility
- Remote web browser access
- 'Real-time' power and temperature data
- Full rack and plan views
- Intuitive trend data presentation
- SNMP scripting capability
- Intelligent data centre management solution

HellermannTyton

www.htdata.co.uk

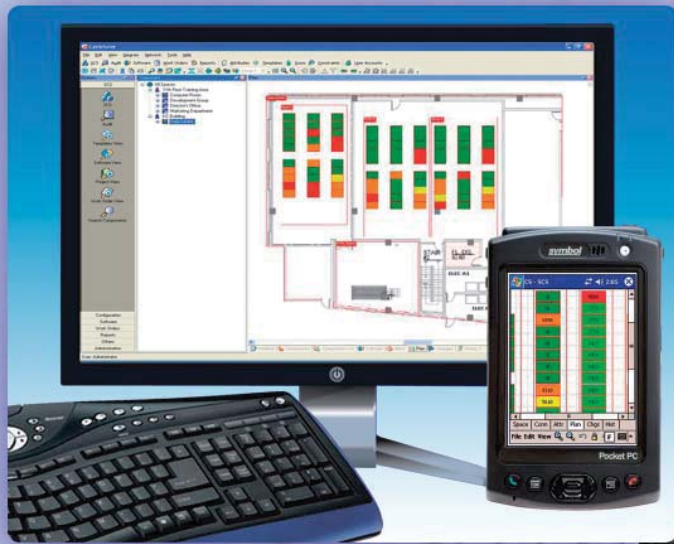

7

iD

HellermannTyton has a range of iD hardware products for use with iD Intelligent Infrastructure Management software.

	Page
7.1 iD Intelligent Infrastructure Management	
iD Category 6 Patch Leads	194
iD Category 5e Patch Leads	194
iD Category 6 Patch Panel	195
iD Category 5e Patch Panel	195
iD Alpha Snap Single Gang Faceplates	196
iD Easy Clip Single Gang Faceplates	196

	Page
7.2 iD Active	
iD Active Closet Controller	197
iD Active Category 6 Patch Panel	197
iD Active Bus Management Panel	198
iD Active Coolport Bus Manager	198



iD

Category 6 Patch Leads

Features and Benefits

- Supplied with unique bar code and test results
- Available in various lengths
- Faster problem diagnosis to reduce downtime
- Better asset utilisation
- Interface connectivity with third party systems
- Integration with iD Active Patch Panels

Product Description

The HellermannTyton iD Category 6 patch leads are supplied in a number of standard lengths but can be made to specified lengths on request. Each patch lead is supplied with it's own unique barcode identification label, and as with all HellermannTyton patch leads, are supplied with test results.

6



iD Patch Leads are supplied with individual barcodes for use with the iD software solution

Technical Data Table

Article-No.	Type	Performance Category	Length (L)	Colour
851-15682	RJ45NGB-1.0M/GY ID	Category 6 (Class E)	1.0 m	Grey (GY)
851-15683	RJ45NGB-2.0M/GY ID	Category 6 (Class E)	2.0 m	Grey (GY)
851-15684	RJ45NGB-3.0M/GY ID	Category 6 (Class E)	3.0 m	Grey (GY)
851-15686	RJ45NGB-5.0M/GY ID	Category 6 (Class E)	5.0 m	Grey (GY)
851-15970	RJ45NGB-10.0M/GY ID	Category 6 (Class E)	10.0 m	Grey (GY)

All dimensions in mm. Subject to technical changes.

Technical Description

The HellermannTyton iD Intelligent Infrastructure Solution combines sophisticated software with a range of HellermannTyton Category 5e and Category 6 products each having a unique barcode for identification.

The barcodes are read using handheld barcode scanners and the software identifies their location and end to end connectivity within the network infrastructure.

iD

Category 5e Patch Leads

Features and Benefits

- Available in Category 5e and Category 6
- Available in various lengths
- Faster diagnosis to reduce downtime
- Quickly tracks locations of assets within the facility including equipment used for short-term projects.

Product Description

The HellermannTyton iD Category 5e patch leads are supplied in a number of standard lengths but can be made to specified lengths on request. Each patch lead is supplied with it's own unique barcode identification label, and as with all HellermannTyton patch leads, are supplied with test results.

5e



iD Patch Leads are supplied with individual barcodes for use with the iD software solution

Technical Data Table

Article-No.	Type	Performance Category	Length (L)	Colour
851-10788	RJ45C5E-1.0M LSOH/GY ID	Category 5E (Class D)	1.0 m	Grey (GY)
851-10789	RJ45C5E-2.0M LSOH/GY ID	Category 5E (Class D)	2.0 m	Grey (GY)
851-10790	RJ45C5E-3.0M LSOH/GY ID	Category 5E (Class D)	3.0 m	Grey (GY)
851-10791	RJ45C5E-5.0M LSOH/GY ID	Category 5E (Class D)	5.0 m	Grey (GY)
851-10792	RJ45C5E-10.0M LSOH/GY ID	Category 5E (Class D)	10.0 m	Grey (GY)

All dimensions in mm. Subject to technical changes.

Technical Description

The HellermannTyton iD Intelligent Infrastructure Solution combines sophisticated software with a range of HellermannTyton Category 5e and Category 6 products each having a unique barcode for identification.

The barcodes are read using handheld barcode scanners and the software identifies their location and end to end connectivity within the network infrastructure.



iD

Category 6 Patch Panel

Features and Benefits

- Exceeds Category 6 performance standards
- 4 port RJ45 modules
- Supplied with Rack Snap mounting fixings
- Better asset utilisation
- Supplied with unique bar code
- Faster problem diagnosis to reduce downtime

Product Description

The Global Category 6 range of patch panels offer exceptional performance. Each panel is supplied with an iD barcode that can be used with the iD software and barcode scanners.

The Global Panel is supplied with Rack Snaps mounting fixings and a rear cable manager is also available. The Global Panel offers 2 labelling fields as standard with a magnifying lens for clear identification.



6

iD 1U Category 6 Panel is supplied with iD barcode for effective network management

Technical Data Table

Article-No.	Type	Performance Category	Height (H)	Width (W)	Depth (D)	Port count	Colour
853-45032	1/2408IDC G6 ID	Category 6 (Class E)	44.0	483.0	31.0	24	Black (BK)
853-45009	2/4808IDC G6 ID	Category 6 (Class E)	88.0	483.0	31.0	48	Black (BK)

All dimensions in mm. Subject to technical changes

Technical Description

The HellermannTyton iD Intelligent Infrastructure Solution combines sophisticated software with a range of HellermannTyton Category 5e and Category 6 products each having a unique barcode for identification.

The barcodes are read using handheld barcode scanners and the software identifies their location and end to end connectivity within the network infrastructure.

iD

Category 5e Patch Panel

Features and Benefits

- Exceeds Category 5e performance standards
- 4 port RJ45 modules
- Supplied with Rack Snap mounting fixings
- Better asset utilisation
- Supplied with unique bar code
- Faster problem diagnosis to reduce downtime

Product Description

The Global Category 5e range of patch panels offer exceptional performance. Each panel is supplied with an iD barcode that can be used with the iD software and barcode scanners.

The Global Panel is supplied with Rack Snaps mounting fixings and a rear cable manager is also available. The Global Panel offers 2 labelling fields as standard with a magnifying lens for clear identification.



5e

The iD Category 5e 1U Panel is supplied with it's own unique barcode label. Ideal for good network management.

Technical Data Table

Article-No.	Type	Performance Category	Height (H)	Width (W)	Depth (D)	Port count	Colour
853-25254	1/2408IDC G5E ID	Category 5E (Class D)	44.0	483.0	31.0	24	Black (BK)
853-25255	2/4808IDC G5E ID	Category 5E (Class D)	88.0	483.0	31.0	48	Black (BK)

All dimensions in mm. Subject to technical changes

Technical Description

The HellermannTyton iD Intelligent Infrastructure Solution combines sophisticated software with a range of HellermannTyton Category 5e and Category 6 products each having a unique barcode for identification.

The barcodes are read using handheld barcode scanners and the software identifies their location and end to end connectivity within the network infrastructure.

**iD****Alpha Snap Single Gang Faceplate****Features and Benefits**

- Available in single and double gang
- Easy Clip option available
- Interface connectivity with 3rd party systems
- Future integration with iD active patching.

Product Description

This iD Alpha Snap Single faceplate accepts 2 single Alpha Snap modules or 1 triple Alpha Snap module and is supplied with barcode labels, compatible with iD software and scanners for effective network management.

The Alpha Snap faceplate is made from white ABS plastic which is fire retardant and completes any installation with a professional look.



The iD Alpha Snap is supplied with its own barcode label for effective port identification

Technical Data Table

Article-No.	Type	Height (H)	Width (W)	Depth (D)	Colour
854-35686	ASFP01 W ID	87.0	87.0	15.0	White (WH)

All dimensions in mm. Subject to technical changes.

Technical Description

The HellermannTyton iD Intelligent Infrastructure Solution combines sophisticated software with a range of HellermannTyton Category 5e and Category 6 products each having a unique barcode for identification.

The barcodes are read using handheld barcode scanners and the software identifies their location and end to end connectivity within the network infrastructure.

iD**Easy Clip Single Gang Faceplate****Features and Benefits**

- Supplied with barcode label for use with iD software
- Strong, durable ABS plastic
- Accepts up to 2 Alpha Snap outlets in a single gang
- Offers extra 10mm depth to the backbox
- Can be individually screen printed with custom logo

Product Description

This iD Easy Clip Single faceplate accepts 2 single Easy Clip modules or 1 triple Easy Clip module and is supplied with barcode labels, compatible with iD software and scanners for effective network management.

The Easy Clip faceplate is made from white ABS plastic which is fire retardant and completes any installation with a professional look.



The iD Easy Clip Faceplate is supplied with unique barcode label for effective port identification

Technical Data Table

Article-No.	Type	Height (H)	Width (W)	Depth (D)	Colour
854-35690	ECFP01 W ID	86.0	86.0	10.0	White (WH)

All dimensions in mm. Subject to technical changes.

Technical Description

The HellermannTyton iD Intelligent Infrastructure Solution combines sophisticated software with a range of HellermannTyton Category 5e and Category 6 products each having a unique barcode for identification.

The barcodes are read using handheld barcode scanners and the software identifies their location and end to end connectivity within the network infrastructure.



iD Active Closet Controller

Features and Benefits

- Automatic, real time detection of all connections/disconnections
- Support for unlimited number of ports including remote sites
- LCD display and LED indications
- True end to end connectivity management

Product Description

The iD Active Closet Controller is a super compact (1U) panel that administers all processes of the connected iD Active Patch Panels.

Each Closet Controller is connected to the iD server via a LAN and can manage up to 100 iD Active Patch Panels.



The iD Active Closet Controller provides the hub for real-time network management

Technical Data Table

Article-No.	Type	Height (H)	Width (W)	Depth (D)	Colour
854-00000	1/CC-IDHW	44.0	483.0	140.0	Black (BK)

All dimensions in mm. Subject to technical changes.

Technical Description

iD Active is a comprehensive, standards-based, Intelligent Infrastructure Management solution offering unique end-to-end visibility and control. The software solution is arguably the most intuitive, most flexible and configurable portable solution of its kind.

It can now be coupled with intelligent microcontroller based patch panels and controllers, resulting in 100% connectivity accuracy. The complete iD solution will now track, alert and document enterprise networks in real-time.

iD Active Category 6 Active Patch Panel

Features and Benefits

- Automatic, real time detection of all connections/disconnections
- Support for unlimited number of ports including remote sites
- LED indicators signalling any connectivity errors
- True end to end connectivity management

Product Description

The iD Active Category 6 Patch Panel design is based on the well established and proven Category 6 range of patch panels. The iD Active Panel offers exceptional Category 6 performance within a high density format.

Each patch panel is a modular unit; presenting 24 ports per 1U, with the 3 PCBs each offering 8 RJ45 ports.

6

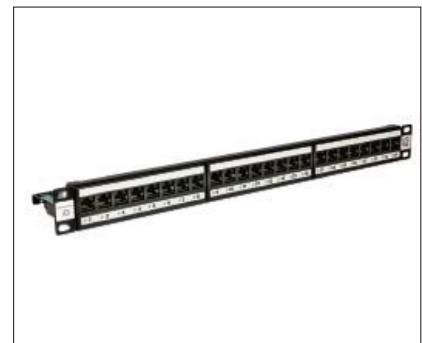

The iD Active Panel provides 24 ports in 1U with LED indicators

Technical Data Table

Article-No.	Type	Performance Category	Height (H)	Width (W)	Depth (D)	Port count	Colour
854-00001	1/2408-C6-IDHW	Category 6 (Class E)	44.0	483.0	132.0	24	Black (BK)

All dimensions in mm. Subject to technical changes

Technical Description

iD Active is a comprehensive, standards-based, Intelligent Infrastructure Management solution offering unique end-to-end visibility and control. The software solution is arguably the most intuitive, most flexible and configurable portable solution of its kind.

It can now be coupled with intelligent microcontroller based patch panels and controllers, resulting in 100% connectivity accuracy. The complete iD solution will now track, alert and document enterprise networks in real-time.



iD Active

Bus Management Panel

Features and Benefits

- Automatic, real time detection of all connections/disconnections
- Support for unlimited number of ports including remote sites
- LCD display and LED indications
- True end to end connectivity management

Product Description

The iD Active Bus Management Module is located on the rear of a 1U cable management bar to distribute the communications bus to and from all iD Active Patch Panels and the respective Closet Controller. Connectivity for up to 6 iD Active Panels is achieved by simple shielded Category 6 patch leads and RJ45 Jacks.



The iD Active Bus Manager Panel provides cable management on the front and active connectivity on the rear

Technical Data Table

Article-No.	Type	Height (H)	Width (W)	Depth (D)	Colour
854-00007	1/BM-0608-IDHW	44.0	483.0	95.0	Black (BK)

All dimensions in mm. Subject to technical changes

Technical Description

iD Active is a comprehensive, standards-based, Intelligent Infrastructure Management solution offering unique end-to-end visibility and control. The software solution is arguably the most intuitive, most flexible and configurable portable solution of its kind.

It can now be coupled with intelligent microcontroller based patch panels and controllers, resulting in 100% connectivity accuracy. The complete iD solution will now track, alert and document enterprise networks in real-time.

iD Active

Coolport Bus Manager

Features and Benefits

- Automatic, real time detection of all connections/disconnections
- Support for unlimited number of ports including remote sites
- Provides additional ports for expanded connectivity
- True end to end connectivity management

Product Description

The Coolport Bus Manager distributes the communications bus to and from all iD Active Patch Panels and the respective Closet Controller. For very compact communication cabinets the CoolPort Bus Manager may be located anywhere inside the rack and offers connectivity for up to 2 iD Active Panels using simple shielded Category 6 patch leads and RJ45 Jacks.



The iD Active Coolport Bus Manager provides additional connectivity for active networks

Technical Data Table

Article-No.	Type	Height (H)	Width (W)	Depth (D)	Colour
854-00008	CBM-0208-IDHW	40.0	60.0	69.0	Black (BK)

All dimensions in mm. Subject to technical changes

Technical Description

iD Active is a comprehensive, standards-based, Intelligent Infrastructure Management solution offering unique end-to-end visibility and control. The software solution is arguably the most intuitive, most flexible and configurable portable solution of its kind.

It can now be coupled with intelligent microcontroller based patch panels and controllers, resulting in 100% connectivity accuracy. The complete iD solution will now track, alert and document enterprise networks in real-time.

APPENDIX

8

Appendix

	Page
8.1 Alphanumerical Index	200
8.2 Numerical Index	203
8.3 Terms and Conditions	206
8.4 System Compatibility Chart	208
8.5 Panel Selection Chart and Glossary	210

Type 0408IDCG5E/WH – FLCXXS2-LCLCDY-03.0M

Type	Article-No.	Page	Type	Article-No.	Page	Type	Article-No.	Page
0408IDCG5E/WH	853-25000	119	ASBB01-27MM/WH	854-35181	179	FBAMMBG-SCSCSX-FLO01	855-20030	131
0408IDCG6/WH	852-35130	106	ASBB01-37MM/WH	854-35183	180	FBASMBL-LCLCDX-FLO01	855-20055	129
1/2408-C6-IDHW	854-00001	197	ASBB02-27MM/WH	854-35187	179	FBASMBL-LCLCOD-FLO01	855-20042	128
1/2408IDCG5E/BK	853-25017	87	ASFP01/WH	854-35202	168	FBASMBL-SCSCDX-FLO01	855-10054	130
1/2408IDC G5E ID	853-25254	195	ASFP01F/WH	854-35210	169	FBASMBL-SCSCSX-FLO01	855-20031	131
1/2408IDC G6/BK	853-45004	75	ASFP01 W ID	854-35686	196	FBCMMBG-LCXXDX-3.0WH	855-10041	132
1/2408IDC G6 ID	853-45032	195	ASFP02/WH	854-35101	168	FBCMMBG-LCXXSX-0.9WH	855-10011	133
1/2408IDCHDC5ECM/BK	853-30336	84	ASFP02F/WH	854-35224	169	FBCMMBG-LCXXSX-3.0WH	855-10026	133
1/2408IDCNGBHDCM/BK	853-40075	73	ASFP03-3LC5E/WH	852-05303	118	FBCMMBG-SCXXDX-3.0MX	855-10051	134
1/2408-NMB-HD/BK	853-20110	89	ASFP03-3L-NGB/WH	852-05305	105	FBCMMBG-SCXXSX-0.9WH	855-10032	135
1/2508VIDC4PR/BK	853-00004	98	ASFPANG/WH	854-35228	177	FBCMMBG-SCXXSX-3.0WH	855-10029	135
1/4808IDC C5E/BK	853-30339	90	ASPMC5/BK	852-05615	176	FBCSMBL-LCXXDX-3.0WH	855-10053	132
1/4808IDC C6/BK	853-35094	76	ASPMC5/BL	852-05616	176	FBCSMBL-LCXXSX-0.9WH	855-10012	133
1/5008VIDC/BK	853-00008	97	ASPMC5/GN	852-05617	176	FBCSMBL-LCXXSX-3.0WH	855-10052	133
1/BM-0608-IDHW	854-00007	198	ASPMC5/RD	852-05618	176	FBCSMBL-SCXXDX-3.0MX	855-14222	134
1/CC-IDHW	854-00000	197	ASPMC5/WH	852-05614	176	FBCSMBL-SCXXSX-0.9WH	855-10045	135
1/CTLB-R/BK	854-05009	183	ASPMC6/BK	852-05599	176	FBCSMBL-SCXXSX-3.0WH	855-10046	135
1/CTV-P/BK	854-05028	182	ASPMC6/BL	852-05600	176	FBPDBKL-LCMMDX-24VF1	855-00221	145
1U 24P J/J A/S HD C5E PANEL BK	853-30034	85	ASPMC6/GN	852-05601	176	FBPDBKL-LCMMQD-24VF1	855-00266	145
2/4808IDCG5E/BK	853-25031	86	ASPMC6/RD	852-05602	176	FBPDBKL-LCSMDX-24VF1	855-00222	145
2/4808IDC G5E ID	853-25255	195	ASPMC6/WH	852-05326	176	FBPDBKL-LCSMQD-24VF1	855-00268	145
2/4808IDCG6/BK	853-45009	74,195	CA075	851-05011	150	FBPDBKL-SCMMDX-24VF1	855-00218	146
2/4808IDCHDC5ECM/BK	853-25034	83	CA076	851-05012	148	FBPDBKL-SCSMDX-24VF1	855-00219	146
2/4808IDCNGBHDCM/BK	853-40107	72	CA079	851-05013	151	FBTXOM3-LCXXSW-01.0M	855-25033	136
2/4808-NMB-HD/BK	853-20111	88	CA082	851-05014	151	FBTXOM3-SCXXSW-01.0M	855-25028	136
2/CTV-P/BK	854-05041	182	CA083	851-05015	151	FBTXOS1-LCXXSW-01.0M	855-25009	136
6C050	852-30005	175	CA085	851-05016	149	FBTXOS1-SCXXSW-01.0M	855-25017	136
6C08IDCC5E-MSK/BK	852-30055	115	CA086	851-05017	152	FLCXXM3-LCLCDA-01.0M	855-30425	163
6C08IDCC5E-MSK/WH	852-30054	115	CA113	851-05020	150	FLCXXM3-LCLCDA-02.0M	855-30426	163
6C08IDCNGB-MSK/BK	852-30053	104	CA120	851-05036	149	FLCXXM3-LCLCDA-03.0M	855-30427	163
6C08IDCNGB-MSK/WH	852-30019	104	CA159	851-05049	148	FLCXXM3-LCLCDA-05.0M	855-30429	163
6C ADP	854-35121	175	CBM-0208-IDHW	854-00008	198	FLCXXM3-LCLCDA-10.0M	855-30447	163
6C-ANG-C5E/WH	852-30039	120	CM2000G	854-05113	182	FLCXXM3-SCSCDA-01.0M	855-30148	164
6C-ANG-C6/WH	852-30037	107	CM2000HD	854-05114	182	FLCXXM3-SCSCDA-02.0M	855-30309	164
6C-ANG-PMO/WH	852-30047	178	CP2/1DA/1AV KIT Red	852-35077	188	FLCXXM3-SCSCDA-03.0M	855-30206	164
AS025/WH	854-35172	172	CP2/1DA/1AV Red	852-35076	188	FLCXXM3-SCSCDA-05.0M	855-30448	164
AS050/WH	854-35174	172	CP2/2DA KIT Purple	852-35079	187	FLCXXM3-SCSCDA-10.0M	855-30449	164
AS08/12ESFB	854-15035	186	CP2/2DA Purple	852-35078	187	FLCXXM4-LCLCDA-01.0M	855-30920	163
AS08IDCNGB/BK	852-05184	102	CP3/1DA/2DV Blue	852-35080	187	FLCXXM4-LCLCDA-02.0M	855-30921	163
AS08IDCNGB/BL	852-05506	102	CP3/1DA/2DV KIT Blue	852-35081	187	FLCXXM4-LCLCDA-03.0M	855-30922	163
AS08IDCNGB/GN	852-05587	102	CP3/3DV Amber	852-35082	188	FLCXXM4-LCLCDA-05.0M	855-30923	163
AS08IDCNGB/RD	852-05577	102	CP3/3DV KIT Amber	852-35083	188	FLCXXM4-LCLCDA-10.0M	855-30924	163
AS08IDCNGB/WH	852-05185	101	DCMJST	854-40177	190	FLCXXM4-SCSCDA-01.0M	855-30925	164
AS08IDCNGBSLD/BK	852-05186	110	EC025/WH	854-35753	173	FLCXXM4-SCSCDA-02.0M	855-30926	164
AS08IDCNGBSLD/BL	852-05594	110	EC050/WH	854-35309	173	FLCXXM4-SCSCDA-03.0M	855-30927	164
AS08IDCNGBSLD/GN	852-05595	110	EC08IDCNGB/BK	852-05380	103	FLCXXM4-SCSCDA-05.0M	855-30928	164
AS08IDCNGBSLD/RD	852-05596	110	EC08IDCNGB/WH	852-05381	103	FLCXXM4-SCSCDA-10.0M	855-30929	164
AS08IDCNGBSLD/WH	852-05187	109	EC08IDCNGBSLD/BK	852-05582	111	FLCXXS1-LCLCDY-01.0M	855-30156	164
AS08J-J-C5E/WH	852-05197	116	EC08IDCNGBSLD/WH	852-05382	111	FLCXXS1-LCLCDY-02.0M	855-30015	164
AS08KBC5E/BK	852-05603	113	EC08KBC5E/BK	852-05611	114	FLCXXS1-LCLCDY-03.0M	855-30272	164
AS08KBC5E/BL	852-05604	113	EC08KBC5E/WH	852-05386	114	FLCXXS1-LCLCDY-05.0M	855-30157	164
AS08KBC5E/GN	852-05605	113	EC08KBC5ESLD/BK	852-05613	125	FLCXXS1-LCLCDY-10.0M	855-30450	164
AS08KBC5E/RD	852-05606	113	EC08KBC5ESLD/WH	852-05612	125	FLCXXS1-SCSCDY-01.0M	855-30093	165
AS08KBC5E/WH	852-05237	112	EC-ANG-PMO/WH	854-39399	177	FLCXXS1-SCSCDY-02.0M	855-30094	165
AS08KBLPC5E/WH	852-05267	117	ECFP01/WH	854-35315	170	FLCXXS1-SCSCDY-03.0M	855-30095	165
AS08PBC5ESLD/BK	852-05607	124	ECFP01 W ID	854-35690	196	FLCXXS1-SCSCDY-05.0M	855-30096	165
AS08PBC5ESLD/BL	852-05608	124	ECFP02/WH	854-35321	170	FLCXXS1-SCSCDY-10.0M	855-30451	165
AS08PBC5ESLD/GN	852-05609	124	FBAMMBG-LCLCDX-FLO01	855-10049	129	FLCXXS2-LCLCDY-01.0M	855-30909	164
AS08PBC5ESLD/RD	852-05610	124	FBAMMBG-LCLCOD-FLO01	855-20041	128	FLCXXS2-LCLCDY-02.0M	855-30910	164
AS08PBC5ESLD/WH	852-05275	123	FBAMMBG-SCSCDX-FLO01	855-10055	130	FLCXXS2-LCLCDY-03.0M	855-30911	164

Type FLCXS2-LCLCDY-05.0M – RJ45NGB-2.0MGN

Type	Article-No.	Page	Type	Article-No.	Page	Type	Article-No.	Page
FLCXS2-LCLCDY-05.0M	855-30912	164	PP110C612V	853-50001	82	RJ45C5E-5.0M LSOH/GY ID	851-10791	194
FLCXS2-LCLCDY-10.0M	855-30913	164	PP110C624	853-50002	80	RJ45C6AGY-1.0M	851-30000	152
FLCXS2-SCSCDY-01.0M	855-30914	165	PP110C648	853-50003	79	RJ45C6AGY-10.0M	851-30005	152
FLCXS2-SCSCDY-02.0M	855-30915	165	PP110C6481U	853-50011	81	RJ45C6AGY-2.0M	851-30001	152
FLCXS2-SCSCDY-03.0M	855-30916	165	PP24G6A-PA1URS-FD.XX	853-55000	70	RJ45C6AGY-3.0M	851-30002	152
FLCXS2-SCSCDY-05.0M	855-30917	165	PP24G6A-PA1URS-SL.XX	853-55001	71	RJ45C6AGY-5.0M	851-30004	152
FLCXS2-SCSCDY-10.0M	855-30918	165	RJ45C5E-1.0M/BL	851-10223	158	RJ45FC3-BLK	852-25016	126
FLS12M3-MFLFDA-10.0M	860-00030	139	RJ45C5E-1.0M/GN	851-10225	158	RJ45FC3-BLU	852-25017	126
FLS12M3-MFMFXA-10.0M	860-00020	144	RJ45C5E-1.0M/GY	851-10226	159	RJ45FC3-BRN	852-25018	126
FLS12M4-MFLFDA-10.0M	860-00028	138	RJ45C5E-1.0M/RD	851-10228	159	RJ45FC3-FW	852-25020	126
FLS12M4-MFMFXA-10.0M	860-00017	143	RJ45C5E-1.0M/YL	851-10232	160	RJ45FC3-GRN	852-25021	126
FLS12S1-MFLFDY-10.0M	860-00043	139	RJ45C5E-1.0M/GN	851-10749	156	RJ45FC3-GRY	852-25022	126
FLS12S1-MFMFXA-10.0M	860-00023	144	RJ45C5E-1.0M/BL	851-10748	157	RJ45FC3-I	852-25023	126
FLS24M3-MFLFDA-10.0M	860-00036	137	RJ45C5E-1.0M/YL	851-10781	157	RJ45FC3-ORN	852-25024	126
FLS24M4-MFLFDA-10.0M	860-00034	137	RJ45C5E-1.0M/BL	851-10813	155	RJ45FC3-RED	852-25025	126
FLS24S1-MFLFDY-10.0M	860-00045	138	RJ45C5E-1.0M/BL	851-10682	156	RJ45FC3-VIO	852-25026	126
FLS24S1-MFMFXA-10.0M	860-00014	143	RJ45C5E-1.0M LSOH/GY ID	851-10788	194	RJ45FC3-W	852-25027	126
FLX24M3-MFMFXA-10.0M	860-00011	142	RJ45C5E-10.0M/BL	851-10244	158	RJ45FC3-YEL	852-25028	126
FLX24M4-MFMFXA-10.0M	860-00008	142	RJ45C5E-10.0M/GN	851-10245	158	RJ45FC5E-BLK	852-25036	122
HT2408PB-U5E-M/BK	853-35056	91	RJ45C5E-10.0M/GY	851-10246	159	RJ45FC5E-BLU	852-25037	122
HT2408PB-UC6-M/BK	853-50021	77	RJ45C5E-10.0M/RD	851-10247	159	RJ45FC5E-BRN	852-25040	122
HT-KS08S-TT	854-40195	189	RJ45C5E-10.0M/YL	851-10248	160	RJ45FC5E-FW	852-25044	122
HT-OM3-12-LT	855-40071	161	RJ45C5E-10.0M/GN	851-10780	156	RJ45FC5E-GRN	852-25045	122
HT-OM3-12-TB	855-40091	162	RJ45C5E-10.0M/BL	851-10777	156	RJ45FC5E-GRY	852-25046	122
HT-OM3-24-LT	855-40073	161	RJ45C5E-10.0M/RD	851-10774	157	RJ45FC5E-I	852-25047	122
HT-OM3-24-TB	855-40093	162	RJ45C5E-10.0M/BL	851-10776	155	RJ45FC5E-ORN	852-25048	122
HT-OM3-4-LT	855-40069	161	RJ45C5E-10.0M LSOH/GY ID	851-10792	194	RJ45FC5E-RED	852-25049	122
HT-OM3-4-TB	855-40089	162	RJ45C5E-10.0M/YL	851-10783	157	RJ45FC5E-VIO	852-25059	122
HT-OM3-8-LT	855-40070	161	RJ45C5E-2.0M/BL	851-10263	158	RJ45FC5E-W	852-25060	122
HT-OM3-8-TB	855-40090	162	RJ45C5E-2.0M/GN	851-10268	158	RJ45FC5E-YEL	852-25061	122
HT-OM4-12-LT	855-40111	160	RJ45C5E-2.0M/GY	851-10270	159	RJ45FC6-BLK	852-25064	108
HT-OM4-12-TB	855-40113	162	RJ45C5E-2.0M/RD	851-10272	159	RJ45FC6-BLU	852-25065	108
HT-OM4-24-LT	855-40112	160	RJ45C5E-2.0M/YL	851-10279	160	RJ45FC6-BRN	852-25067	108
HT-OM4-24-TB	855-40114	162	RJ45C5E-2.0M/GN	851-10751	156	RJ45FC6-FW	852-25069	108
HT-OS1-12-LT	855-40076	161	RJ45C5E-2.0M LSOH/BL	851-10698	155	RJ45FC6-GRN	852-25070	108
HT-OS1-12-TB	855-40096	163	RJ45C5E-2.0M LSOH/RD	851-10700	157	RJ45FC6-GRY	852-25071	108
HT-OS1-24-LT	855-40078	161	RJ45C5E-2.0M LSOH/GY	851-10685	156	RJ45FC6-I	852-25072	108
HT-OS1-24-TB	855-40098	163	RJ45C5E-2.0M LSOH/GY ID	851-10789	194	RJ45FC6-ORN	852-25073	108
HT-OS1-4-LT	855-40074	161	RJ45C5E-2.0M LSOH/YL	851-10281	157	RJ45FC6-RED	852-25074	108
HT-OS1-4-TB	855-40094	163	RJ45C5E-3.0M/BL	851-10301	158	RJ45FC6-VIO	852-25080	108
HT-OS1-8-LT	855-40075	161	RJ45C5E-3.0M/GN	851-10303	158	RJ45FC6-W	852-25081	108
HT-OS1-8-TB	855-40095	163	RJ45C5E-3.0M/GY	851-10304	159	RJ45FC6-YEL	852-25082	108
KS ASPMC5E/WH	852-05575	178	RJ45C5E-3.0M/RD	851-10306	159	RJ45NGB-1.0M/GREEN	851-15236	153
KS ASPMC6/WH	852-05576	178	RJ45C5E-3.0M/YL	851-10309	160	RJ45NGB-1.0M/GY	851-15233	154
KSJ08SC6A	852-40000	100	RJ45C5E-3.0M/GN	851-10778	156	RJ45NGB-1.0M/GY ID	851-15682	194
KSJ08SC6A-12	852-40002	100	RJ45C5E-3.0M LSOH/BL	851-10699	155	RJ45NGB-1.0M/RD	851-15241	154
LL03U/WH/WH	854-35460	185	RJ45C5E-3.0M LSOH/GY	851-10310	156	RJ45NGB-1.0M/YL	851-15243	155
LL06U/WH/WH	854-35465	186	RJ45C5E-3.0M LSOH/GY ID	851-10790	194	RJ45NGB-1.0M/BL	851-15235	153
MB025/WH	854-35481	174	RJ45C5E-3.0M LSOH/RD	851-10311	157	RJ45NGB-10.0M/GN	851-15981	153
MB050/WH	854-35482	174	RJ45C5E-3.0M LSOH/YL	851-10312	157	RJ45NGB-10.0M/GY	851-15983	154
MB08IDCC5E/WH	852-10010	121	RJ45C5E-5.0M/BL	851-10334	158	RJ45NGB-10.0M/GY ID	851-15970	194
MBFP01/WH	854-35329	171	RJ45C5E-5.0M/GN	851-10337	158	RJ45NGB-10.0M/RD	851-15257	154
MBFP02/WH	854-35484	171	RJ45C5E-5.0M/GY	851-10338	159	RJ45NGB-10.0M/YL	851-15404	155
NGM2408IDC-55E/BK	853-35090	92	RJ45C5E-5.0M LSOH/YL	851-10378	157	RJ45NGB-10.0M/BL	851-15255	153
NGM2408IDC-56/BK	853-35104	78	RJ45C5E-5.0M/RD	851-10340	159	RJ45NGB-2.0M/GY	851-15270	154
PIPT	854-40073	189	RJ45C5E-5.0M/YL	851-10343	160	RJ45NGB-2.0M/GY ID	851-15683	194
PP110C5E12V	853-20074	96	RJ45C5E-5.0M/BL	851-10775	155	RJ45NGB-2.0M/RD	851-15274	154
PP110C5E24	853-20075	94	RJ45C5E-5.0M/GN	851-10779	156	RJ45NGB-2.0M/YL	851-15276	155
PP110C5E48	853-20078	93	RJ45C5E-5.0M/BL	851-10773	157	RJ45NGB-2.0M/BL	851-15268	153
PP110C5E481U	853-15047	95	RJ45C5E-5.0M LSOH/GY	851-10611	156	RJ45NGB-2.0MGN	851-15269	153

Type RJ45NGB-3.0M/GREEN – WB-3U

Type	Article-No.	Page	Type	Article-No.	Page	Type	Article-No.	Page
RJ45NGB-3.0M/GREEN	851-15284	153	RNAORC2	854-20025	180	RNFTD-24LCSFS1-10.0M	859-21660	54
RJ45NGB-3.0M/GY	851-15285	154	RNAORC3	854-20026	181	RNFTD24-LFLFM3-10.0M	859-21266	140
RJ45NGB-3.0M/GY ID	851-15684	194	RN BLANK	851-40196	66	RNFTD24-LFLFS1-10.0M	859-21303	140
RJ45NGB-3.0M/RD	851-15289	154	RNCC5	859-10001	65	RNFTD48-LFLFM3-10.0M	859-21267	140
RJ45NGB-3.0M/YELLOW	851-15291	155	RNCC6	859-35000	65	RNFTD48-LFLFS1-10.0M	859-21304	140
RJ45NGB-3.0MBL	851-15283	153	RNCCC	859-35001	65	RNFTD48-SFSFM3-10.0M	859-21736	141
RJ45NGB-5.0M/BLUE	851-15305	153	RNFT672-MCLFM3-10.0M	860-00168	49	RNFTD48-SFSFS1-10.0M	859-21740	141
RJ45NGB-5.0M/GREEN	851-15306	153	RNFT672-MCLFM4-10.0M	860-00169	49	RNFTD96-LFLFM3-10.0M	859-21269	140
RJ45NGB-5.0M/GY	851-15224	154	RNFT672-MCLFS1-10.0M	860-00167	49	RNFTD96-LFLFS1-10.0M	859-21306	140
RJ45NGB-5.0M/GY ID	851-15686	194	RNFT672-MCMCM3-10.0M	860-00106	47	RNFTD96-SFSFM3-10.0M	859-21737	141
RJ45NGB-5.0M/RD	851-15310	154	RNFT672-MCMCM4-10.0M	860-00000	47	RNFTD96-SFSFS1-10.0M	859-21741	141
RJ45NGB-5.0M/YL	851-15312	155	RNFT672-MCMCS1-10.0M	860-00047	47	RNFTDH4-LFLFM3-10.0M	859-21270	140
RN04-2408-UL	859-30013	63	RNFT672-MCMDM3-10.0M	860-00159	48	RNFTDH4-LFLFS1-10.0M	859-21307	140
RN04-BLANK	859-35134	66	RNFT672-MCMDM4-10.0M	860-00160	48	RNFTDH4-SFSFM3-10.0M	859-21738	141
RN04U5E-CABEXX-10.0M	859-10839	42	RNFT672-MCMDS1-10.0M	860-00158	48	RNFTDH4-SFSFS1-10.0M	859-21742	141
RN04U5E-CACAXX-10.0M	859-05417	38	RNFT6H4-MCMCM3-10.0M	860-00153	43	RNFTS24-SFSFM3-10.0M	859-21279	141
RN04U5E-CAKJXX-10.0M	859-37952	39	RNFT6H4-MCMCM4-10.0M	860-00154	43	RNFTS24-SFSFS1-10.0M	859-21315	141
RN04U5E-CAPLXX-10.0M	859-40872	40	RNFT6H4-MCMCS1-10.0M	860-00152	43	RNFTVH4-MCMCM3-10.0M	860-00156	44
RN04U5E-CAPOXX-10.0M	859-00318	41	RNFT6H4-MCMDM3-10.0M	860-00162	45	RNFTVH4-MCMCM4-10.0M	860-00157	44
RN04UC6-CABEXX-10.0M	859-10285	32	RNFT6H4-MCMDM4-10.0M	860-00163	45	RNFTVH4-MCMCS1-10.0M	860-00155	44
RN04UC6-CACAXX-10.0M	859-05415	28	RNFT6H4-MCMDS1-10.0M	860-00161	45	RNFTVH4-MCMDM3-10.0M	860-00165	46
RN04UC6-CAKJXX-10.0M	859-35950	29	RNFTD12-LCLCM3-10.0M	859-20622	55	RNFTVH4-MCMDM4-10.0M	860-00166	46
RN04UC6-CAPLXX-10.0M	859-40084	30	RNFTD-12LCLCM4-10.0M	859-21653	55	RNFTVH4-MCMDS1-10.0M	860-00164	46
RN04UC6-CAPOXX-10.0M	859-35339	31	RNFTD12-LCLCS1-10.0M	859-20832	55	RN-MESH Kit	859-35007	67
RN06G6A-CABEXX-10.0M	859-51097	17	RNFTD12-LCLFM3-10.0M	859-20799	57	RNSFB-1	859-35050	66
RN06G6A-CACAXX-10.0M	859-50019	14	RNFTD12-LCLFM4-10.0M	859-21655	57	RNSFB-3	859-35064	66
RN06G6A-CAKJXX-10.0M	859-35541	15	RNFTD12-LCLFS1-10.0M	859-21255	57	RS002	854-40074	183
RN06G6A-CAPLXX-10.0M	859-36882	16	RNFTD12-LCLMM3-XX.XX	859-21664	56	RS100	854-40077	183
RN06U5E-CABEXX-10.0M	859-10330	37	RNFTD12-LCLMM4-XX.XX	859-21665	56	RS103	854-40080	184
RN06U5E-CACAXX-10.0M	859-05490	33	RNFTD12-LCLMMS1-XX.XX	859-21663	56	RS103 (100)	854-05151	184
RN06U5E-CAKJXX-10.0M	859-35546	34	RNFTD-12LCSFM3-10.0M	859-21658	58	RS103 (50)	853-15036	184
RN06U5E-CAPLXX-10.0M	859-40137	35	RNFTD-12LCSFM4-10.0M	859-21659	58	TRO01-V2	859-35027	67
RN06U5E-CAPOXX-10.0M	859-00199	36	RNFTD-12LCSFS1-10.0M	859-21657	58	WB-2U	854-25015	185
RN06UC6-CABEXX-10.0M	859-10291	27	RNFTD12-LFLFM3-10.0M	859-21024	140	WB-3U	854-25020	184
RN06UC6-CACAXX-10.0M	859-05628	23	RNFTD12-LFLFS1-10.0M	859-21302	140			
RN06UC6-CAKJXX-10.0M	859-35448	24	RNFTD-12SCMMM3-XX.XX	859-21673	60			
RN06UC6-CAPLXX-10.0M	859-40307	25	RNFTD-12SCMMM4-XX.XX	859-21674	60			
RN06UC6-CAPOXX-10M	859-00260	26	RNFTD-12SCMMS1-XX.XX	859-21672	60			
RN12UC6-CABEXX-10.0M	859-35578	22	RNFTD-12SCSCM3-10.0M	859-20917	59			
RN12UC6-CACAXX-10.0M	859-06004	18	RNFTD-12SCSCM4-10.0M	859-21669	59			
RN12UC6-CAPLXX-10.0M	859-40325	19	RNFTD-12SCSCS1-10.0M	859-20639	59			
RN12UC6-CASC02-10.0M	859-06005	20	RNFTD-12SCSFM3-10.0M	859-21253	61			
RN12UC6-CASPO2-10.0M	859-00352	21	RNFTD-12SCSFM4-10.0M	859-21671	61			
RNA6G6A-PA1UCN-XX.XX	859-50852	63	RNFTD-12SCSFS1-10.0M	859-21670	61			
RNA6G6A-PA1URS-XX.XX	859-50851	63	RNFTD12-SFSFM3-10.0M	859-21735	141			
RNA6UXX-PA1UCN-XX.XX	859-30022	62	RNFTD12-SFSFS1-10.0M	859-21739	141			
RNA6UXX-PA1URS-XX.XX	859-30019	62	RNFTD-24LC1MM3-XX.XX	859-21680	52			
RNA6UXX-PB1UCN-XX.XX	859-30048	64	RNFTD-24LC1MM4-XX.XX	859-21681	52			
RNA6UXX-PB1URS-XX.XX	859-30047	64	RNFTD-24LC1MS1-XX.XX	859-21679	52			
RNAD-BLANK	854-40266	66	RNFTD24-LCLCM3-10.0M	859-20624	50			
RNADUXX-PA1UCN-XX.XX	859-30045	62	RNFTD24-LCLCM4-10.0M	859-21654	50			
RNADUXX-PA1URS-XX.XX	859-30033	62	RNFTD24-LCLCS1-10.0M	859-20875	50			
RNAFXCL-LCCPUS	855-15036	191	RNFTD24-LCLFM3-10.0M	859-20805	53			
RNAFXCL-MTCPUS	855-15038	190	RNFTD-24LCLFM4-10.0M	859-21656	53			
RNAFXCL-SCCPUS	855-15037	191	RNFTD24-LCLFS1-10.0M	859-21254	53			
RNAHUXX-PA1UCN-HH.SS	859-30049	64	RNFTD-24LCMMM3-XX.XX	859-21667	51			
RNAHUXX-PA1UCN-HS.HS	859-30050	64	RNFTD-24LCMMM4-XX.XX	859-21668	51			
RNAHUXX-PA1URS-HH.SS	859-30042	64	RNFTD-24LCMMS1-XX.XX	859-21666	51			
RNAHUXX-PA1URS-HS.HS	859-30043	64	RNFTD-24LCSFM3-10.0M	859-21661	54			
RNAORC1	854-20024	181	RNFTD-24LCSFM4-10.0M	859-21662	54			

Article-No. 851-05011 – 852-25080

Article-No.	Type	Page	Article-No.	Type	Page	Article-No.	Type	Page
851-05011	CA075	150	851-10789	RJ45C5E-2.0M LSOH/GY ID	194	852-05582	EC08IDCNGBSLD/BK	111
851-05012	CA076	148	851-10790	RJ45C5E-3.0M LSOH/GY ID	194	852-05587	AS08IDCNGB/GN	102
851-05013	CA079	151	851-10791	RJ45C5E-5.0M LSOH/GY ID	194	852-05594	AS08IDCNGBSLD/BL	110
851-05014	CA082	151	851-10792	RJ45C5E-10.0M LSOH/GY ID	194	852-05595	AS08IDCNGBSLD/GN	110
851-05015	CA083	151	851-10813	RJ45C5E-1.0MLSBL	155	852-05596	AS08IDCNGBSLD/RD	110
851-05016	CA085	149	851-15224	RJ45NGB-5.0M/GY	154	852-05599	ASPMC6/BK	176
851-05017	CA086	152	851-15235	RJ45NGB-1.0MBL	153	852-05600	ASPMC6/BL	176
851-05020	CA113	150	851-15236	RJ45NGB-1.0M/GREEN	153	852-05601	ASPMC6/GN	176
851-05036	CA120	149	851-15241	RJ45NGB-1.0M/RD	154	852-05602	ASPMC6/RD	176
851-05049	CA159	148	851-15243	RJ45NGB-1.0M/YL	155	852-05603	AS08KBC5E/BK	113
851-10223	RJ45C5E-1.0M/BL	158	851-15255	RJ45NGB-10.0MBL	153	852-05604	AS08KBC5E/BL	113
851-10225	RJ45C5E-1.0M/GN	158	851-15257	RJ45NGB-10.0M/RD	154	852-05605	AS08KBC5E/GN	113
851-10226	RJ45C5E-1.0M/GY	159	851-15268	RJ45NGB-2.0MBL	153	852-05606	AS08KBC5E/RD	113
851-10228	RJ45C5E-1.0M/RD	159	851-15269	RJ45NGB-2.0MGN	153	852-05607	AS08PBC5ESLD/BK	124
851-10232	RJ45C5E-1.0M/YL	160	851-15270	RJ45NGB-2.0M/GY	154	852-05608	AS08PBC5ESLD/BL	124
851-10244	RJ45C5E-10.0M/BL	158	851-15274	RJ45NGB-2.0M/RD	154	852-05609	AS08PBC5ESLD/GN	124
851-10245	RJ45C5E-10.0M/GN	158	851-15276	RJ45NGB-2.0M/YL	155	852-05610	AS08PBC5ESLD/RD	124
851-10246	RJ45C5E-10.0M/GY	159	851-15283	RJ45NGB-3.0MBL	153	852-05611	EC08KBC5E/BK	114
851-10247	RJ45C5E-10.0M/RD	159	851-15284	RJ45NGB-3.0M/GREEN	153	852-05612	EC08KBC5ESLD/WH	125
851-10248	RJ45C5E-10.0M/YL	160	851-15285	RJ45NGB-3.0M/GY	154	852-05613	EC08KBC5ESLD/BK	125
851-10263	RJ45C5E-2.0M/BL	158	851-15289	RJ45NGB-3.0M/RD	154	852-05614	ASPMC5/WH	176
851-10268	RJ45C5E-2.0M/GN	158	851-15291	RJ45NGB-3.0M/YELLOW	155	852-05615	ASPMC5/BK	176
851-10270	RJ45C5E-2.0M/GY	159	851-15305	RJ45NGB-5.0M/BLUE	153	852-05616	ASPMC5/BL	176
851-10272	RJ45C5E-2.0M/RD	159	851-15306	RJ45NGB-5.0M/GREEN	153	852-05617	ASPMC5/GN	176
851-10279	RJ45C5E-2.0M/YL	160	851-15310	RJ45NGB-5.0M/RD	154	852-05618	ASPMC5/RD	176
851-10281	RJ45C5E-2.0M-LSOH/YL	157	851-15312	RJ45NGB-5.0M/YL	155	852-10010	MB08IDCC5E/WH	121
851-10301	RJ45C5E-3.0M/BL	158	851-15404	RJ45NGB-10.0M/YL	155	852-25016	RJ45FC3-BLK	126
851-10303	RJ45C5E-3.0M/GN	158	851-15682	RJ45NGB-1.0M/GY ID	194	852-25017	RJ45FC3-BLU	126
851-10304	RJ45C5E-3.0M/GY	159	851-15683	RJ45NGB-2.0M/GY ID	194	852-25018	RJ45FC3-BRN	126
851-10306	RJ45C5E-3.0M/RD	159	851-15684	RJ45NGB-3.0M/GY ID	194	852-25020	RJ45FC3-FW	126
851-10309	RJ45C5E-3.0M/YL	160	851-15686	RJ45NGB-5.0M/GY ID	194	852-25021	RJ45FC3-GRN	126
851-10310	RJ45C5E-3.0M-LSOH/GY	156	851-15823	RJ45NGB-1.0M/GY	154	852-25022	RJ45FC3-GRY	126
851-10311	RJ45C5E-3.0M-LSOH/RD	157	851-15970	RJ45NGB-10.0M/GY ID	194	852-25023	RJ45FC3-I	126
851-10312	RJ45C5E-3.0M-LSOH/YL	157	851-15981	RJ45NGB-10.0M/GN	153	852-25024	RJ45FC3-ORN	126
851-10334	RJ45C5E-5.0M/BL	158	851-15983	RJ45NGB-10.0M/GY	154	852-25025	RJ45FC3-RED	126
851-10337	RJ45C5E-5.0M/GN	158	851-30000	RJ45C6AGY-1.0M	152	852-25026	RJ45FC3-VIO	126
851-10338	RJ45C5E-5.0M/GY	159	851-30001	RJ45C6AGY-2.0M	152	852-25027	RJ45FC3-W	126
851-10340	RJ45C5E-5.0M/RD	159	851-30002	RJ45C6AGY-3.0M	152	852-25028	RJ45FC3-YEL	126
851-10343	RJ45C5E-5.0M/YL	160	851-30004	RJ45C6AGY-5.0M	152	852-25036	RJ45FC5E-BLK	122
851-10378	RJ45C5E-5.0M/LSOH/YL	157	851-30005	RJ45C6AGY-10.0M	152	852-25037	RJ45FC5E-BLU	122
851-10611	RJ45C5E-5.0M-LSOH/GY	156	851-40196	RN BLANK	66	852-25040	RJ45FC5E-BRN	122
851-10682	RJ45C5E-1.0M-LSOH/GY	156	852-05184	AS08IDCNGB/BK	102	852-25044	RJ45FC5E-FW	122
851-10685	RJ45C5E-2.0M-LSOH/GY	156	852-05185	AS08IDCNGB/WH	101	852-25045	RJ45FC5E-GRN	122
851-10698	RJ45C5E-2.0M-LSOH/BL	155	852-05186	AS08IDCNGBSLD/BK	110	852-25046	RJ45FC5E-GRY	122
851-10699	RJ45C5E-3.0M-LSOH/BL	155	852-05187	AS08IDCNGBSLD/WH	109	852-25047	RJ45FC5E-I	122
851-10700	RJ45C5E-2.0M-LSOH/RD	157	852-05197	AS08J-J-C5E/WH	116	852-25048	RJ45FC5E-ORN	122
851-10748	RJ45C5E-1.0MLS/RD	157	852-05237	AS08KBC5E/WH	112	852-25049	RJ45FC5E-RED	122
851-10749	RJ45C5E-1.0MLS/GN	156	852-05267	AS08KBLPC5E/WH	117	852-25059	RJ45FC5E-VIO	122
851-10751	RJ45C5E-2.0MLS/GN	156	852-05275	AS08PBC5ESLD/WH	123	852-25060	RJ45FC5E-W	122
851-10773	RJ45C5E-5.0MLS/RD	157	852-05303	ASFP03-3LC5E/WH	118	852-25061	RJ45FC5E-YEL	122
851-10774	RJ45C5E-10.0MLS/RD	157	852-05305	ASFP03-3L-NGB/WH	105	852-25064	RJ45FC6-BLK	108
851-10775	RJ45C5E-5.0MLS/BL	155	852-05326	ASPMC6/WH	176	852-25065	RJ45FC6-BLU	108
851-10776	RJ45C5E-10.0MLSBL	155	852-05380	EC08IDCNGB/BK	103	852-25067	RJ45FC6-BRN	108
851-10777	RJ45C5E-10.0MLS/GY	156	852-05381	EC08IDCNGB/WH	103	852-25069	RJ45FC6-FW	108
851-10778	RJ45C5E-3.0MLS/GN	156	852-05382	EC08IDCNGBSLD/WH	111	852-25070	RJ45FC6-GRN	108
851-10779	RJ45C5E-5.0MLS/GN	156	852-05386	EC08KBC5E/WH	114	852-25071	RJ45FC6-GRY	108
851-10780	RJ45C5E-10.0MLS/GN	156	852-05506	AS08IDCNGB/BL	102	852-25072	RJ45FC6-I	108
851-10781	RJ45C5E-1.0MLS/YL	157	852-05575	KS ASPMC5E/WH	178	852-25073	RJ45FC6-ORN	108
851-10783	RJ45C5E-10.0MLS/YL	157	852-05576	KS ASPMC6/WH	178	852-25074	RJ45FC6-RED	108
851-10788	RJ45C5E-1.0M LSOH/GY ID	194	852-05577	AS08IDCNGB/RD	102	852-25080	RJ45FC6-VIO	108

Article-No. 852-25081 – 855-40074

Article-No.	Type	Page	Article-No.	Type	Page	Article-No.	Type	Page
852-25081	RJ45FC6-W	108	854-05028	1CTV-P/BK	182	855-10054	FBASMBL-SCSCDX-FL001	130
852-25082	RJ45FC6-YEL	108	854-05041	2CTV-P/BK	182	855-10055	FBAMMBG-SCSCDX-FL001	130
852-30005	6C050	175	854-05113	CM2000G	182	855-14222	FBCSMBL-SCXXDX-3.0MX	134
852-30019	6C08IDCNGB-MSK/WH	104	854-05114	CM2000HD	182	855-15036	RNAFXCL-LCCPUS	191
852-30037	6C-ANG-C6/WH	107	854-05151	RS103 (100)	184	855-15037	RNAFXCL-SCCPUS	191
852-30039	6C-ANG-C5E/WH	120	854-15035	AS08/12ESFB	186	855-15038	RNAFXCL-MTCPUS	190
852-30047	6C-ANG-PMO/WH	178	854-20024	RNAORC1	181	855-20030	FBAMMBG-SCSCSX-FL001	131
852-30053	6C08IDCNGB-MSK/BK	104	854-20025	RNAORC2	180	855-20031	FBASMBL-SCSCSX-FL001	131
852-30054	6C08IDCC5E-MSK/WH	115	854-20026	RNAORC3	181	855-20041	FBAMMBG-LCLCQD-FL001	128
852-30055	6C08IDCC5E-MSK/BK	115	854-25015	WB-2U	185	855-20042	FBASMBL-LCLCQD-FL001	128
852-35076	CP2/1DA/1AV Red	188	854-25020	WB-3U	184	855-20055	FBASMBL-LCLCQD-FL001	129
852-35077	CP2/1DA/1AV KIT Red	188	854-35101	ASFP02/WH	168	855-25009	FBTXOS1-LCXXSW-01.0M	136
852-35078	CP2/2DA Purple	187	854-35121	6C ADP	175	855-25017	FBTXOS1-SCXXSW-01.0M	136
852-35079	CP2/2DA KIT Purple	187	854-35172	AS025/WH	172	855-25028	FBTXOM3-SCXXSW-01.0M	136
852-35080	CP3/1DA/2DV Blue	187	854-35174	AS050/WH	172	855-25033	FBTXOM3-LCXXSW-01.0M	136
852-35081	CP3/1DA/2DV KIT Blue	187	854-35181	ASBB01-27MM/WH	179	855-30015	FLCXXS1-LCLCDY-02.0M	164
852-35082	CP3/3DV Amber	188	854-35183	ASBB01-37MM/WH	180	855-30093	FLCXXS1-SCSCDY-01.0M	165
852-35083	CP3/3DV KIT Amber	188	854-35187	ASBB02-37MM/WH	179	855-30094	FLCXXS1-SCSCDY-02.0M	165
852-35130	0408IDCG6/WH	106	854-35202	ASFP01/WH	168	855-30095	FLCXXS1-SCSCDY-03.0M	165
852-40000	KSJ08SC6A	100	854-35210	ASFP01F/WH	169	855-30096	FLCXXS1-SCSCDY-05.0M	165
852-40002	KSJ08SC6A-12	100	854-35224	ASFP02F/WH	169	855-30148	FLCXXM3-SCSCDA-01.0M	164
853-00004	1/2508VIDC4PR/BK	98	854-35228	ASFPANG/WH	177	855-30156	FLCXXS1-LCLCDY-01.0M	164
853-00008	1/5008VIDC/BK	97	854-35309	ECO50/WH	173	855-30157	FLCXXS1-LCLCDY-05.0M	164
853-15036	RS103 (50)	184	854-35315	ECFP01/WH	170	855-30206	FLCXXM3-SCSCDA-03.0M	164
853-15047	PP110C5E481U	95	854-35321	ECFP02/WH	170	855-30272	FLCXXS1-LCLCDY-03.0M	164
853-20074	PP110C5E12V	96	854-35329	MBFP01/WH	171	855-30309	FLCXXM3-SCSCDA-02.0M	164
853-20075	PP110C5E24	94	854-35460	LL03U/WH/WH	185	855-30425	FLCXXM3-LCLCDA-01.0M	163
853-20078	PP110C5E48	93	854-35465	LL06U/WH/WH	186	855-30426	FLCXXM3-LCLCDA-02.0M	163
853-20110	1/2408-NMB-HD/BK	89	854-35481	MB025/WH	174	855-30427	FLCXXM3-LCLCDA-03.0M	163
853-20111	2/4808-NMB-HD/BK	88	854-35482	MB050/WH	174	855-30429	FLCXXM3-LCLCDA-05.0M	163
853-25000	0408IDCG5E/WH	119	854-35484	MBFP02/WH	171	855-30447	FLCXXM3-LCLCDA-10.0M	163
853-25017	1/2408IDCG5E/BK	87	854-35686	ASFP01 W ID	196	855-30448	FLCXXM3-SCSCDA-05.0M	164
853-25031	2/4808IDCG5E/BK	86	854-35690	ECFP01 W ID	196	855-30449	FLCXXM3-SCSCDA-10.0M	164
853-25034	2/4808IDCHDC5ECM/BK	83	854-35753	ECO25/WH	173	855-30450	FLCXXS1-LCLCDY-10.0M	164
853-25254	1/2408IDC G5E ID	195	854-39399	EC-ANG-PMO/WH	177	855-30451	FLCXXS1-SCSCDY-10.0M	165
853-25255	2/4808IDC G5E ID	195	854-40073	PIPT	189	855-30909	FLCXXS2-LCLCDY-01.0M	164
853-30034	1U 24P J/J A/S HD C5E PANEL BK	85	854-40074	RS002	183	855-30910	FLCXXS2-LCLCDY-02.0M	164
853-30336	1/2408IDCHDC5ECM/BK	84	854-40077	RS100	183	855-30911	FLCXXS2-LCLCDY-03.0M	164
853-30339	1/4808IDC C5E/BK	90	854-40080	RS103	184	855-30912	FLCXXS2-LCLCDY-05.0M	164
853-35056	HT2408PB-U5E-M/BK	91	854-40177	DCMJST	190	855-30913	FLCXXS2-LCLCDY-10.0M	164
853-35090	NGM2408IDC-S5E/BK	92	854-40195	HT-KSJ08S-TT	189	855-30914	FLCXXS2-SCSCDY-01.0M	165
853-35094	1/4808IDC C6/BK	76	854-40266	RNAD-BLANK	66	855-30915	FLCXXS2-SCSCDY-02.0M	165
853-35104	NGM2408IDC-S6/BK	78	855-00218	FBPDBKL-SCMMDX-24VF1	146	855-30916	FLCXXS2-SCSCDY-03.0M	165
853-40075	1/2408IDCNGBHDCM/BK	73	855-00219	FBPDBKL-SCSMDX-24VF1	146	855-30917	FLCXXS2-SCSCDY-05.0M	165
853-40107	2/4808IDCNGBHDCM/BK	72	855-00221	FBPDBKL-LCMMDX-24VF1	145	855-30918	FLCXXS2-SCSCDY-10.0M	165
853-45004	1/2408IDC G6/BK	75	855-00222	FBPDBKL-LCSMDX-24VF1	145	855-30920	FLCXXM4-LCLCDA-01.0M	163
853-45009	2/4808IDCG6/BK	74, 195	855-00266	FBPDBKL-LCMMQD-24VF1	145	855-30921	FLCXXM4-LCLCDA-02.0M	163
853-45032	1/2408IDC G6 ID	195	855-00268	FBPDBKL-LCSMQD-24VF1	145	855-30922	FLCXXM4-LCLCDA-03.0M	163
853-50001	PP110C612V	82	855-10011	FBCMMBG-LCXXSX-0.9WH	133	855-30923	FLCXXM4-LCLCDA-05.0M	163
853-50002	PP110C624	80	855-10012	FBCSMBL-LCXXSX-0.9WH	133	855-30924	FLCXXM4-LCLCDA-10.0M	163
853-50003	PP110C648	79	855-10026	FBCMMBG-LCXXSX-3.0WH	133	855-30925	FLCXXM4-SCSCDA-01.0M	164
853-50011	PP110C6481U	81	855-10029	FBCMMBG-SCXXSX-3.0WH	135	855-30926	FLCXXM4-SCSCDA-02.0M	164
853-50021	HT2408PB-UC6-M/BK	77	855-10032	FBCMMBG-SCXXSX-0.9WH	135	855-30927	FLCXXM4-SCSCDA-03.0M	164
853-55000	PP24G6A-PA1URS-FD.XX	70	855-10041	FBCMMBG-LCXXDX-3.0WH	132	855-30928	FLCXXM4-SCSCDA-05.0M	164
853-55001	PP24G6A-PA1URS-SL.XX	71	855-10045	FBCSMBL-SCXXSX-0.9WH	135	855-30929	FLCXXM4-SCSCDA-10.0M	164
854-00000	1/CC-IDHW1	97	855-10046	FBCSMBL-SCXXSX-3.0WH	135	855-40069	HT-OM3-4-LT	161
854-00001	1/2408-C6-IDHW1	97	855-10049	FBAMMBG-LCLCQD-FL001	129	855-40070	HT-OM3-8-LT	161
854-00007	1/BM-0608-IDHW1	98	855-10051	FBCMMBG-SCXXDX-3.0MX	134	855-40071	HT-OM3-12-LT	161
854-00008	CBM-0208-IDHW1	98	855-10052	FBCSMBL-LCXXSX-3.0WH	133	855-40073	HT-OM3-24-LT	161
854-05009	1CTLB-R/BK1	83	855-10053	FBCSMBL-LCXXDX-3.0WH	132	855-40074	HT-OS1-4-LT	161

Article-No. 855-40075 – 860-00169

Article-No.	Type	Page	Article-No.	Type	Page	Article-No.	Type	Page
855-40075	HT-OS1-8-LT	161	859-21660	RNFTD-24LCSFS1-10.0M	54	859-51097	RN06G6A-CABEXX-10.0M	17
855-40076	HT-OS1-12-LT	161	859-21661	RNFTD-24LCSFM3-10.0M	54	860-00000	RNFT672-MCMMC4-10.0M	47
855-40078	HT-OS1-24-LT	161	859-21662	RNFTD-24LCSFM4-10.0M	54	860-00008	FLX24M4-MFMFXA-10.0M	142
855-40089	HT-OM3-4-TB	162	859-21663	RNFTD-12LCMMMS1-XX.XX	56	860-00011	FLX24M3-MFMFXA-10.0M	142
855-40090	HT-OM3-8-TB	162	859-21664	RNFTD-12LCMMM3-XX.XX	56	860-00014	FLS24S1-MFMFXA-10.0M	143
855-40091	HT-OM3-12-TB	162	859-21665	RNFTD-12LCMMM4-XX.XX	56	860-00017	FLS12M4-MFMFXA-10.0M	143
855-40093	HT-OM3-24-TB	162	859-21666	RNFTD-24LCMMMS1-XX.XX	51	860-00020	FLS12M3-MFMFXA-10.0M	144
855-40094	HT-OS1-4-TB	163	859-21667	RNFTD-24LCMMM3-XX.XX	51	860-00023	FLS12S1-MFMFXA-10.0M	144
855-40095	HT-OS1-8-TB	163	859-21668	RNFTD-24LCMMM4-XX.XX	51	860-00028	FLS12M4-MFLFDA-10.0M	138
855-40096	HT-OS1-12-TB	163	859-21669	RNFTD-12SCSCM4-10.0M	59	860-00030	FLS12M3-MFLFDA-10.0M	139
855-40098	HT-OS1-24-TB	163	859-21670	RNFTD-12SCSFS1-10.0M	61	860-00034	FLS24M4-MFLFDA-10.0M	137
855-40111	HT-OM4-12-LT	160	859-21671	RNFTD-12SCSFM4-10.0M	61	860-00036	FLS24M3-MFLFDA-10.0M	137
855-40112	HT-OM4-24-LT	160	859-21672	RNFTD-12SCMMS1-XX.XX	60	860-00043	FLS12S1-MFLFDA-10.0M	139
855-40113	HT-OM4-12-TB	162	859-21673	RNFTD-12SCMMM3-XX.XX	60	860-00045	FLS24S1-MFLFDA-10.0M	138
855-40114	HT-OM4-24-TB	162	859-21674	RNFTD-12SCMMM4-XX.XX	60	860-00047	RNFT672-MCMCS1-10.0M	47
859-00199	RN06U5E-CAPOXX-10.0M	36	859-21679	RNFTD-24LC1MS1-XX.XX	52	860-00106	RNFT672-MCMMC3-10.0M	47
859-00260	RN06UC6-CAPOXX-10M	26	859-21680	RNFTD-24LC1MM3-XX.XX	52	860-00152	RNFT6H4-MCMCS1-10.0M	43
859-00318	RN04U5E-CAPOXX-10.0M	41	859-21681	RNFTD-24LC1MM4-XX.XX	52	860-00153	RNFT6H4-MCMMC3-10.0M	43
859-00352	RN12UC6-CASPO2-10.0M	21	859-21735	RNFTD12-SFSFM3-10.0M	141	860-00154	RNFT6H4-MCMMC4-10.0M	43
859-05415	RN04UC6-CACAXX-10.0M	28	859-21736	RNFTD48-SFSFM3-10.0M	141	860-00155	RNFTVH4-MCMCS1-10.0M	44
859-05417	RN04U5E-CACAXX-10.0M	38	859-21737	RNFTD96-SFSFM3-10.0M	141	860-00156	RNFTVH4-MCMMC3-10.0M	44
859-05490	RN06U5E-CACAXX-10.0M	33	859-21738	RNFTDH4-SFSFM3-10.0M	141	860-00157	RNFTVH4-MCMMC4-10.0M	44
859-05628	RN06UC6-CACAXX-10.0M	23	859-21739	RNFTD12-SFSFS1-10.0M	141	860-00158	RNFT672-MCMLS1-10.0M	48
859-06004	RN12UC6-CACAXX-10.0M	18	859-21740	RNFTD48-SFSFS1-10.0M	141	860-00159	RNFT672-MCMLM3-10.0M	48
859-06005	RN12UC6-CASC02-10.0M	20	859-21741	RNFTD96-SFSFS1-10.0M	141	860-00160	RNFT672-MCMLM4-10.0M	48
859-10001	RNCC5	65	859-21742	RNFTDH4-SFSFS1-10.0M	141	860-00161	RNFT6H4-MCMLS1-10.0M	45
859-10285	RN04UC6-CABEXX-10.0M	32	859-30013	RN04-2408-UJL	63	860-00162	RNFT6H4-MCMLM3-10.0M	45
859-10291	RN06UC6-CABEXX-10.0M	27	859-30019	RNA6UXX-PA1URS-XX.XX	62	860-00163	RNFT6H4-MCMLM4-10.0M	45
859-10330	RN06U5E-CABEXX-10.0M	37	859-30022	RNA6UXX-PA1UCN-XX.XX	62	860-00164	RNFTVH4-MCMLS1-10.0M	46
859-10839	RN04U5E-CABEXX-10.0M	42	859-30033	RNADUXX-PA1URS-XX.XX	62	860-00165	RNFTVH4-MCMLM3-10.0M	46
859-20622	RNFTD12-LCLCM3-10.0M	55	859-30042	RNAHUXX-PA1URS-HH.SS	64	860-00166	RNFTVH4-MCMLM4-10.0M	46
859-20624	RNFTD24-LCLCM3-10.0M	50	859-30043	RNAHUXX-PA1URS-HS.HS	64	860-00167	RNFT672-MCLFS1-10.0M	49
859-20639	RNFTD12SCSFS1-10.0M	59	859-30045	RNADUXX-PA1UCN-XX.XX	62	860-00168	RNFT672-MCLFM3-10.0M	49
859-20799	RNFTD12-LCLFM3-10.0M	57	859-30047	RNA6UXX-PB1URS-XX.XX	64	860-00169	RNFT672-MCLFM4-10.0M	49
859-20805	RNFTD24-LCLFM3-10.0M	53	859-30048	RNA6UXX-PB1UCN-XX.XX	64			
859-20832	RNFTD12-LCLFS1-10.0M	55	859-30049	RNAHUXX-PA1UCN-HH.SS	64			
859-20875	RNFTD24-LCLCS1-10.0M	50	859-30050	RNAHUXX-PA1UCN-HS.HS	64			
859-20917	RNFTD12SCSCM3-10.0M	59	859-35000	RNCC6	65			
859-21024	RNFTD12-LFLFM3-10.0M	140	859-35001	RNCCC	65			
859-21253	RNFTD12SCSFM3-10.0M	61	859-35007	RN-MESH Kit	67			
859-21254	RNFTD24-LCLFS1-10.0M	53	859-35027	TRO01-V2	67			
859-21255	RNFTD12-LCLFS1-10.0M	57	859-35050	RNSFB-1	66			
859-21266	RNFTD24-LFLFM3-10.0M	140	859-35064	RNSFB-3	66			
859-21267	RNFTD48-LFLFM3-10.0M	140	859-35134	RN04-BLANK	66			
859-21269	RNFTD96-LFLFM3-10.0M	140	859-35339	RN04UC6-CAPOXX-10.0M	31			
859-21270	RNFTDH4-LFLFM3-10.0M	140	859-35448	RN06UC6-CAKJXX-10.0M	24			
859-21279	RNFTS24-SFSFM3-10.0M	141	859-35541	RN06G6A-CAKJXX-10.0M	15			
859-21302	RNFTD12-LFLFS1-10.0M	140	859-35546	RN06U5E-CAKJXX-10.0M	34			
859-21303	RNFTD24-LFLFS1-10.0M	140	859-35578	RN12UC6-CABEXX-10.0M	22			
859-21304	RNFTD48-LFLFS1-10.0M	140	859-35950	RN04UC6-CAKJXX-10.0M	29			
859-21306	RNFTD96-LFLFS1-10.0M	140	859-36882	RN06G6A-CAPLXX-10.0M	16			
859-21307	RNFTDH4-LFLFS1-10.0M	140	859-37952	RN04U5E-CAKJXX-10.0M	39			
859-21315	RNFTS24-SFSFS1-10.0M	141	859-40084	RN04UC6-CAPLXX-10.0M	30			
859-21653	RNFTD12-LCLCM4-10.0M	55	859-40137	RN06U5E-CAPLXX-10.0M	35			
859-21654	RNFTD24-LCLCM4-10.0M	50	859-40307	RN06UC6-CAPLXX-10.0M	25			
859-21655	RNFTD12-LCLFM4-10.0M	57	859-40325	RN12UC6-CAPLXX-10.0M	19			
859-21656	RNFTD24-LCLFM4-10.0M	53	859-40872	RN04U5E-CAPLXX-10.0M	40			
859-21657	RNFTD12-LCSFS1-10.0M	58	859-50019	RN06G6A-CACAXX-10.0M	14			
859-21658	RNFTD12-LCSFM3-10.0M	58	859-50851	RNA6G6A-PA1URS-XX.XX	63			
859-21659	RNFTD12-LCSFM4-10.0M	58	859-50852	RNA6G6A-PA1UCN-XX.XX	63			

1. Interpretation

1.1 In these Conditions:

"**ACKNOWLEDGEMENT OF ORDER**" shall mean the document by which the Seller's authorised representative accepts the Order.

"**BUYER**" shall mean the purchaser of the Goods from the Seller.

"**CONDITIONS**" means the terms and conditions of sale set out herein and includes any special terms and conditions included in the Acknowledgement of Order.

"**CONTRACT**" shall mean the contract for the sale and purchase of the Goods made pursuant to these Conditions.

"**GOODS**" shall mean the goods which the Seller has agreed to supply to the Buyer pursuant to these Conditions.

"**LOSS**" shall mean all actions, claims, demands, losses (direct, indirect, consequential or otherwise), expenses, costs, actions and proceedings.

"**ORDER**" shall mean the Buyer's order for Goods.

"**SELLER**" shall mean HellermannTyton Data Ltd., a company registered in England and Wales under company number 2412201.

"**SPECIFICATION**" shall mean the description of the Goods set out in the Acknowledgement of Order.

1.2 Any reference in these Conditions to any provision of a statute shall be construed as a reference to that provision as amended, re-enacted or extended at the relevant time.

1.3 The headings in these Conditions are for convenience only and shall not affect their interpretation.

2. Basis of Sale

2.1 These Conditions shall be incorporated into each Contract and shall prevail and be effective notwithstanding any variations or additions whether contained or referred to in the Order, or other document submitted by the Buyer or in correspondence or elsewhere, or implied by trade, custom, practice or course of dealing, and shall supersede all other and any prior promises, representations or undertakings.

2.2 No variation to these Conditions shall be binding unless agreed in writing by an authorised representative of the Seller.

3. Orders and Specifications

3.1 Each Order shall be deemed to be an offer by the Buyer to purchase Goods subject to these Conditions.

3.2 No Order submitted by the Buyer shall be deemed to be accepted by the Seller unless and until confirmed by an Acknowledgement of Order.

3.3 The Buyer shall be responsible to the Seller for ensuring the accuracy of the terms of any Order (including any applicable specification) submitted by the Buyer and for giving the Seller any necessary information relating to the Goods within a sufficient time to enable the Seller to perform the Contract in accordance with its terms.

3.4 If the Goods are to be manufactured by the Seller in accordance with a specification or instructions submitted by the Buyer:

3.4.1 the Buyer shall indemnify the Seller against all Loss suffered by the Seller in connection with any claim by a third party that the manufacture and/or supply of the Goods to such specification or instructions infringes the rights of any third party; and

3.4.2 the Buyer shall be responsible for supplying reliable and accurate information to the Seller (including, without limitation, drawings, plans and designs) to enable the Seller to manufacture the Goods.

3.5 The Seller reserves the right to make any changes in the Specification of the Goods which are required to conform with any applicable UK safety or other statutory requirements and/or where such changes do not materially affect the quality or performance of the Goods

3.6 No Order which has been accepted by the Seller may be cancelled by the Buyer except with the agreement in writing of the Seller and on terms that the Buyer shall indemnify the Seller in full against all Loss incurred by the Seller as a result of cancellation.

4. Price of the Goods

4.1 Any Price quoted or accepted is exclusive of VAT (which will, where applicable, be charged at the current rate) and of any other duties and taxes which may be payable in respect of the Goods which will be paid by the Buyer. The price shall be the price quoted in the Acknowledgement of Order. The Seller reserves the right by giving notice to the Buyer at any time before delivery to increase the price to reflect any increase in the cost to the Seller which is due to any factor beyond the control of the Seller (such as without limitation any foreign exchange fluctuation, currency regulation, alteration of duties, significant increase in the costs of labour materials, or other costs of manufacture), any change in delivery dates, quantities or specifications for the Goods which is requested by the Buyer or any delay caused by any instructions of the Buyer or failure of the Buyer to give the Seller adequate information or instructions.

4.2 Except as otherwise stated in an Acknowledgement of Order all prices are given by the Seller for delivery as defined in clause 6.1. Where the Seller agrees to deliver the Goods otherwise than as defined in clause 6.1 the Buyer shall be liable to pay the Seller's charges for transport packaging and insurance where requested.

5. Terms of Payment

5.1 Subject to any special terms agreed in writing between the Buyer and the Seller, the Seller shall be entitled to invoice the Buyer for the price of the Goods on or at any time after delivery of the Goods. If the Goods are to be collected by the Buyer or the Buyer wrongfully fails to take delivery of the Goods, the Seller shall be entitled to invoice the Buyer for the price at any time after the Seller has notified the Buyer that the Goods are ready for collection or (as the case may be) the Seller has tendered delivery of the Goods.

5.2 The Buyer shall pay the price without deduction within 30 days of the date of the Seller's invoice notwithstanding that delivery may not have taken place and the property in the Goods has not passed to the Buyer. The time of payment of the price shall be of the essence of the Contract. Receipts for payment will be issued only upon request.

5.3 If the Buyer fails to make any payment in accordance with clause 5.2 then without prejudice to any other right or remedy available to the Seller the Seller shall be entitled to:-

5.3.1 cancel the Contract or suspend any further deliveries to the Buyer;

5.3.2 appropriate any payment made by the Buyer to such of the Goods (or the goods supplied under any other contract between the Buyer and the Seller) as the Seller may think fit (notwithstanding any purported appropriation by the Buyer);

5.3.3 charge the Buyer interest on the amount unpaid at the rate of 3 percent per annum above Royal Bank of Scotland Bank base rate from time to time until payment in full is made (a part of

a month being treated as a full month for the purpose of calculating interest); and

5.4 Except where insolvency laws provide otherwise the Buyer shall not be entitled to withhold or set off payment for Goods for any reason whatsoever. All Goods for which payment has not been made in accordance with clause 5.2 and which are held by the Seller at its premises are so held at the Buyer's risk.

6. Delivery

6.1 Except as otherwise stated in an Acknowledgement of Order delivery shall take place when the Seller places the Goods at the disposal of the Buyer at the Seller's premises

6.2 Any delivery date is approximate only. The Seller shall not be liable for any Loss arising from failure to deliver the Goods on the delivery date howsoever caused. Time for delivery shall not be of the essence unless previously agreed by the Seller in writing. The Goods may be delivered by the Seller in advance of the quoted delivery date upon giving reasonable notice to the Buyer.

6.3 Where the Goods are to be delivered in instalments each delivery shall constitute a separate contract and failure by the Seller to deliver any one or more of the instalments in accordance with these Conditions or any claim by the Buyer in respect of any one or more instalments shall not entitle the Buyer to treat the Contract as a whole as repudiated.

6.4 If the Seller fails to deliver the Goods for any reason other than any cause beyond the Seller's reasonable control or the Buyer's fault and the Seller is accordingly liable to the Buyer the Seller's only liability shall be limited to the excess (if any) of the cost to the Buyer (in the cheapest available market) of purchasing similar goods to replace those not delivered.

6.5 If the Buyer fails to take delivery on the delivery date then without prejudice to any other right or remedy available to the Seller the Seller may:

6.5.1 store the Goods until actual delivery and charge the Buyer for the costs (including insurance) of storage; or

6.5.2 treat the Contract as repudiated by the Buyer and without prejudice to any other right it may have against the Buyer the Seller shall be entitled to resell the Goods and be indemnified by the Buyer for any Loss which it suffers.

7. Risk and Property

7.1 Risk of damage to or loss of the Goods shall pass to the Buyer on delivery of the Goods;

7.2 Notwithstanding delivery and the passing of risk in the Goods or any other provision of these Conditions the property in the Goods shall remain with the Seller until the Seller has received in cash or cleared funds payment in full of the price and any other monies due to the Seller in respect of the Goods and all other goods agreed to be sold by the Seller to the Buyer for which payment is then due under the Contract or any other contract between the Seller and the Buyer (including without limitation costs of delivery).

7.3 Until such time as the property in the Goods passes to the Buyer the Buyer shall hold the goods as the Seller's fiduciary agent and bailee and shall keep the Goods separate from those of the Buyer and third parties and properly stored protected and insured and identified as the Seller's property.

7.4 Until such time as the property in the Goods passes to the Buyer the Buyer shall be entitled to resell or use the Goods in the ordinary course of its business but shall account to the Seller for the proceeds of sale or otherwise of the Goods whether

tangible or intangible including insurance proceeds and shall keep all such proceeds separate from any monies or property of the Buyer and third parties and in the case of tangible proceeds properly stored protected and insured.

7.5 If the Goods are prior to sale by the Buyer made up or incorporated in or mixed with other goods, then if they remain separately identifiable the Seller shall retain property and title thereof and if they do not remain separately identifiable the Seller shall become a joint owner of the goods in or which the Goods are incorporated or mixed in such proportion as the value of the Goods bears to the value of the Goods in which the Goods are so incorporated or mixed.

7.6 If the Buyer sells the Goods or the goods in which the Goods have been incorporated or mixed the sale shall be on behalf of the Seller as the joint owner thereof as the case may be and the proceeds of any such sale for the Seller's share thereof if the sale is of jointly owned property shall be held on trust for the Seller and in a separate identified account.

7.7 Until such time as the property in the Goods passes to the Buyer (and provided the Goods are still in existence and have not been resold) the Seller shall be entitled at any time to require the Buyer to deliver up the Goods to the Seller and if the Buyer fails to do so forthwith to enter the premises of the Buyer or any third party where the Goods are stored and take possession of any Goods in which property remains in the Seller and remove and dispose of them as the Seller thinks fit. The Seller shall apply the proceeds of disposal (after deduction of all expenses) in discharge of the amount unpaid by the Buyer.

7.8 The Buyer shall not be entitled to pledge or in any way charge by way of security for any indebtedness any of the Goods which remain the property of the Seller without the Seller's consent but if the Buyer does so all moneys owing by the Buyer to the Seller shall (without prejudice to any other right or remedy of the Seller) forthwith become due and payable.

8. Confidentiality and Proprietary Rights

8.1 The Buyer agrees and undertakes that it will keep confidential and will not disclose or use for any purpose (other than to perform its obligations under the Contract) any confidential information. Any confidential information supplied to the Buyer by the Seller shall at all times remain the property of the Seller. The Buyer shall not acquire any rights in the confidential information, which shall be returned to the Seller immediately upon request.

8.2 Unless otherwise agreed in writing all intellectual property rights in relation to the Goods including without limitation their method of manufacture shall vest in the Seller and remain the property of the Seller notwithstanding the purchase of the Goods by the Buyer and the Buyer undertakes to do all acts and/or enter into such agreements or deeds as the Seller shall require to vest any such intellectual property rights in the Seller.

8.3 Unless otherwise agreed in writing and notwithstanding that the Buyer may have contributed towards the costs of such items all tooling (and all intellectual property rights in relation to such tooling) produced or acquired by the Seller in relation to the manufacture of the Goods shall be and remain the property of the Seller.

9. Warranty

9.1 The Seller warrants that upon delivery the Goods accord with the Specification and are free from defects in material and workmanship developing

out of normal use for a period of one year from the date of delivery.

9.2 The Seller shall not be liable for any breach of warranty unless:

(a) the Buyer gives written notice of the defect to the Seller and (if the defect is as a result of damage in transit) to the carrier, within 7 days of the time when the Buyer discovers or ought to have discovered the defect; and
(b) the Seller is given a reasonable opportunity after receiving the notice of examining such Goods and the Buyer (if asked to do so by the Seller) returns such Goods to the Seller's place of business at the Seller's cost for examination.

9.3 The Seller shall not be liable for a breach of warranty if:

(a) the Buyer makes any further use of such Goods after giving such notice; or
(b) the defect arises because the Buyer failed to follow the Seller's oral or written instructions as to the storage, installation, commissioning, use or maintenance of the Goods or (if there are none) good trade practice; or
(c) the Buyer alters or repairs such Goods without the written consent of the Seller.

9.4 Subject to conditions 9.2 and 9.3 if any of the Goods do not conform with the warranty in condition 9.1 the Seller shall at its option repair or replace such Goods (or the defective part) or refund the price of such Goods at the pro rata Contract rate provided that, if the Seller so requests, the Buyer shall, at the Seller's expense, return the Goods or the part of such Goods which is defective to the Seller.

9.5 The Seller complies with condition 9.4 it shall have no further liability whatsoever for warranty claims.

10. Limitation of liability

10.1 Subject to clause 9, the following provisions set out the entire financial liability of the Seller (including any liability for the acts or omissions of its employees, agents and sub-contractors) to the Buyer in respect of:

(a) any breach of these Conditions; and
(b) any representation, statement or tortious act or omission including negligence arising under or in connection with the Contract.

10.2 All warranties, conditions and other terms implied by statute or common law (save for the conditions implied by section 12 of the Sale of Goods Act 1979) are, to the fullest extent permitted by law, excluded from the Contract.

10.3 Nothing in these Conditions excludes or limits the liability of the Seller for death or personal injury caused by the Seller's negligence or fraudulent misrepresentation.

10.4 Subject to clauses 10.2 and 10.3:

(a) the Seller's total liability in contract, tort (including negligence or breach of statutory duty), misrepresentation, restitution or otherwise, arising in connection with the performance or contemplated performance of this Contract shall be limited to all sums paid under the Contract; and
(b) the Seller shall not be liable to the Buyer for any indirect or consequential loss or damage (whether for loss of profit, loss of business, depletion of goodwill or otherwise), costs, expenses or other claims for consequential compensation whatsoever (howsoever caused) which arise out of or in connection with the Contract.

11. Insolvency of Buyer

11.1 In the event that:

11.1.1 the Buyer makes any voluntary arrangement with its creditors or becomes subject to an administration order or (being an individual or firm) becomes bankrupt or (being a company) goes into liquidation (otherwise than for the purposes of amalgamation or reconstruction);

11.1.2 an encumbrancer takes possession or a receiver or administrator is appointed of any of the property or assets of the Buyer;

11.1.3 the Buyer ceases or threatens to cease to carry on business;

11.1.4 the Seller reasonably apprehends that any of the events mentioned above is about to occur in relation to the Buyer and notifies the Buyer accordingly, then without prejudice to any other right or remedy available to the Seller the Seller shall be entitled to suspend further performance of the Contract for such time as it shall in its absolute discretion see fit or treat the Contract as wrongfully repudiated by the Buyer and forthwith terminate the Contract (either with or without notice to the Buyer) without any liability to the Buyer and if the Goods have been delivered but not paid for the price shall become immediately due and payable notwithstanding any previous agreement or arrangement to the contrary.

12. Force Majeure

The Seller shall be excused from the performance of any of its obligations if and in so far as, and for so long as, such performance is delayed or prevented by circumstances beyond its reasonable control including but not limited to strikes, lock-outs or labour disputes of any kind (whether relating to its own employees or others), fire, flood, explosion, natural catastrophe, terrorism, military operations, blockade, sabotage, revolution, riot, civil commotion, war or civil war.

13. Export Terms

The Buyer shall be responsible for complying with any legislation or regulations governing the importation of the Goods into the country of destination and for the payment of any duties thereon.

14. General

14.1 Any notice required or permitted to be given by either party to the other under these Conditions shall be given in writing at its registered office or principal place of business or such other address as may be notified for such purpose to the party giving notice.

14.2 No waiver by the Seller of any breach of these Conditions shall be considered as a waiver of any subsequent breach of the same or any other provision.

14.3 If any provision of these Conditions is held by any competent authority to be invalid or unenforceable in whole or in part the validity of the other provisions of these Conditions and the remainder of the provision in question shall not be affected thereby.

14.4 A party who is not a party to the Contract shall have no right under the Contracts (Rights of Third Parties) Act 1999 to enforce any of its terms.

14.5 The Conditions shall be governed by the laws of England and each party submits to the non-exclusive jurisdiction of the English Courts.

14.6 These Conditions are binding on the Seller and its successors and assignees and the Buyer and its successors and permitted assignees.

System Compatibility Chart

Data Modules	Faceplates/Mounting Hardware
Category 6A FTP Installations	
Deca ¹⁰ Category 6A Keystone Jack	Flat Megaband 50mm x 50mm Faceplate/Mounting Hardware
Deca ¹⁰ Category 6A Angled Module	Flat Megaband 100mm x 50mm Faceplate/Mounting Hardware
Category 6 UTP Installations	
GigaBand (Alpha Snap) UTP Module	Bevelled 50mm x 50mm Faceplate/Mounting Hardware
Category 6 UTP Keystone Jack (Alpha Snap Module)	Bevelled 100mm x 50mm Faceplate/Mounting Hardware Flat 50mm x 50mm Faceplate/Mounting Hardware Flat 100mm x 50mm Faceplate/Mounting Hardware
Global Category 6 UTP Outlet Unshuttered	Not Required
Category 6 UTP 6C Installations	
Category 6 UTP 6C Module*	Floor Box
Category 6 UTP Angled 6C Module with Keystone Jack	6C Adaptor
* Adaptor available to use with Bevelled and Flat Faceplates	Bevelled 50mm x 50mm Faceplate/Mounting Hardware Bevelled 100mm x 50mm Faceplate/Mounting Hardware Flat 50mm x 50mm Faceplate/Mounting Hardware Flat 100mm x 50mm Faceplate/Mounting Hardware
Category 5e UTP Installations	
Alpha Snap Category 5e UTP Modules	Bevelled 50mm x 50mm Faceplate/Mounting Hardware
Alpha Snap Category 5e UTP Module Low Profile	Bevelled 100mm x 50mm Faceplate/Mounting Hardware
Category 5e UTP Keystone Jack (Alpha Snap Module)	Flat 50mm x 50mm Faceplate/Mounting Hardware
Triple Category 5e Module	Flat 100mm x 50mm Faceplate/Mounting Hardware
Global Category 5e UTP Faceplate Unshuttered	Not Required
Category 5e UTP Installations - MegaBand Range	
MegaBand Category 5e UTP Modules	MegaBand 50mm x 50mm Faceplate/Mounting Hardware MegaBand 100mm x 50mm Faceplate/Mounting Hardware
Category 5e UTP 6C Installations	
Category 5e UTP 6C Module*	Floor Box
Category 5e UTP Angled 6C Module with Keystone Jack	6C Adaptor
* Adaptor available to use with Bevelled and Flat Faceplates	Bevelled 50mm x 50mm Faceplate/Mounting Hardware Bevelled 100mm x 50mm Faceplate/Mounting Hardware Flat 50mm x 50mm Faceplate/Mounting Hardware Flat 100mm x 50mm Faceplate/Mounting Hardware
Category 6 Shielded Installations	
GigaBand Category 6 FTP Module	Bevelled 50mm x 50mm Faceplate/Mounting Hardware Bevelled 100mm x 50mm Faceplate/Mounting Hardware Flat 50mm x 50mm Faceplate/Mounting Hardware Flat 100mm x 50mm Faceplate/Mounting Hardware
Category 5e Shielded Installations	
Alpha Snap Category 5e FTP Module	Bevelled 50mm x 50mm Faceplate/Mounting Hardware Bevelled 100mm x 50mm Faceplate/Mounting Hardware Flat 50mm x 50mm Faceplate/Mounting Hardware Flat 100mm x 50mm Faceplate/Mounting Hardware

System Compatibility Chart

	Blanks	Cable	Patch Panel	Rear Cable Management
	¼ Blank ½ Blank	Category 6A UFTP LSOH	Deca ¹⁰ 24-port Category 6A UFTP 1U	Standard
	¼ Blank ½ Blank	Category 6 UTP PVC Category 6 UTP LSOH	GigaBand 24-port Category 6 UTP 1U GigaBand 48-port Category 6 UTP 2U Global 24-port Category 6 UTP 1U Global 48-port Category 6 UTP 2U	Standard Standard Optional Optional
	Not Required		EcoBand HD 48-port Category 6 UTP 1U	Standard
	6C ½ Blank ½ Blanks for Floor Box	Category 6 UTP PVC Category 6 UTP LSOH	GigaBand 24-port Category 6 UTP 1U GigaBand 48-port Category 6 UTP 2U Global 24-port Category 6 UTP 1U Global 48-port Category 6 UTP 2U EcoBand HD 48-port Category 6 UTP 1U	Standard Standard Optional Optional Standard
	¼ Blank ½ Blank	Category 5e UTP PVC Category 5e UTP LSOH	Alpha Snap 24-port Category 5e UTP 1U Alpha Snap 48-port Category 5e UTP 2U Global 24-port Category 5e UTP 1U Global 48-port Category 5e UTP 2U EcoBand 24-port Category 5e UTP 1U EcoBand 48-port Category 5e UTP 1U HD MegaBand 24-port Category 5e UTP 1U MegaBand 48-port Category 5e UTP 2U	Standard Standard Optional Optional Standard Standard Optional Optional
	Not Required	Category 5e UTP PVC Category 5e UTP LSOH	Alpha Snap 24-port Category 5e UTP 1U Alpha Snap 48-port Category 5e UTP 2U Global 24-port Category 5e UTP 1U Global 48-port Category 5e UTP 2U EcoBand 24-port Category 5e UTP 1U EcoBand 48-port Category 5e UTP 1U HD MegaBand 24-port Category 5e UTP 1U MegaBand 48-port Category 5e UTP 2U	Standard Standard Optional Optional Standard Standard Optional Optional
	¼ Blank ½ Blank	Category 5e UTP PVC Category 5e UTP LSOH	MegaBand 24-port Category 5e UTP 1U MegaBand 48-port Category 5e UTP 2U	Optional Optional
	6C ½ Blank ½ Blanks for Floor Box	Category 5e UTP PVC Category 5e UTP LSOH	Alpha Snap 24-port Category 5e UTP 1U Alpha Snap 48-port Category 5e UTP 2U Global 24-port Category 5e UTP 1U Global 48-port Category 5e UTP 2U EcoBand 24-port Category 5e UTP 1U EcoBand 48-port Category 5e UTP 1U HD MegaBand 24-port Category 5e UTP 1U MegaBand 48-port Category 5e UTP 2U	Standard Standard Optional Optional Standard Standard Optional Optional
	¼ Blank ½ Blank	Category 6 FTP PVC Category 6 FTP LSOH	EcoBand 24-port Category 6 FTP 1U	Standard Standard Standard
	¼ Blank ½ Blank	Category 5e FTP PVC Category 5e FTP LSOH	EcoBand 24-port Category 5e FTP 1U	Standard Standard Standard Standard

HellermannTyton Data Patch Panels - The Brands (Product Overview)

	Deca ¹⁰	GigaBand	Global	Alpha Snap	EcoBand High Density	EcoBand	MegaBand
Performance	Category 6A	Category 6	Category 6 & Category 5e	Category 5e	Category 6 & Category 5e	Category 5e	Category 5e
Individual PCB Modules	✓	✓	✗	✓	✗	✗	✗
Rear Cable Management included as standard	✓	✓	Optional	✓	✓	✓	Optional
Rack Snaps included as standard	✓	✓	✓	✓	✓	✓	✓
Sliding Labels	✗	✓	✗	✓	✗	Optional	✓
Magnifying Labelling lens	✓	✗	✓	✗	✗	✗	✗
High Density configuration (1U 48 port)	✗	✗	✗	✗	✓	✗	✗
Customisation (Joint branding with HellermannTyton)	Optional	Optional	Optional	Optional	Optional	Optional	Optional

Glossary of Terms

Category 6A – Cat 6A – Category 6A copper supports a 10G network and can deliver a 10G performance at 500 MHz. Standard compliant to TIA/EIA 568-B and ISO/IEC 11801.

Category 6 – Cat 6 – Category 6 copper can deliver 1 Gbps and above with transmission characteristics specified to 250MHz. Standard compliant to TIA/EIA 568-B and ISO/IEC 11801.

Category 5e – Cat 5e – Category 5e copper can deliver 1 Gbps and above with transmission characteristics specified to 100MHz. Standard compliant to TIA/EIA 568-B and ISO/IEC 11801.

Category 3 - Cat 3 (16 MHz - 100 Ohm UTP- To support applications up to 10 Mbps). Typically voice, ISDN, 4 Mbps Token Ring, and 10 Base-T. Maximum suggested allowed untwisting of pairs = 3".

Category 7
For cable and connecting hardware products with transmission characteristics specified to 600MHz. There are several different types of connectors that can be used with Category 7 - some are backwardly compatible with the RJ45 whilst others are not. This means that some Category 7 systems are not interoperable with others.

Category 7A
Refers to a new standard for cable and connecting hardware products specified to 1000MHz. Similar to Category 7, this relies on a fully shielded system with a different connector to the RJ45. This category is still in development so the full details need to be finalized.

UTP (Unshielded Twisted Pair)
Normal copper building cable, capable of high-speed data transmission. Techniques exist to address the signal impairments due to the transmission characteristics of copper media and to limit the radiated emission of UTP media.

(FTP) Foil Twisted Pair

A cable that use's a metallic Foil to surround the conductors in a twisted pair cable.

U/UTP Cable – Unshielded cable with unshielded twisted pair.

U/FTP Cable – Unshielded cable with shielded twisted pair.

F/UTP Cable – Shielded cable with unshielded twisted pair.

F/FTP Cable – Shielded cable with shielded twisted pair.

Crosstalk

Noise or interference caused by electromagnetic coupling from one signal path to another. Crosstalk performance is generally expressed in decibels.

IDC (Insulation Displacement Connector)

This is a blade style punch down you find on most Category connectors or the back block of a Category patch panels.

Decibel (dB)

A dB is a unit of measure of signal strength, usually the relation between a transmitted signal and a standard signal source. Every 3 dB = 50% of signal strength, so therefore a 6 dB loss = a loss of 75% of total signal strength.

Flood Wiring

The concept of wiring for future growth, by providing full coverage of information outlets. Usually installed on a regular grid i.e. 3-metres by 3-metres.

Consolidation Point

An interconnection point in horizontal cabling, typically used to support the rearrangement of furniture or partition walls. Generally used in open plan office environments.

Return Loss

A measure of the similarity of the impedance of a transmission line and the impedance

at its terminations. It is a ratio, expressed in decibels, of the power of the outgoing signal to the power of the signal reflected back.

Noise

The term used for spurious signals produced in a conductor by sources other than the transmitter to which it is connected. Noise can affect a legitimate signal to the extent that it is inaccurate or indecipherable when it reaches the receiver. The higher the speed of data transmission, the worse the effects of noise become.

MTP – Multiple Terminated Push-on – a pre-terminated cable with 12 or 24 fibres per MTP connector to ensure faster installation of multiple fibre links. The MTP connector has smaller diameter cables saving space in pathways and racks giving more space for air circulation.

Single Mode Fibre – OS1 and OS2

This has a small core for the light path, very focused, high quality signal. Usually requires a laser source to launch light into the cable and usually makes it mores expensive than LED sources used in Multimode fibre optic cable.

Multimode Fibre – OM3 and OM4

Optical fibres that have a large core and is mostly used for communication over a short distance. Easier to splice than single mode fibre but it supports more than one propagation mode and therefore higher pulse spreading rates. 62.5 micron is the common standard core size for premises cabling systems.

Standards**Classification**

Application classes for cabling have been identified for the purpose of the ISO/IEC 11801 standard;

Class A: cabling is characterised up to 100 kHz

Class B: cabling is characterised up to 1 MHz

Class C: cabling is characterised up to 16 MHz

Class D: cabling is characterised up to 100 MHz

Class E: cabling is characterised up to 250 MHz

Class EA: cabling is characterised up to 500 MHz

Class F: cabling is characterised up to 600 MHz

Class FA: cabling is characterised up to 1000 MHz

EIA/TIA

North American Standards Organisation.

EIA/TIA 568B

North American commercial building telecommunications wiring standard.

EIA/TIA 569A

North American commercial building standard for telecommunications pathways and spaces. It's purpose is to standardise specific design and construction practices within and between buildings which are in support of telecommunications media and equipment.

EIA/TIA 606

North American administration standard for the telecommunications infrastructure of commercial buildings. Its purpose is to provide guidelines for a uniform administration scheme for the cabling infrastructure.

EN 50173

The European standard for generic cabling for customer premises.

EN 50174

The European cabling systems planning & installation standard developed by CENELEC.



RapidNet

First Aid for Engineers

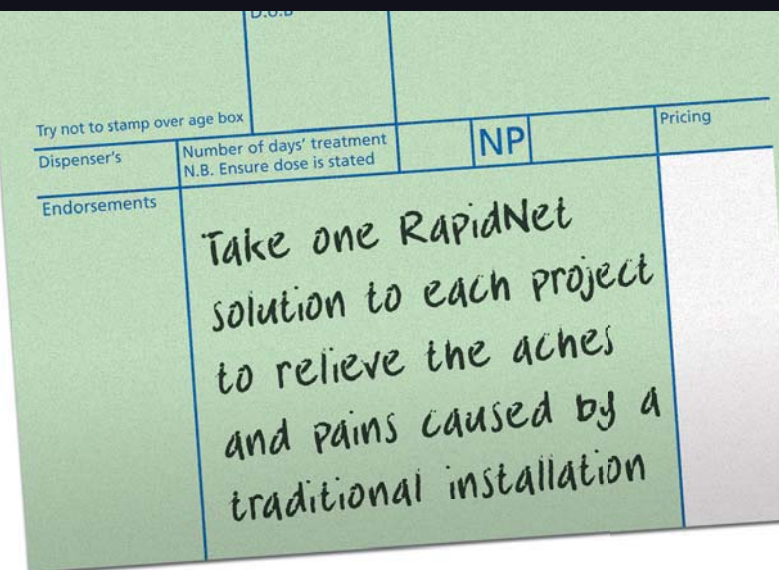

- + Reduce installation times by up to 75%
- + Fewer engineers per job
- + More time and men for additional installs
- + Increased margins
- + Faster turn-around for projects
- + Reduce expense claims on travel & overnight stays
- + No field terminations for copper or fibre
- + Plus all the features and benefits from the world leading pre-terminated, pre-tested solution



For further information please contact:

HellermannTyton

HellermannTyton Data

Cornwell Business Park

Salhouse Road

Brackmills

Northampton

NN4 7EX

United Kingdom

Tel: +44 (0) 1604 706633

Fax: +44 (0) 1604 705454

email: sales@htdata.co.uk

web: www.htdata.co.uk